

# Transformers

## For Power Supply Pin Terminal

## SRW Series

(General Transformers, Barrierless Transformer®)

### GENERAL TRANSFORMERS, BARRIERLESS TRANSFORMER®

The SRW series transformer for switching power supplies utilizes ferrite materials, which makes it possible to achieve an incredibly high efficiency in the required frequency range.

### FEATURES

- By using high efficiency ferrite cores suitable for power conversion with very low power loss and large magnetic flux density it is possible to design transformers that is quite compact in size and high efficiency.
- A wide variety of shapes and sizes from low output to high output power, gives great flexibility of design switching power supply.
- Bobbins and other components are also available which are capable for a variety of safety regulations such as UL, CSA and VDE.

### APPLICATIONS

Transformers and Inductors for switching power supplies used for TVs, CRT Monitors, VCRs, DVDs, printers, air conditioners, AC adaptors, etc.

### PRECAUTIONARY ITEMS REGARDING THE PRODUCT

- The maximum output power is a guideline for Flyback converter topology operating at 50kHz. There may be differences depending upon the circuit topologies.
- Special ferrite materials produced for power transformers with large magnetic flux density are used in the ferrite core, so that temperature rise of transformer is within 45°C in standard design condition.
- Transformer temperature may rise even during normal operation, it is advisable that you provide a sufficient mounting distance from parts such as electrolytic capacitors, which do not withstand heat well.
- A beat sound noise may be generated even under normal operation (no harmful effect on usage).
- Please consult with us concerning usage outside of ratings.
- The products has not acquired approval for safety regulations, however, it has been constructed with materials and structures that meet with all types of safety regulations. Please consult with us about individual categories concerning the acquisition of safety regulations.
- Please make inquiries before use regarding industrial properties outside the ownership of our company regarding the contents stated here.
- When designing transformers, please feel free to contact with us concerning designs for ferrite materials and standard bobbins, which are not listed.

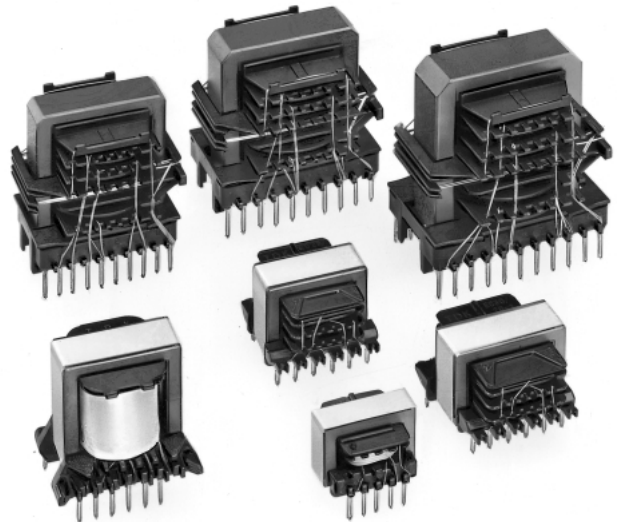

# Transformers

## For Power Supply

### Pin Terminal

# SRW Series

## (General Transformers)

### GENERAL TRANSFORMERS

#### STANDARD PRODUCTS

Shapes and Dimensions Fig. No.	Part No.	Maximum external dimensions W×D×H(mm)max.	Rated output power (W)max.	Core sectional area (cm <sup>2</sup> )	No. of terminal
1-1	SRW13ES	14×14×13.5	3	0.17	10
1-2	SRW16ES	18.5×14.5×17.5	6	0.2	10
1-3	SRW19ES	22.5×17×20	9	0.23	10
1-4	SRW25SEC	27.5×20.5×22.5	12	0.42	8
1-5	SRW2820ED-1	37×27.5×27	25	0.82	16
1-6	SRW2820ED-2	30.5×26×25	25	0.82	12
1-7	SRW2820ED-3	35×27×26.5	25	0.82	16
1-8	SRW2924ED	31×30×31	35	0.82	12
1-9	SRW2929ED	37×27.5×37.5	50	0.82	18
1-10	SRW2929ED	31×30×37	50	0.82	12
1-11	SRW3333ED	39.5×30×39.5	70	1.17	16
1-12	SRW35EC	40×31.5×50	70	1.03	20
1-13	SRW40EC	47×35×51	120	1.48	18
1-14	SRW42EC	47×35×54	160	1.86	18
1-15	SRW45LEC	50×38×65	180	1.85	18
1-16	SRW49EC	52×37×55	200	2.32	18
1-17	SRW49LEC	52×38×63	220	2.32	18
1-18	SRW13EPC	15×15×8.5	2	0.1	10
1-19	SRW17EPC	19.5×20×13	5	0.19	10
1-20	SRW19EPC	21×22×13	6	0.19	11
1-21	SRW2220EM	24×22.5×17	15	0.51	9
1-22	SRW27EM	29×29×17	15	0.44	11
1-23	SRW28EC(F)	31×38×26	30	0.77	12

• Bobbin material: UL Grade(over 94V-2), phenol

### SHAPES AND DIMENSIONS

#### 1-1.SRW13ES

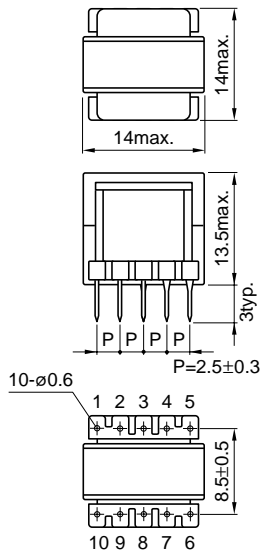

#### 1-2.SRW16ES

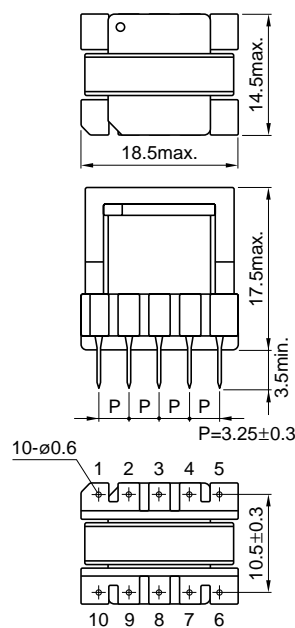

#### 1-3.SRW19ES

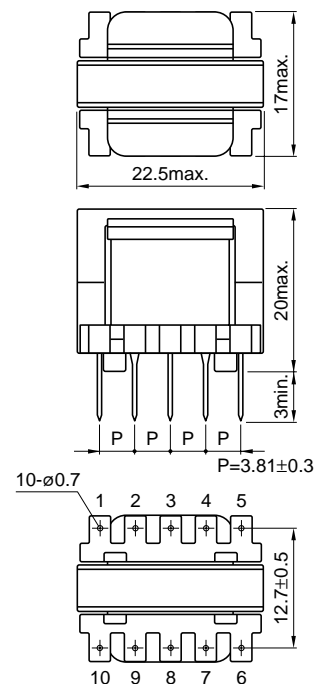

Dimensions in mm

• All specifications are subject to change without notice.

# Transformers

For Power Supply  
Pin Terminal

# SRW Series (General Transformers)

## GENERAL TRANSFORMERS SHAPES AND DIMENSIONS

1-4.SRW25SEC

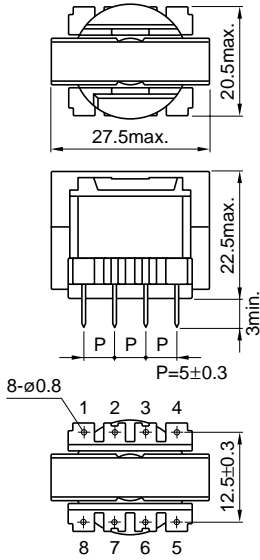

1-5.SRW2820ED-1(for VCR)

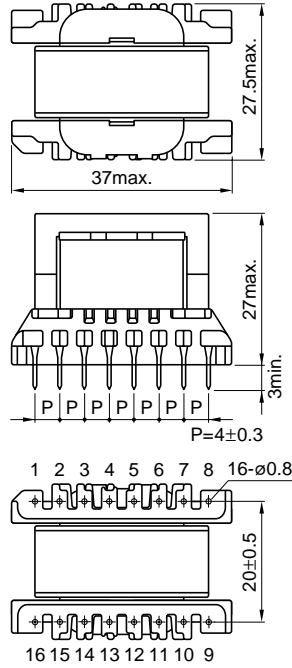

1-6.SRW2820ED-2(for adapter)

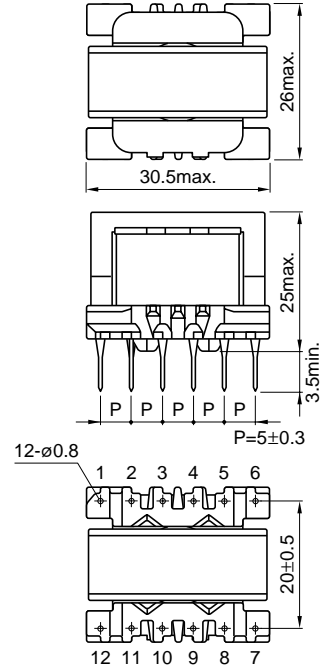

1-7.SRW2820ED-3(for air conditioner)

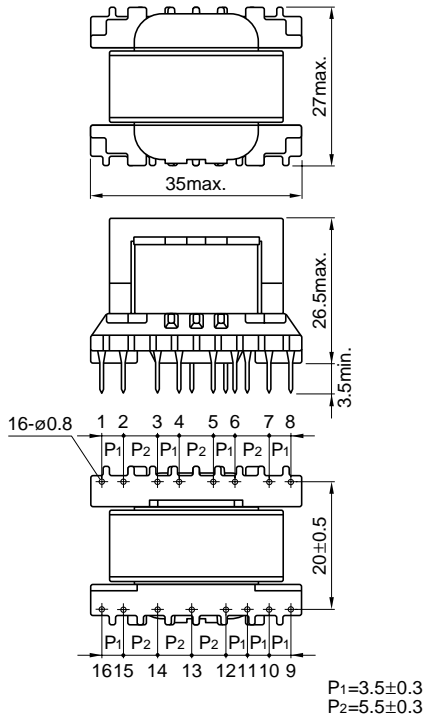

1-8.SRW2924ED

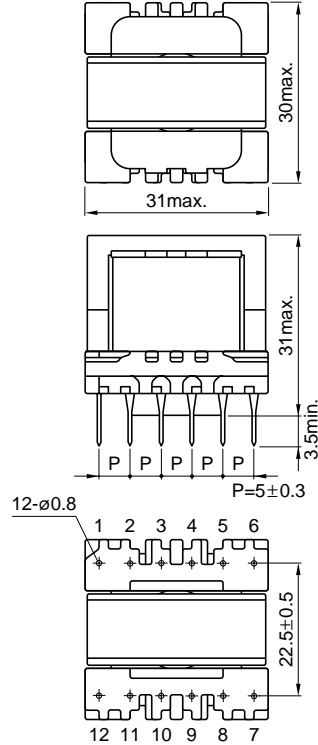

1-9.SRW2929ED(18-pin)

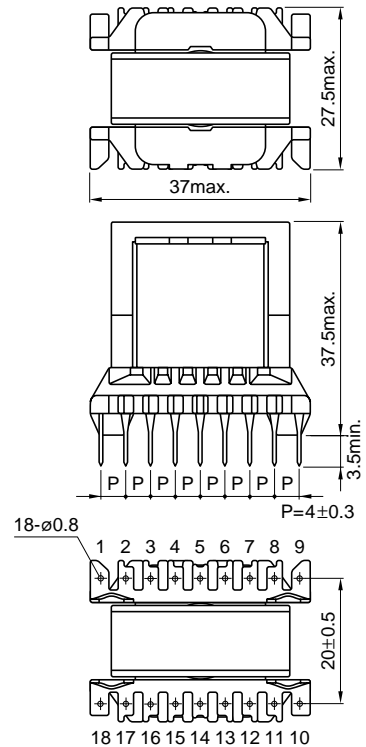

Dimensions in mm

• All specifications are subject to change without notice.

# Transformers

For Power Supply  
Pin Terminal

# SRW Series (General Transformers)

## GENERAL TRANSFORMERS SHAPES AND DIMENSIONS

1-10.SRW2929ED(12-pin)

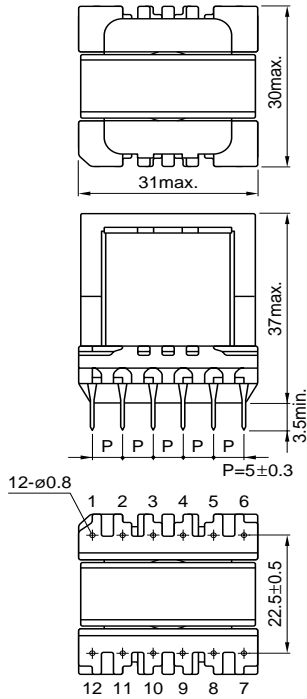

1-11.SRW3333ED

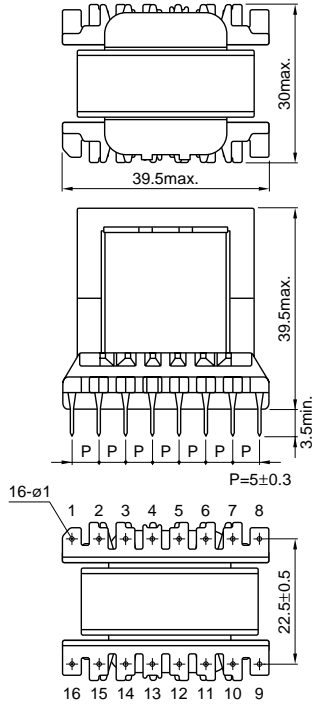

1-12.SRW35EC

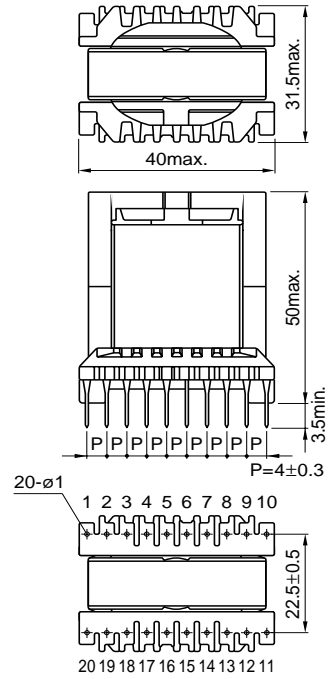

1-13 SRW40EC

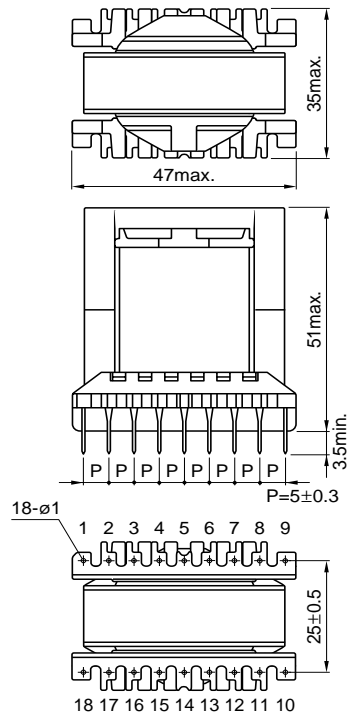

1-14 SRW42EC

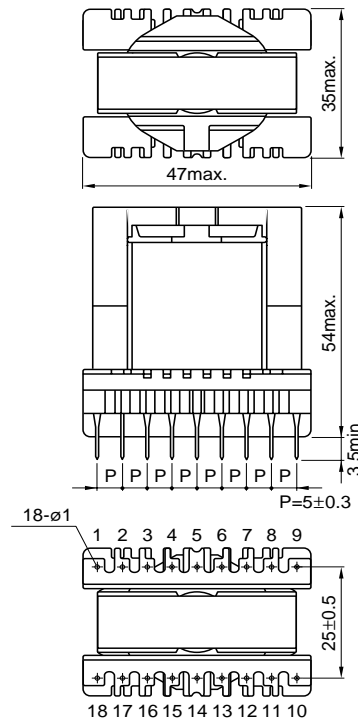

1-15 SRW45LEC

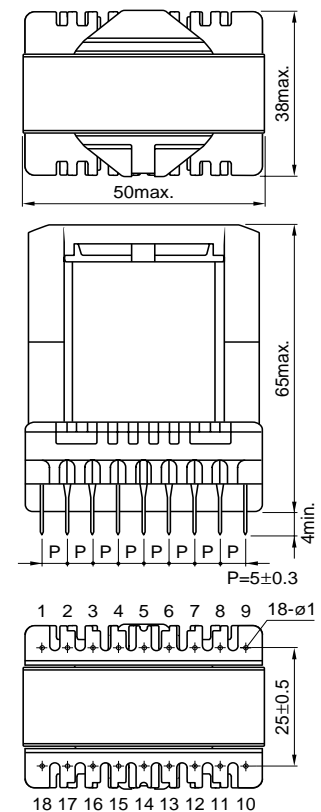

Dimensions in mm

• All specifications are subject to change without notice.

# Transformers

For Power Supply  
Pin Terminal

# SRW Series

(General Transformers)

## GENERAL TRANSFORMERS SHAPES AND DIMENSIONS

1-16.SRW49EC

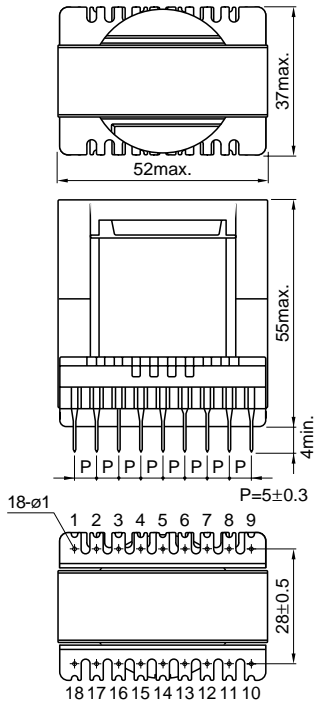

1-17.SRW49LEC

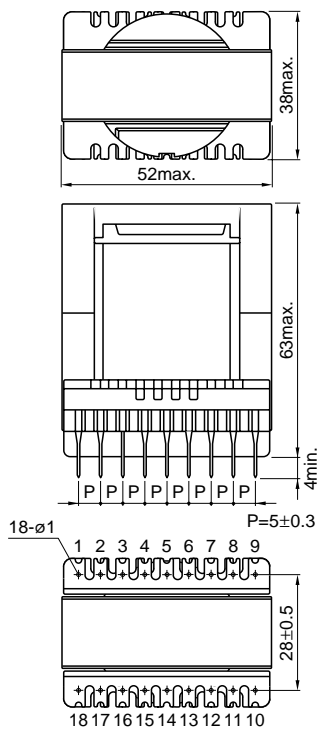

1-18.SRW13EPC

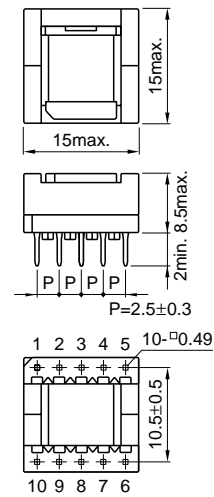

1-19.SRW17EPC

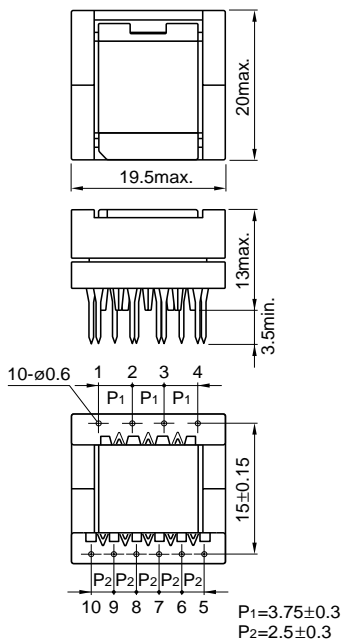

1-20.SRW19EPC

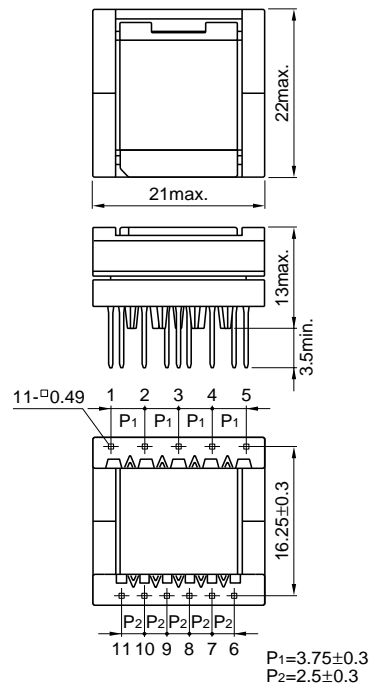

1-21.SRW2220EM

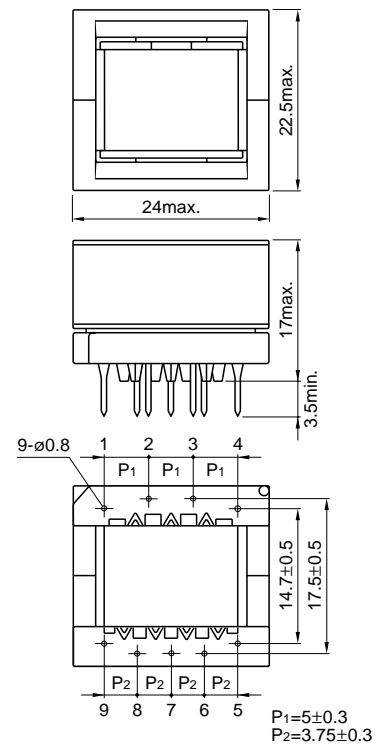

Dimensions in mm

• All specifications are subject to change without notice.

# Transformers

For Power Supply  
Pin Terminal

# SRW Series (General Transformers)

## GENERAL TRANSFORMERS SHAPES AND DIMENSIONS

### 1-22.SRW27EM

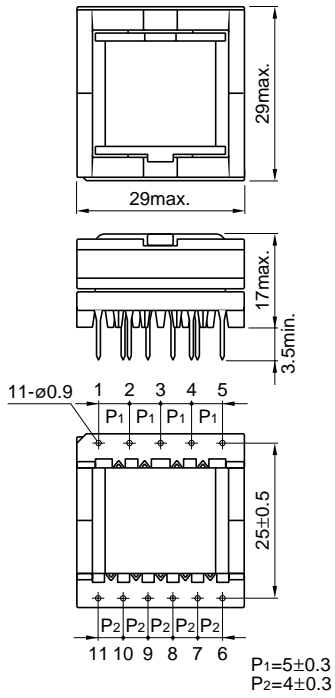

### 1-23.SRW28EC(F)

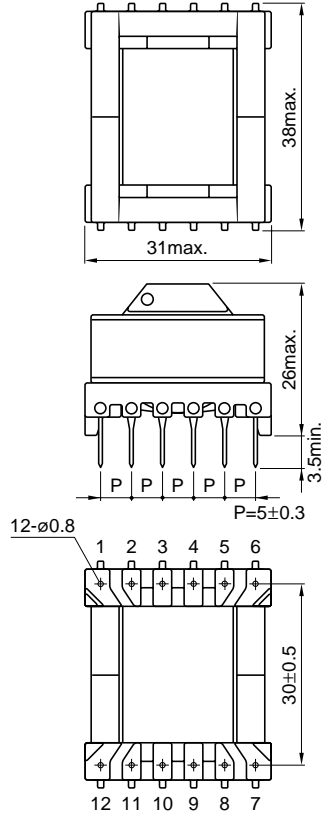

Dimensions in mm

# Transformers

## For Power Supply

### Pin Terminal

# SRW Series

## (Barrierless Transformer®)

### BARRIERLESS TRANSFORMER®

#### STANDARD PRODUCT

Shapes and dimensions Fig. No.	Part No.	Maximum external dimensions W×D×H(mm)max.	Rated output power (W)max.	Core sectional area (cm <sup>2</sup> )	Number of bobbin divisions	No. of pin terminal
2-1	SRW24ES3	25.5×20×20	15	0.5	3	9
2-2	SRW2820ED5	31×31×24	25	0.82	5	14
2-3	SRW2820ED7	33×27×26.5	25	0.82	7	16
2-4	SRW3020ED5	35.5×33×24	25	0.82	5	16
2-5	SRW3741EC9	45×36×48	80	1.03	9	20
2-6	SRW4245EC9	51×41×51	130	1.48	9	20
2-7	SRW4551EC9	55×43×58	150	1.85	9	22

### SHAPES AND DIMENSIONS

#### 2-1.SRW24ES3

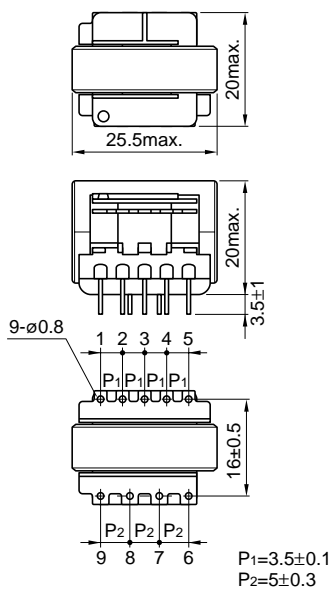

#### 2-2.SRW2820ED5(for VCR and DVD)

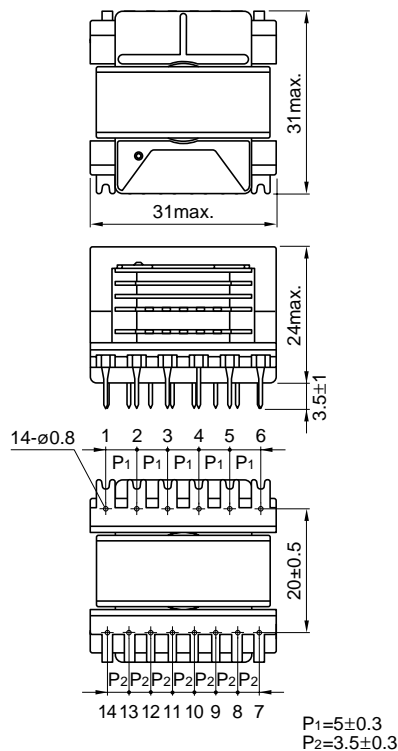

#### 2-3.SRW2820ED7(for air conditioner)

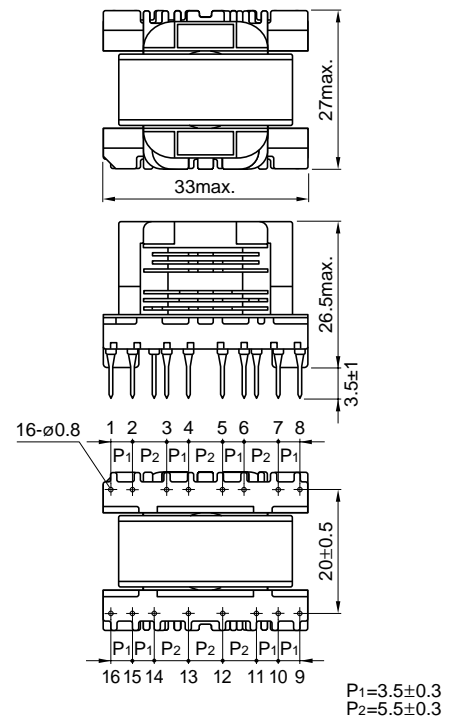

Dimensions in mm

# Transformers

For Power Supply  
Pin Terminal

# SRW Series (Barrierless Transformer®)

## BARRIERLESS TRANSFORMER® SHAPES AND DIMENSIONS

2-4.SRW3020ED5(for VCR and DVD)

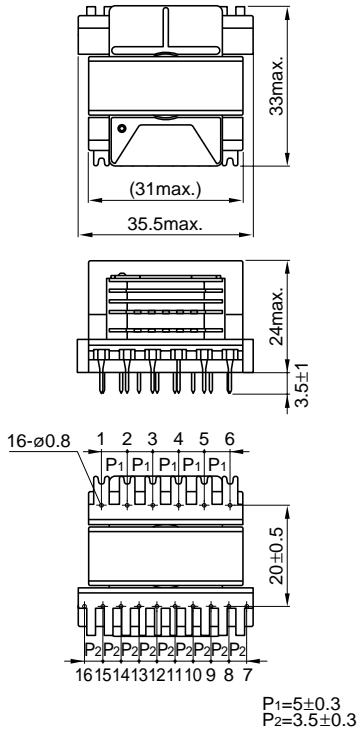

2-5.SRW3741EC9

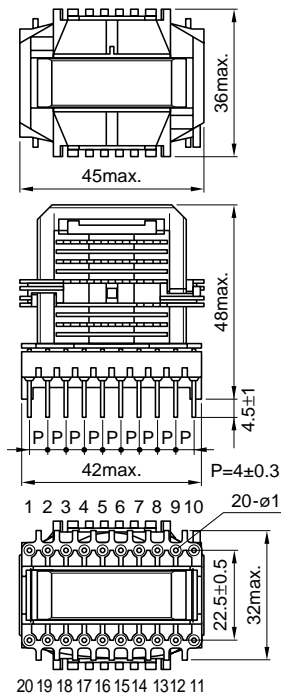

2-6.SRW4245EC9

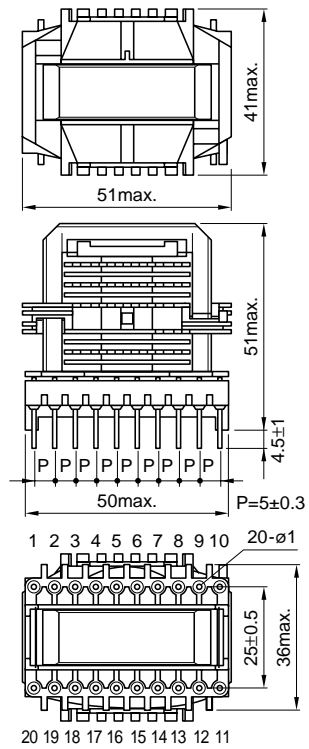

2-7.SRW4551EC9

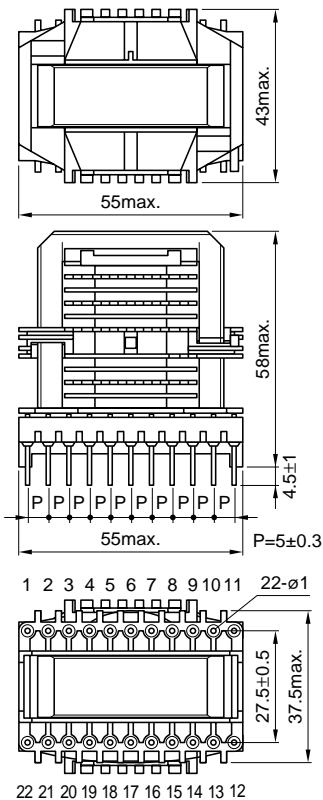

Dimensions in mm

• All specifications are subject to change without notice.



# Transformers

## For Power Supply

### Pin Terminal

## SRW Series

### (High Voltage Transformers)

#### HIGH VOLTAGE TRANSFORMERS

The SRW series transformer for switching power supplies utilizes ferrite materials, which makes it possible to achieve an incredibly high efficiency in the required frequency range.

#### FEATURES

- By using high efficiency ferrite cores suitable for power conversion with very low power loss and large magnetic flux density it is possible to design transformers that is quite compact in size and high efficiency.
- By using pressure-tight materials and highly reliable construction, we achieved to get multi-divided bobbins.

#### APPLICATIONS

- For TV's and CRT monitors.
- High-voltage transformers such as dynamic focus transformers, horizontal output transformers, and dummy coils.

#### PRECAUTIONARY ITEMS REGARDING THE PRODUCT

- The maximum output power is a guideline for Flyback converter topology operating at 50kHz. There may be differences depending upon the circuit topologies.
- Special ferrite materials produced for power transformers with large magnetic flux density are used in the ferrite core, so that temperature rise of transformer is within 45°C in standard design condition.
- Transformer temperature may rise even during normal operation, it is advisable that you provide a sufficient mounting distance from parts such as electrolytic capacitors, which do not withstand heat well.
- A beat sound noise may be generated even under normal operation (no harmful effect on usage).
- Please consult with us concerning usage outside of ratings.
- Please make inquiries before use regarding industrial properties outside the ownership of our company regarding the contents stated here.
- When designing transformers, please feel free to contact with us concerning designs for ferrite materials and standard bobbins, which are not listed.

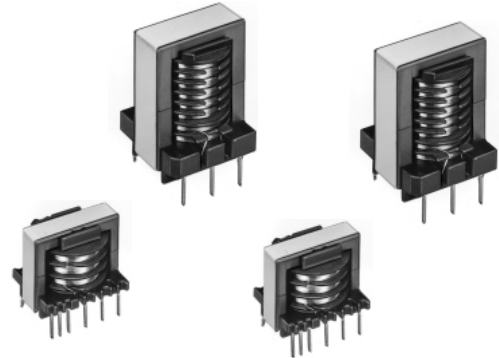

#### STANDARD PRODUCT

Shapes and dimensions Fig. No.	Part No.	Maximum external dimensions W×D×H(mm)max.	Core sectional area (cm <sup>2</sup> )	Number of bobbin divisions Primary/secondary	No. of pin terminal
3-1	SRW16ES4-H	17×16×12.5	0.19	1/3	12
3-2	SRW1916ES6-H	21×17.5×12.5	0.22	1/5	12
3-3	SRW2224ES6-H	24×26×19.5	0.33	1/5	12
3-4	SRW25SEC4-V	20×27.5×24	0.42	1/3	11
3-5	SRW28LEC8-V	26.5×31×39	0.77	2/6	5
3-6	SRW2929ED5-V	30×31×37	0.82	1/4	12

# Transformers

For Power Supply  
Pin Terminal

# SRW Series (High Voltage Transformers)

## HIGH VOLTAGE TRANSFORMERS SHAPES AND DIMENSIONS

3-1.SRW16ES4-H

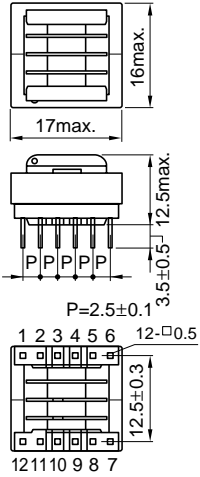

3-2.SRW1916ES6-H

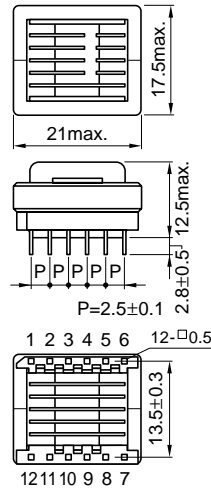

3-3.SRW2224ES6-H

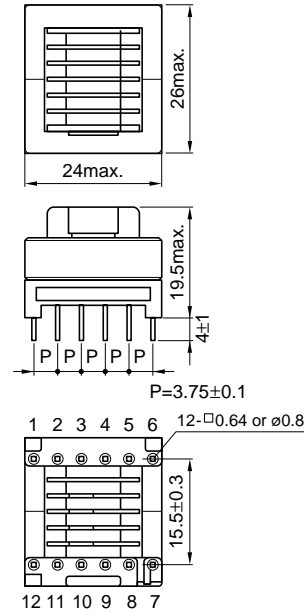

3-4.SRW25SEC4-V

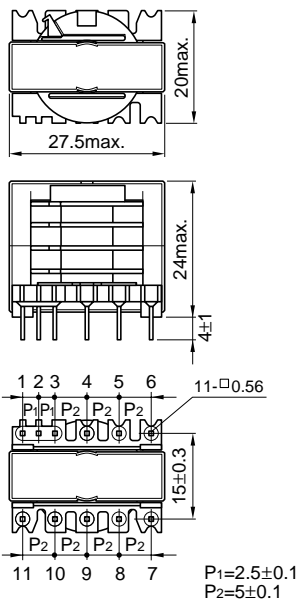

3-5.SRW28LEC8-V

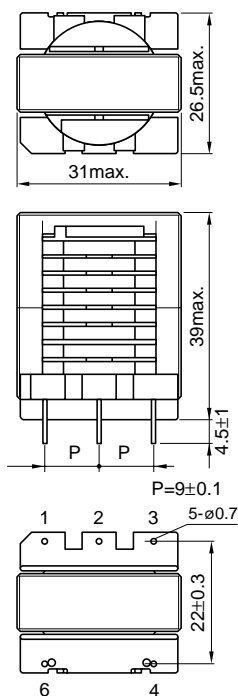

3-6.SRW2929ED5-V

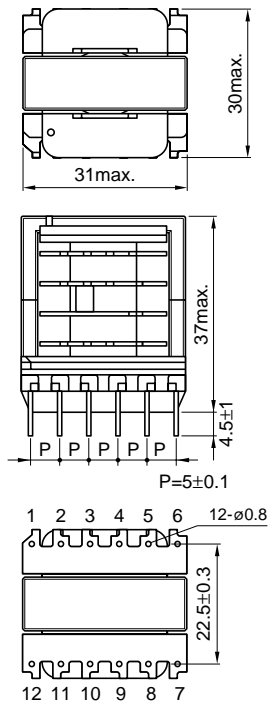

Dimensions in mm

• All specifications are subject to change without notice.

# Transformers

## For Power Supply

### Pin Terminal

## SRW Series

### (Specifications)

#### SPECIFICATIONS

Temperature ranges	Operating	-10 to +60°C
	Storage	-25 to +85°C
Humidity ranges	Operating	30 to 95(%)RH[without dewing]
	Storage	30 to 95(%)RH[without dewing]

#### GENERAL CHARACTERISTICS

Standard test conditions	Ambient temperature range	+5 to +35°C
	Relative humidity range	45 to 85(%)RH[without dewing]

Item	Standard	Test methods
Inductance	Individual specification (tolerance±10%)	Use LCR meter (f=1kHz), YHP4261 or equivalent.
DC resistance	Less than 0.05Ω: +30% max. 0.05 to 0.1Ω: +20% max. 0.1 to 0.5Ω: +15% max. 0.5Ω or more: +10% max.	Use Milliohm-meter VP2941 or equivalent.
Turn ratio and polarity	Specified value ±1 to 20%, individual specification	Use turn ratio tester TRD-0.9 (f=1 to 100kHz) or equivalent.
Withstand voltage	No abnormality between the primary and secondary windings, between the primary winding and the core, and so on.	Apply separately specified AC voltage (50Hz) for 1min.
Insulation resistance	10MΩ min.	Measure by applying DC.500V. Use insulation resistance meter SM-5E or equivalent.
Terminal strength	9.8N min.	Apply 9.8N load in the direction of terminal axis for 30±5s. Any terminal must not be pulled out or chatter.
Temperature rise	Standard design value 45°C max. (thermocouple method) 55°C max. (resistance method)	Measure the core surface by thermocouple method, and the windings by resistance method or thermocouple method.
Solderability	Solder covers more than 90%.	Dip in solder with the temperature of 230±5°C for 2±0.5s.

#### RELIABILITY TESTSRELIABILITY TESTS

Item	Standards	Test methods
Vibration resistance		Conform to JIS-C 5025. Sweep 1.5mm amplitude and 10-to-50-to-10Hz in 1min in X, Y, and Z directions for 2h respectively.
Heat resistance	Standard of inductance, insulation resistance, withstand voltage must be satisfied.	Measure in normal temperature after leaving in 100±2°C for 96h.
Cold resistance		Measure in normal temperature after leaving in -40±2°C for 96h.
Humidity resistance		Measure in normal temperature after leaving in 60±2°C and 90 to 95(%)RH for 96h.
Temperature cycle		One cycle is -25°C for 30min, normal temperature for 30min, and 85°C for 30min; measure after 10 cycles of the test have been performed.

- The above listed items are representative examples.  
The details can be found by referring to the appended individual delivery specifications.

# Transformers

## For Power Supply

### Pin Terminal

## SRW Series

### (Design reference)

#### DESIGN REFERENCE FOR SWITCHING POWER TRANSFORMERS

##### • Maximum allowable Temperature

The maximum allowable Temperature of SRW series transformer is classified in E class (120°C) in Japan. However, due to the fact that there is no classification known as E class in North America, it is classified in class 105 (105°C).

##### • Temperature rise in Transformers

In normal design condition, 55°C or less (using the resistance method) is the target of temperature rise of windings. Therefore, the maximum ambient temperature in maximum temperature rise is 65°C in Japan and 50°C for products targeted for North America. In case of measuring the temperature of the windings by thermocouple, 10 to 15°C more would be allowable.

##### • Concerning of the influence of leakage flux

Due to the fact that there is always some degree of leakage flux from transformer, designs should be made to keep them apart as much as possible from parts that are easily affected by this.

##### • Magnetic saturation of the core

(1)Magnetic operating condition of the core in the transformer are determined by maximum operation temperature (including temperature rise) and driving condition in circuits. If product is used in condition that exceed these conditions, there is a possibility of occurring magnetic saturation of the core. The following items could be possible cause of core saturation.

- The product is used in conditions that exceed the maximum operating temperature.
- Operating frequencies are lower than the ones initially designed. (longer ON time)
- The input voltage is abnormally higher than the specified values.

(2)To check on the saturation of the core it is possible to judge from current waveforms of primary winding. Current flowing in the inductor changes in a straight line in relation to time as in the figure a) in accordance with

$$I = \frac{E}{L} \times T.$$

However, in the event that a saturation phenomena has occurred in the core, inductance is reduced causing a rapid and drastic increase of current as shown figure b).

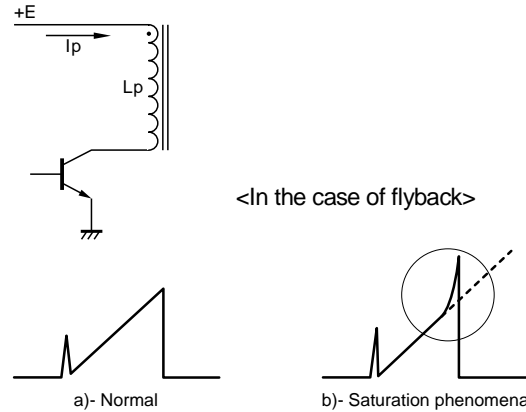

(3)In this case, there is possibility that a breakdown may occur due to surpassing the rated current of the switch it is necessary to have over current protection circuit or modify transformer design.

##### • Dealing with safety regulation

Designs are made in consideration of materials, structures and so on that the designed transformers are comply with designated safety regulations.

(1)Regarding the core

- Dentori, UL/CSA: Designed with reinforced insulation. (Depending upon the shape, Basic insulation may be applied)
- IEC65, IEC950: To be handled in the same manner as Basic Insulation.

(2)Distance between Transformer and other parts

Please keep the distance between the transformer and other parts in according with applicable safety standards.

##### • Damp proofing treatment

In order to protect the transformer against humidity as well as securing of the core and bobbin, varnish impregnation is used as standard design.

##### • Circuit topologies of switching power supply

The term "topology" refers to the arrangement of the power components within the switching power supply design. There are several different kind of circuit topologies as following;

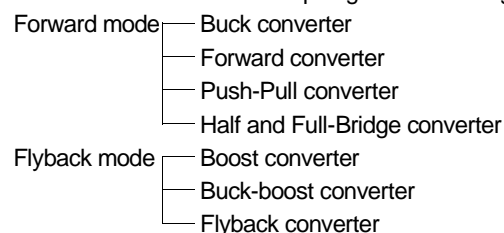

# Transformers

## For Power Supply

### Pin Terminal

## SRW Series

### (Design reference)

#### DESIGN REFERENCE FOR SWITCHING POWER TRANSFORMERS

##### • Which topology of switching power supply to use?

Each topology has its relative merit in terms of cost and performance. One topology may have a low parts cost but only be able to provide a limited amount of power; another may have ample power capability but cost more, and so on.

The following relationship between output voltage and power give us one suggestion when we need to chose topology in given conditions;

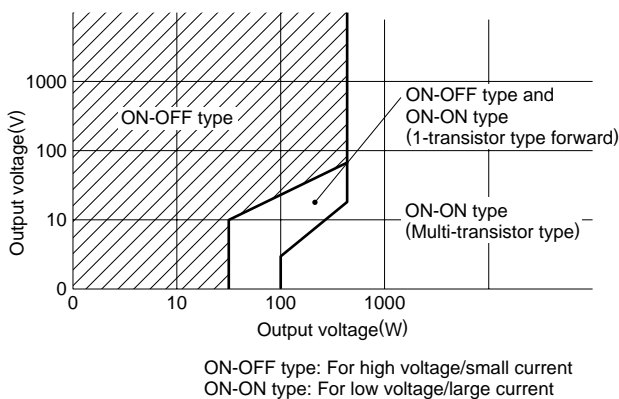

##### • The difference of power conversion between Forward and Flyback mode.

Since the forward mode converter is a system that performs power transmission to the output side during ON period of switching transistor, it is possible to work with the large output current. Consequently, forward converter method is suitable to large current output with relatively lower output voltage.

To the contrary, Flyback mode converter is a system that input power is stored within the Inductor or primary coil in the transformer as a magnetic energy during ON period of switching transistor and the stored energy transmit to output side during OFF period of switching transistor. Accordingly, Flyback mode converter is suitable to high voltage and low current output, and does not suite to large current output.

##### • The stored energy within the inductor.

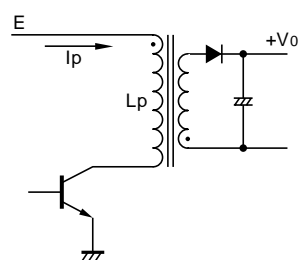

The stored energy in the inductor

$$W = \frac{1}{2} \times L_p \times I_p^2 \text{ [J]}$$

and thus the power is the energy per unit time, resulting in

$$P = \frac{\text{[J]}}{\text{[S]}} = \frac{1}{2} \times L_p \times I_p^2 \times f \text{ [W]}$$

Where,

$L_p$ : Inductance of primary winding

$I_p$ : Peak value of primary current

$f$ : Switching frequency

##### • How to decide primary inductance ( $L_p$ ) in Flyback converter.

Using the formula  $P = \frac{1}{2} \times L_p \times I_p^2 \times f \text{ [W]}$ , it is possible to calculate the inductance value needed for the desired output  $P$  under the fixed  $I_p$  value.

By deriving  $E \times T = L_p \times i$  from the formula  $E = L_p \times \frac{di}{dt}$ , the current

which flows through the inductor becomes  $i = \frac{E \times T}{L_p}$ .

By substituting this with  $P = \dots$ , the formula of

$$P = \frac{1}{2} \times L_p \times \left( \frac{E \times T}{L_p} \right)^2 \times f = \frac{1}{2} \times \frac{E^2 \times T^2}{L_p} \times f \text{ results.}$$

From this, the formula  $L_p = \frac{E^2 \times T^2}{2 \times P} \times f$  results.

Where,

$E$ : Input voltage

$T$ : On time

$f$ : Switching frequency

In actual designs this value is to be slightly lowered in consideration of the transformer's efficiency.

##### • How to decide number of turns of primary winding

(1) Flyback converter

$$N_p = \frac{E_{\min} \times T_{\max}}{\Delta B \times A}$$

Where,

$E_{\min}$ : Lower limit value of input voltage [Vdc]

$A$ : Core cross section area [m<sup>2</sup>]

$D$ : Duty ratio

$T_{\max}$ : The maximum ON time for switching transistor [sec.]

$\Delta$ : Operating flux density [T]

Precautions must be taken as the upper limit value of  $\Delta B$  changes according to core materials, operating temperatures, frequencies, etc.

(2) Forward converter

The calculation formula of primary winding  $N_p$  is same as in case (1). However, in accordance with separate excitation, the ON time ( $T_{\max}$ ) should be lower than 45% of switching period. Further, it is necessary to consider the residual magnetic flux density of the core,  $\Delta B$  should be slightly lower than that with the flyback converter.

# Transformers

## For Power Supply

### Pin Terminal

# SRW Series

## (Design reference)

### DESIGN REFERENCE FOR SWITCHING POWER TRANSFORMERS

#### • Determining of secondary winding

##### (1) Flyback converter

As it is necessary to consider the voltage drop of the rectifier diode on the secondary side,

$$N_s = N_p \times \frac{V_o + V_F}{E_{min.}} \times \frac{1-D}{D}$$

Where,

V<sub>F</sub>: Voltage drop of the rectifier diode

##### (2) Forward converter

Output filter inductor must be used at secondary side in the forward converter, the voltage drop of the inductor also need to be considered, resulting,

$$N_s = N_p \times \frac{(V_o + V_F + V_L) \times 1/D}{E_{min.}}$$

Where,

V<sub>L</sub>: Voltage drop of the Output filter inductor

#### • Example of drive waveforms

Ringing choke system circuit (RCC)

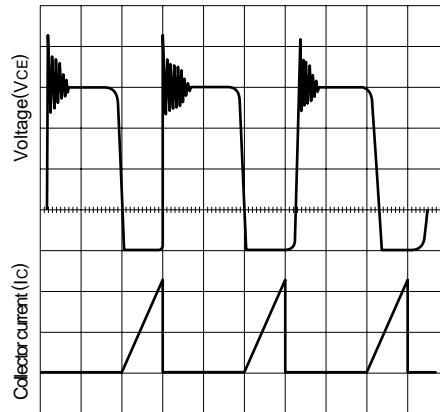
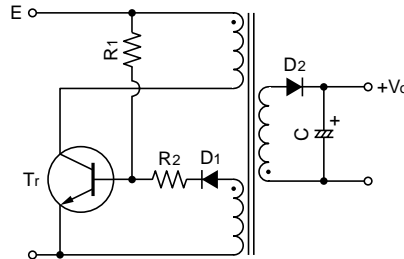

1-transistor forward type converter

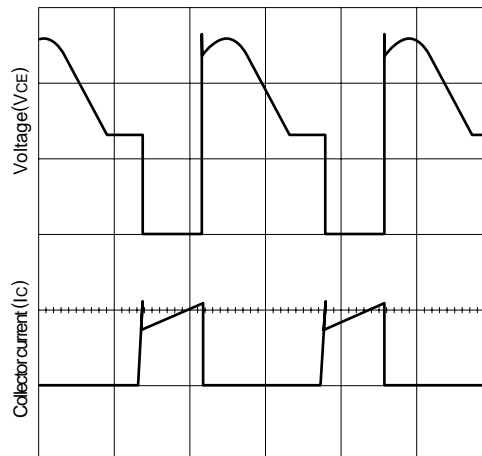
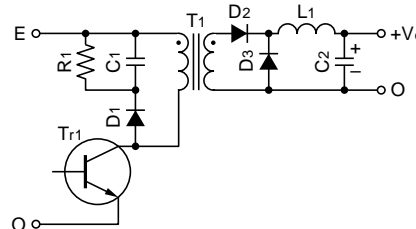

---

# Transformers

## For Power Supply

### Pin Terminal

---

## SRW Series

### (Design reference)

---

- **In order for designing the transformer, the following conditions are necessary.**

It is greatly appreciated customer give us those conditions by filling out required information with the appended "Transformer specifications / inquiry form".

(1) Circuit topology

Flyback type, forward type, push-pull, half-bridge, etc

(2) Input voltage range

The lower limit of rectified voltage is important, in particular.

(3) Operating frequency

It is especially necessary to determine the lower limit frequency for the maximum load condition in Flyback converter.

(4) Maximum duty ratio

It is necessary to specify maximum ON time when input voltage is lower limit, approximately 45% should be the maximum for external excitation system.

(5) Maximum temperature rise

This is the allowable temperature rise in the transformer, should be equal to the value that ambient temperature has been taken from the temperature index of the materials which is 120°C(105°C in UL system).

(6) Required safety regulations

Structures and materials are chosen to comply with required safety regulations.

(7) Output voltage/current

Required for determination of the winding ratios and wire gage.

(8) Instructions concerning circuit designs and pin configuration of transformer

Type of the secondary rectifier diode is important in particular because of voltage drop between First recovery and Schottky barrier type is different, it will affect to design of number of turns of transformer.