



# BIPOLAR ANALOG INTEGRATED CIRCUIT

# $\mu$ PC8240T6N

## SiGe:C LOW NOISE AMPLIFIER FOR GPS

### DESCRIPTION

The  $\mu$ PC8240T6N is a silicon germanium carbon (SiGe:C) monolithic integrated circuit low noise amplifier for GPS. This device exhibits low noise figure and high gain characteristics, to improve the sensitivity of GPS receivers. The  $\mu$ PC8240T6N contains the output matching circuit to reduce external components and system size.

The package is a 6-pin plastic TSON (Thin Small Out-line Non-leaded) (T6N) suitable for surface mounting.

This IC is manufactured using our UHS4 (Ultra High Speed Process) SiGe:C bipolar process.

### FEATURES

- Supply Voltage :  $V_{CC} = 1.6$  to  $3.3$  V (2.7 V TYP.)
- Low Noise Figure : NF = 1.0 dB TYP. @  $V_{CC} = 2.7$  V,  $f_{in} = 1$  575 MHz  
: NF = 1.0 dB TYP. @  $V_{CC} = 1.8$  V,  $f_{in} = 1$  575 MHz
- High Gain :  $G_P = 28$  dB TYP. @  $V_{CC} = 2.7$  V,  $f_{in} = 1$  575 MHz  
:  $G_P = 27$  dB TYP. @  $V_{CC} = 1.8$  V,  $f_{in} = 1$  575 MHz
- Low current consumption :  $I_{CC} = 6.5$  mA TYP. @  $V_{CC} = 2.7$  V
- Built-in power-saving function :  $V_{PSON} = 1.0$  V to  $V_{CC}$ ,  $V_{PSOFF} = 0$  to  $0.4$  V
- High-density surface mounting : 6-pin plastic TSON (T6N) package ( $1.5 \times 1.5 \times 0.37$  mm)
- Included output matching circuit
- Included very robust bandgap regulator (Small  $V_{CC}$  and  $T_A$  dependence)
- Included protection circuits for ESD

### APPLICATION

- Low noise amplifier for GPS

### ORDERING INFORMATION

Part Number	Order Number	Package	Marking	Supplying Form
$\mu$ PC8240T6N-E2	$\mu$ PC8240T6N-E2-A	6-pin plastic TSON (T6N) (Pb-Free)	C3T	<ul style="list-style-type: none"><li>• 8 mm wide embossed taping</li><li>• Pin 1, 6 face the perforation side of the tape</li><li>• Qty 3 kpcs/reel</li></ul>

**Remark** To order evaluation samples, contact your nearby sales office.

Part number for sample order:  $\mu$ PC8240T6N-A

**Caution: Observe precautions when handling because these devices are sensitive to electrostatic discharge**

The information in this document is subject to change without notice. Before using this document, please confirm that this is the latest version.

**PIN CONNECTIONS AND INTERNAL BLOCK DIAGRAM**

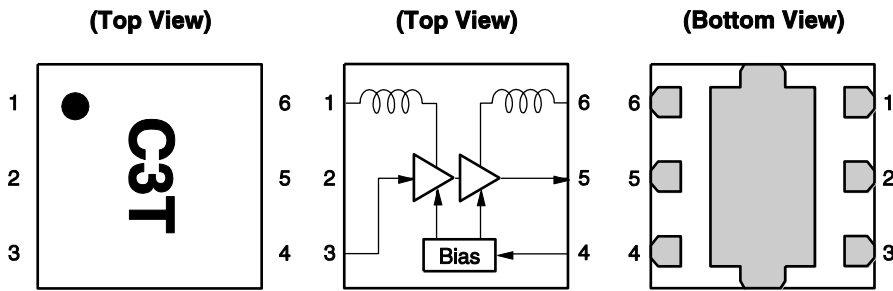

Pin No.	Pin Name
1	V <sub>CC</sub>
2	GND
3	INPUT
4	Power Save
5	OUTPUT
6	V <sub>CC</sub>

Remark Exposed pad : GND

**ABSOLUTE MAXIMUM RATINGS**

Parameter	Symbol	Test Conditions	Ratings	Unit
Supply Voltage	V <sub>CC</sub>	T <sub>A</sub> = +25°C	4.0	V
Power-Saving Voltage	V <sub>PS</sub>	T <sub>A</sub> = +25°C	4.0	V
Total Power Dissipation	P <sub>tot</sub>		150	mW
Operating Ambient Temperature	T <sub>A</sub>		-40 to +85	°C
Storage Temperature	T <sub>stg</sub>		-55 to +150	°C
Input Power	P <sub>in</sub>		+10	dBm

**RECOMMENDED OPERATING RANGE**

Parameter	Symbol	MIN.	TYP.	MAX.	Unit
Supply Voltage	V <sub>CC</sub>	1.6	2.7	3.3	V
Operating Ambient Temperature	T <sub>A</sub>	-40	+25	+85	°C
Power Save Turn-on Voltage	V <sub>PSon</sub>	1.0	-	V <sub>CC</sub>	V
Power Save Turn-off Voltage	V <sub>PSoff</sub>	0	-	0.4	V

**ELECTRICAL CHARACTERISTICS**

(T<sub>A</sub> = +25°C, V<sub>CC</sub> = V<sub>PS</sub> = 2.7 V, f<sub>in</sub> = 1 575 MHz, unless otherwise specified)

Parameter	Symbol	Test Conditions	MIN.	TYP.	MAX.	Unit
Circuit Current	I <sub>CC</sub>	No Signal (V <sub>PS</sub> = 2.7 V)	4.5	6.5	9.0	mA
		At Power-Saving Mode (V <sub>PS</sub> = 0 V)	-	-	1	μA
Power Gain	G <sub>P</sub>	P <sub>in</sub> = -35 dBm	24.5	28	31	dB
Noise Figure	NF		-	1.0	1.3	dB
Input Return Loss	RL <sub>in</sub>		6.5	8.5	-	dB
Output Return Loss	RL <sub>out</sub>		10	17	-	dB

**STANDARD CHARACTERISTICS FOR REFERENCE 1**

( $T_A = +25^\circ\text{C}$ ,  $V_{CC} = V_{PS} = 2.7\text{ V}$ ,  $f_{in} = 1\ 575\text{ MHz}$ , unless otherwise specified)

Parameter	Symbol	Test Conditions	Reference	Unit
Input 3rd Order Intercept Point	IIP <sub>3</sub>	$f_{in1} = 1\ 575\text{ MHz}$ , $f_{in2} = 1\ 574\text{ MHz}$	-21.5	dBm
Isolation	ISL		55	dB
Gain 1 dB Compression Input Power	$P_{in(1\text{ dB})}$		-22.5	dBm

**STANDARD CHARACTERISTICS FOR REFERENCE 2**

( $T_A = +25^\circ\text{C}$ ,  $V_{CC} = V_{PS} = 1.8\text{ V}$ ,  $f_{in} = 1\ 575\text{ MHz}$ , unless otherwise specified)

Parameter	Symbol	Test Conditions	Reference	Unit
Circuit Current	I <sub>CC</sub>	No Signal ( $V_{PS} = 1.8\text{ V}$ )	6.2	mA
Power Gain	G <sub>P</sub>	$P_{in} = -35\text{ dBm}$	27	dB
Noise Figure	NF		1.0	dB
Input Return Loss	RL <sub>in</sub>		8.5	dB
Output Return Loss	RL <sub>out</sub>		16.5	dB
Input 3rd Order Intercept Point	IIP <sub>3</sub>	$f_{in1} = 1\ 575\text{ MHz}$ , $f_{in2} = 1\ 574\text{ MHz}$	-21.5	dBm
Isolation	ISL		55	dB
Gain 1 dB Compression Input Power	$P_{in(1\text{ dB})}$		-26.5	dBm

**TEST CIRCUIT**

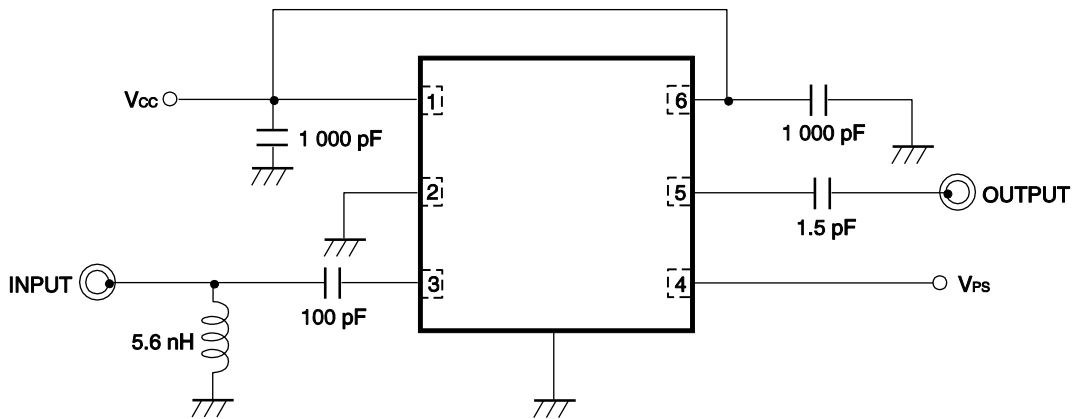

TYPICAL CHARACTERISTICS ( $T_A = +25^\circ\text{C}$ , unless otherwise specified)

CIRCUIT CURRENT vs. SUPPLY VOLTAGE

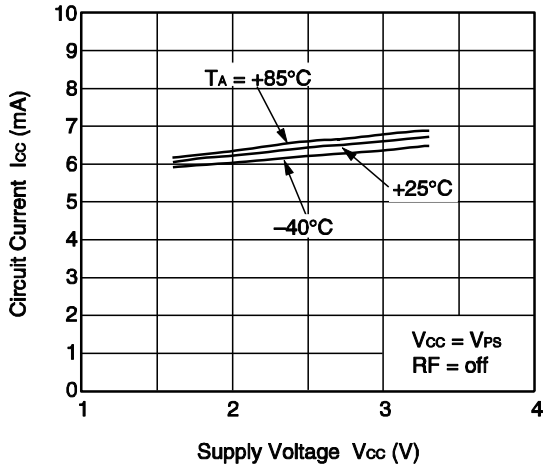

CIRCUIT CURRENT vs. OPERATING AMBIENT TEMPERATURE

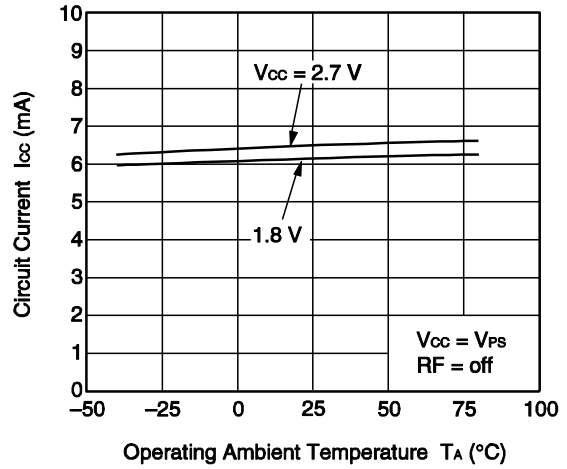

CIRCUIT CURRENT vs. POWER-SAVING VOLTAGE

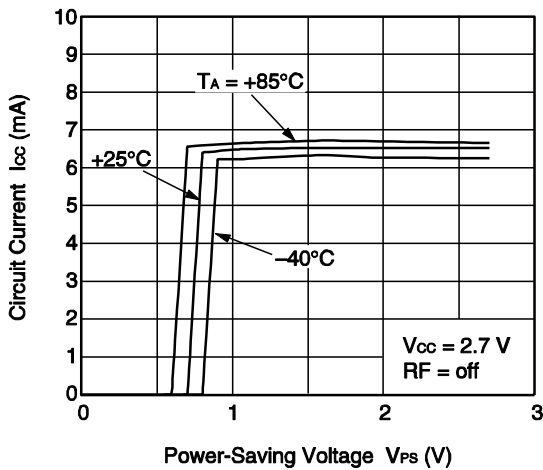

CIRCUIT CURRENT vs. POWER-SAVING VOLTAGE

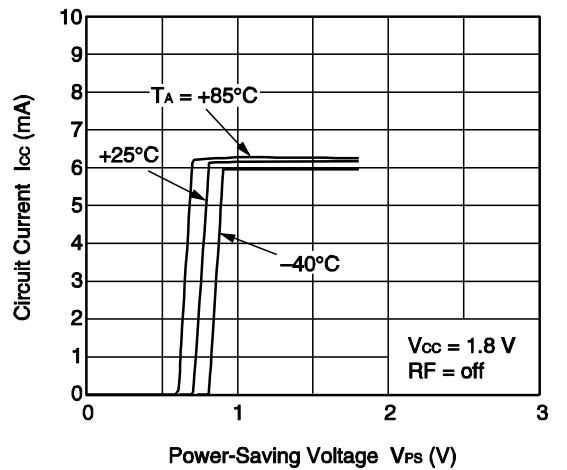

POWER GAIN vs. FREQUENCY

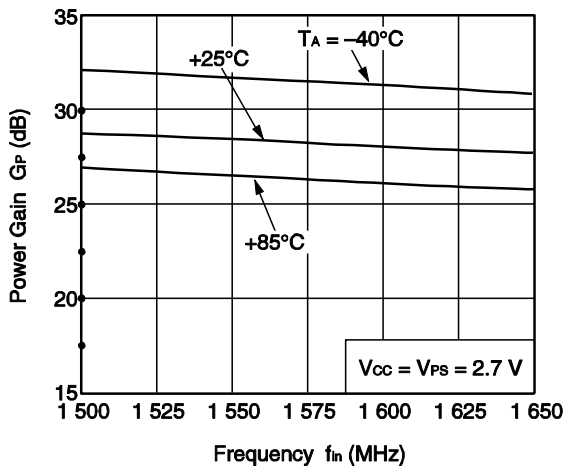

NOISE FIGURE vs. FREQUENCY

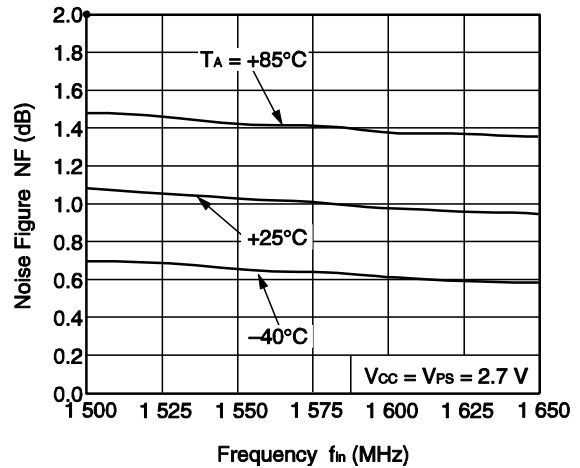

Remark The graphs indicate nominal characteristics.

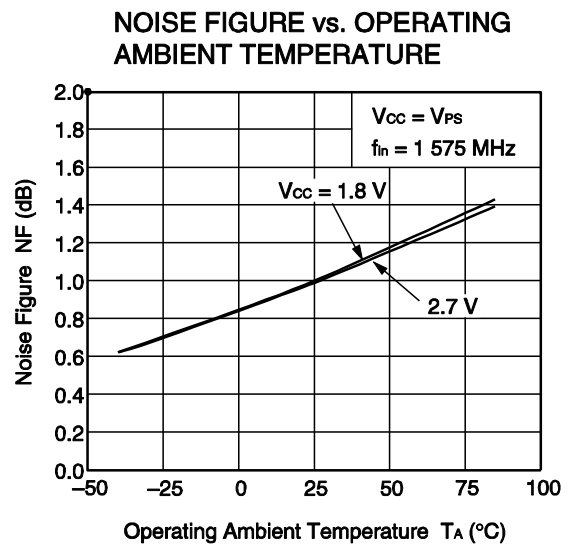
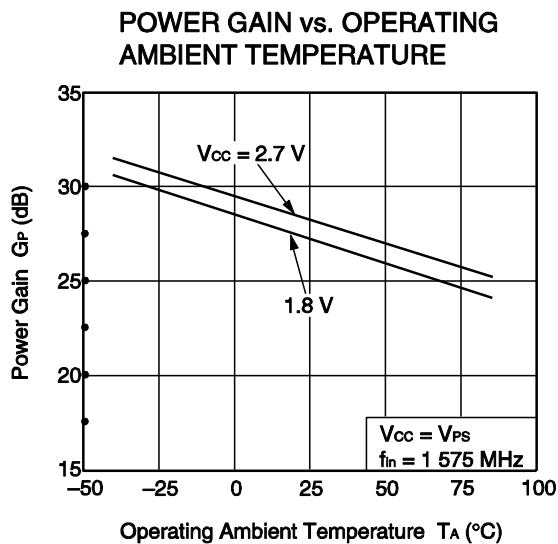
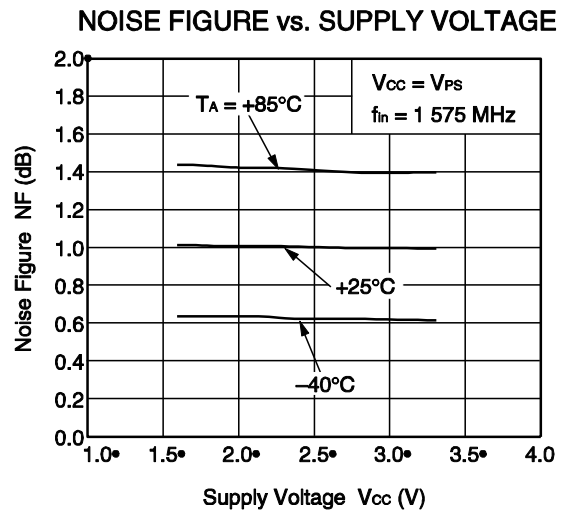
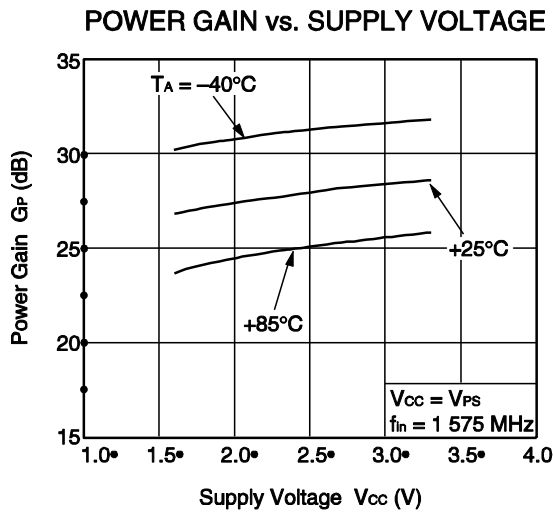
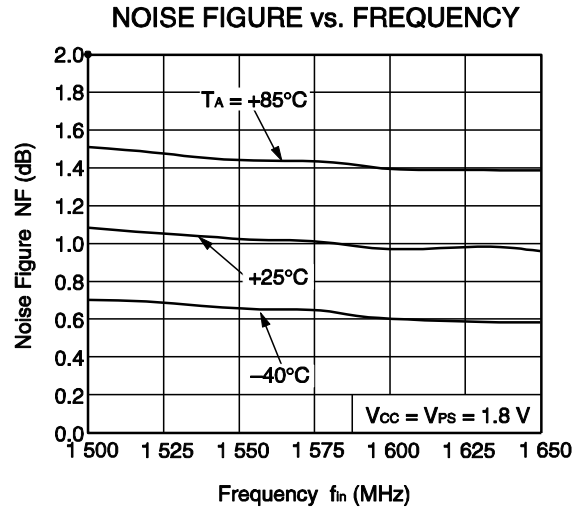
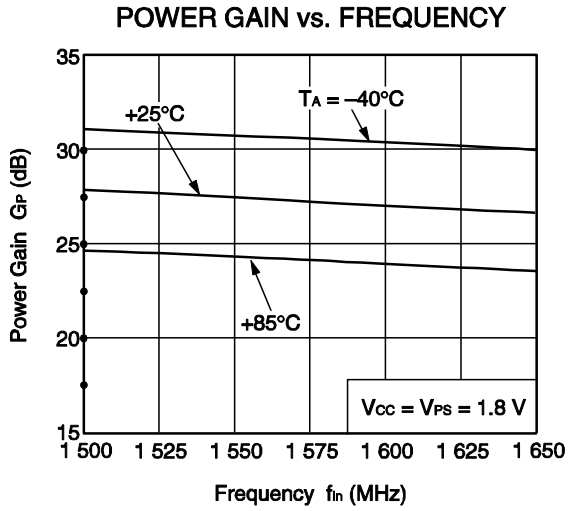

Remark The graphs indicate nominal characteristics.

OUTPUT POWER vs. INPUT POWER

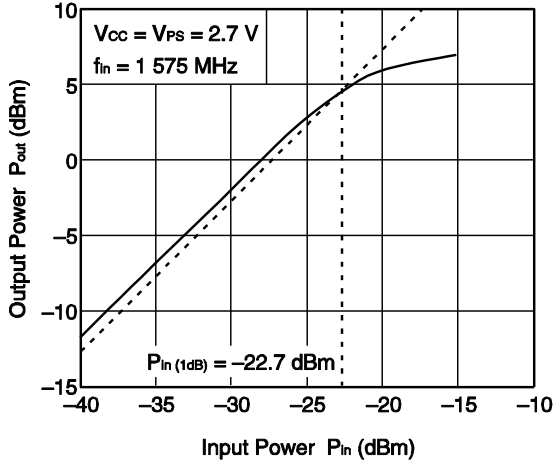

OUTPUT POWER vs. INPUT POWER

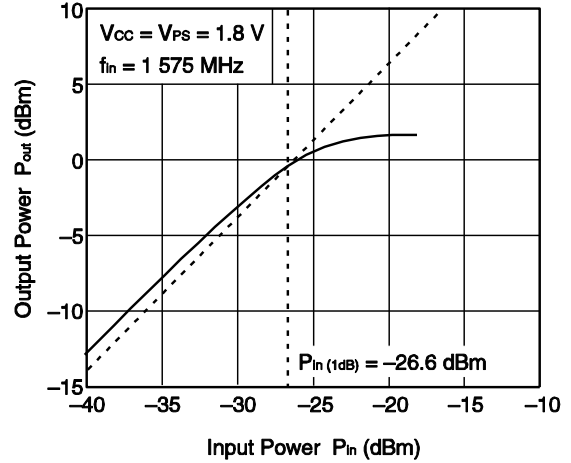

POWER GAIN, CIRCUIT CURRENT vs. INPUT POWER

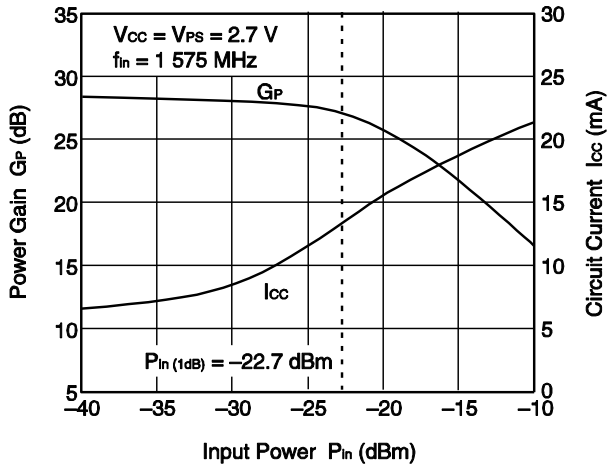

POWER GAIN, CIRCUIT CURRENT vs. INPUT POWER

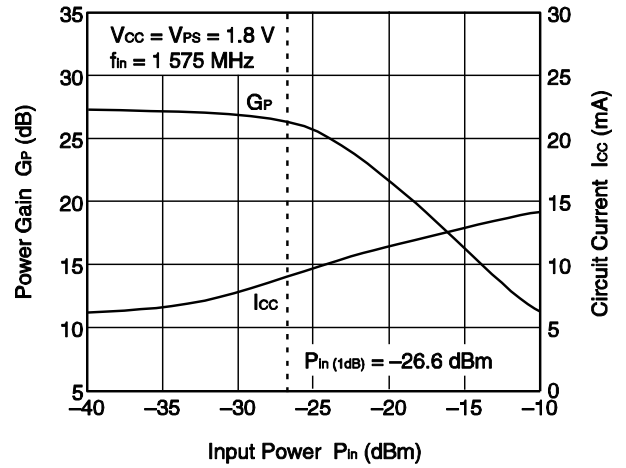

OUTPUT POWER, IM3 vs. INPUT POWER

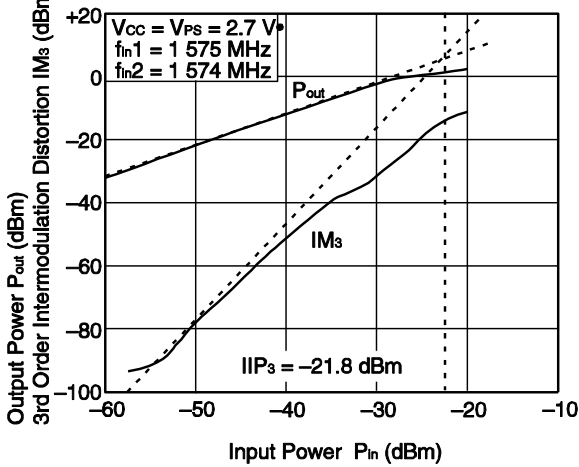

OUTPUT POWER, IM3 vs. INPUT POWER

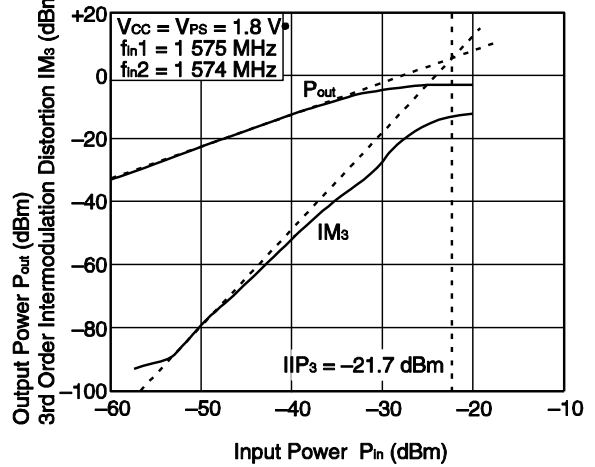

Remark The graphs indicate nominal characteristics.

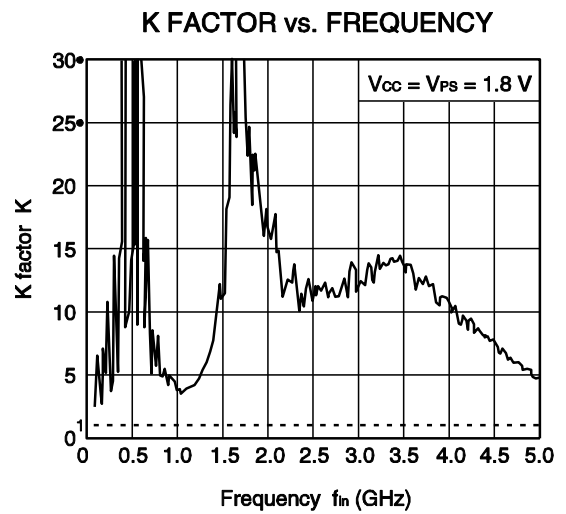
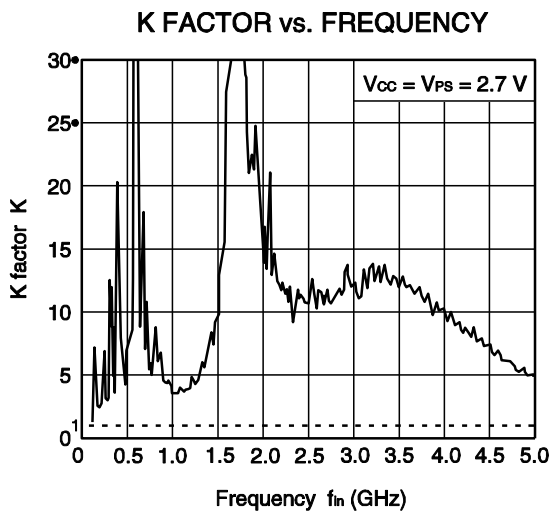
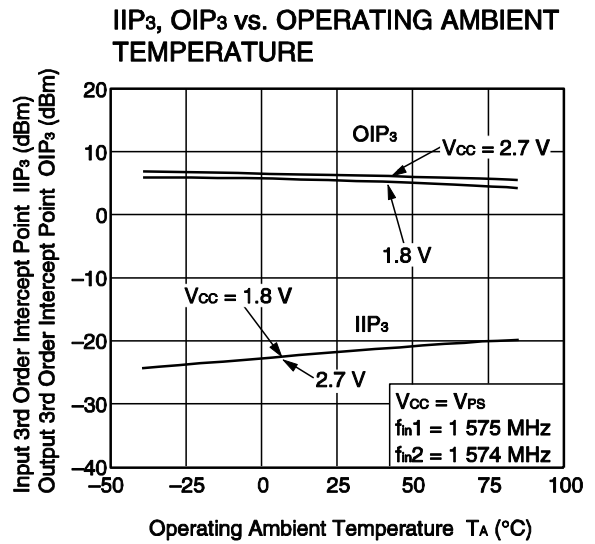
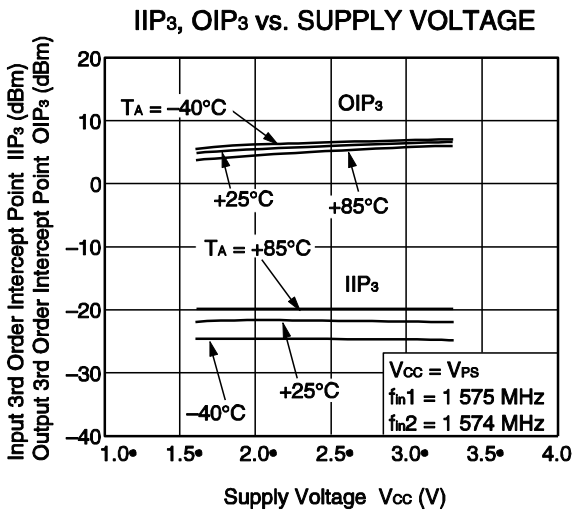
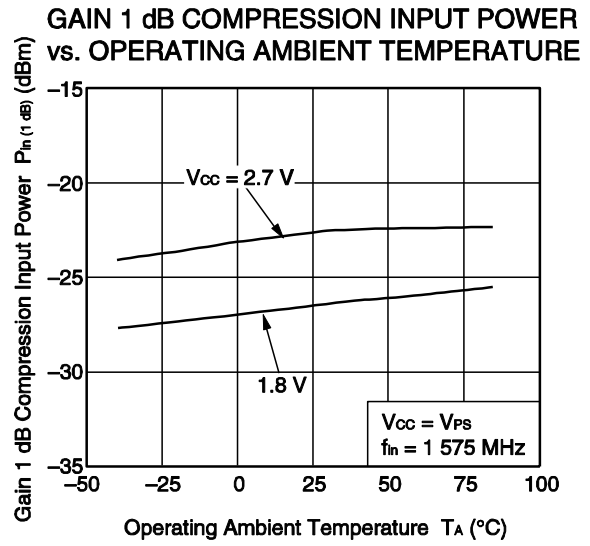
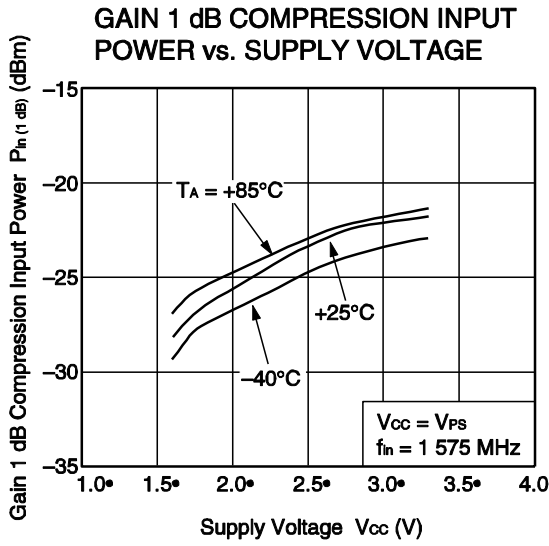

**Remark** The graphs indicate nominal characteristics.

S-PARAMETERS ( $T_A = +25^\circ\text{C}$ ,  $V_{CC} = V_{PS} = 2.7\text{ V}$ , monitored at connector on board)

S<sub>11</sub>-FREQUENCY

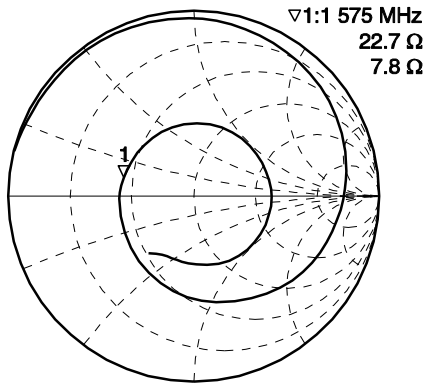

START 100.000 000 MHz STOP 5 000.000 000 MHz

S<sub>22</sub>-FREQUENCY

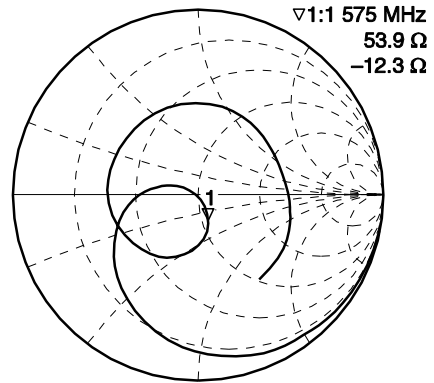

START 100.000 000 MHz STOP 5 000.000 000 MHz

INPUT RETURN LOSS vs. FREQUENCY

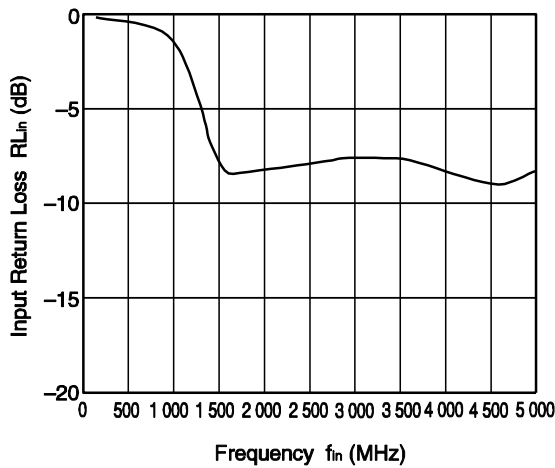

OUTPUT RETURN LOSS vs. FREQUENCY

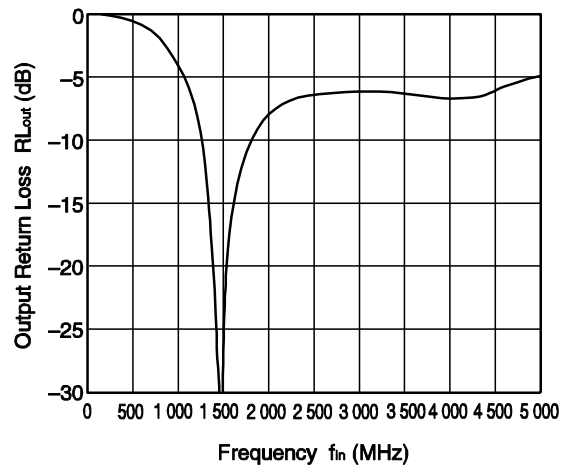

POWER GAIN vs. FREQUENCY

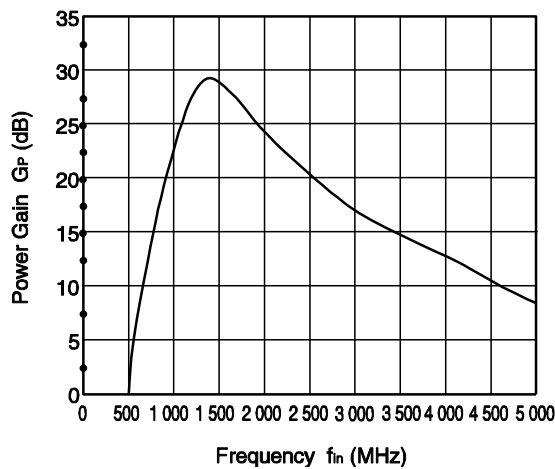

ISOLATION vs. FREQUENCY

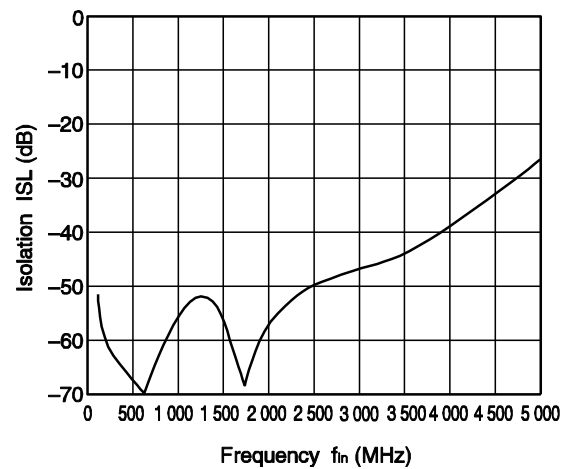

**Remark** The graphs indicate nominal characteristics.



S-PARAMETERS ( $T_A = +25^\circ\text{C}$ ,  $V_{CC} = V_{PS} = 1.8\text{ V}$ , monitored at connector on board)

S<sub>11</sub>-FREQUENCY

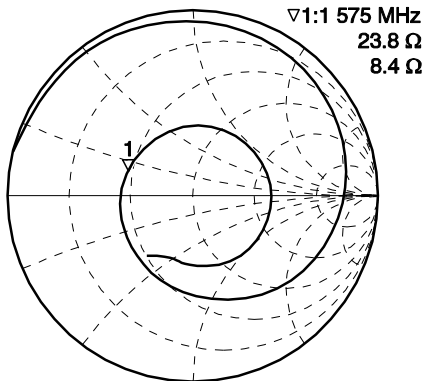

START 100.000 000 MHz STOP 5 000.000 000 MHz

S<sub>22</sub>-FREQUENCY

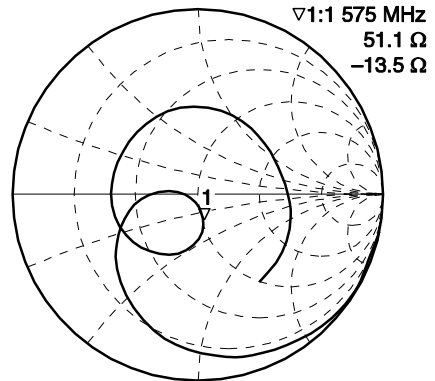

START 100.000 000 MHz STOP 5 000.000 000 MHz

INPUT RETURN LOSS vs. FREQUENCY

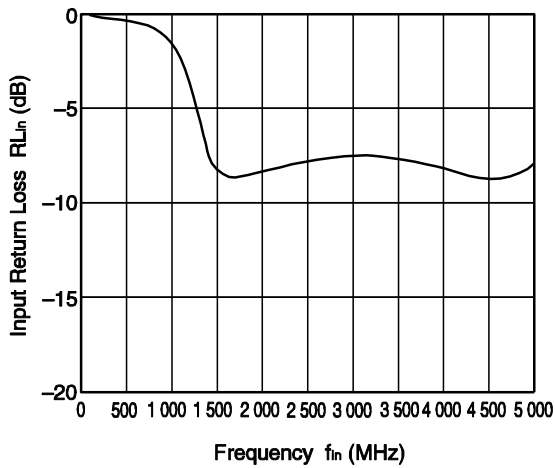

OUTPUT RETURN LOSS vs. FREQUENCY

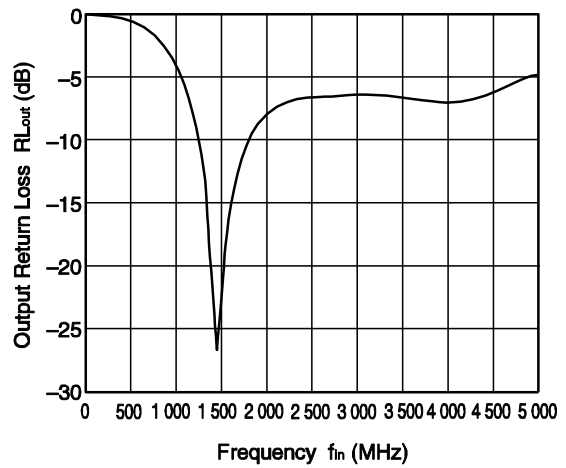

POWER GAIN vs. FREQUENCY

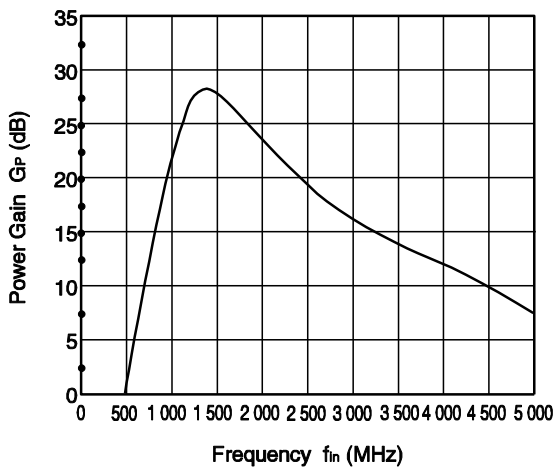

ISOLATION vs. FREQUENCY

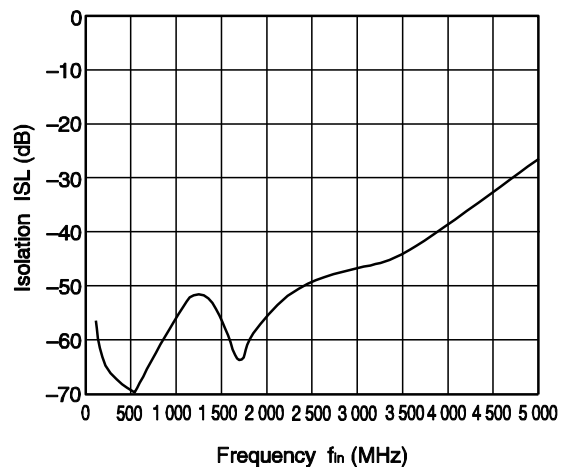

**Remark** The graphs indicate nominal characteristics.

**PACKAGE DIMENSIONS**

**6-PIN PLASTIC TSON (T6N) (UNIT: mm)**

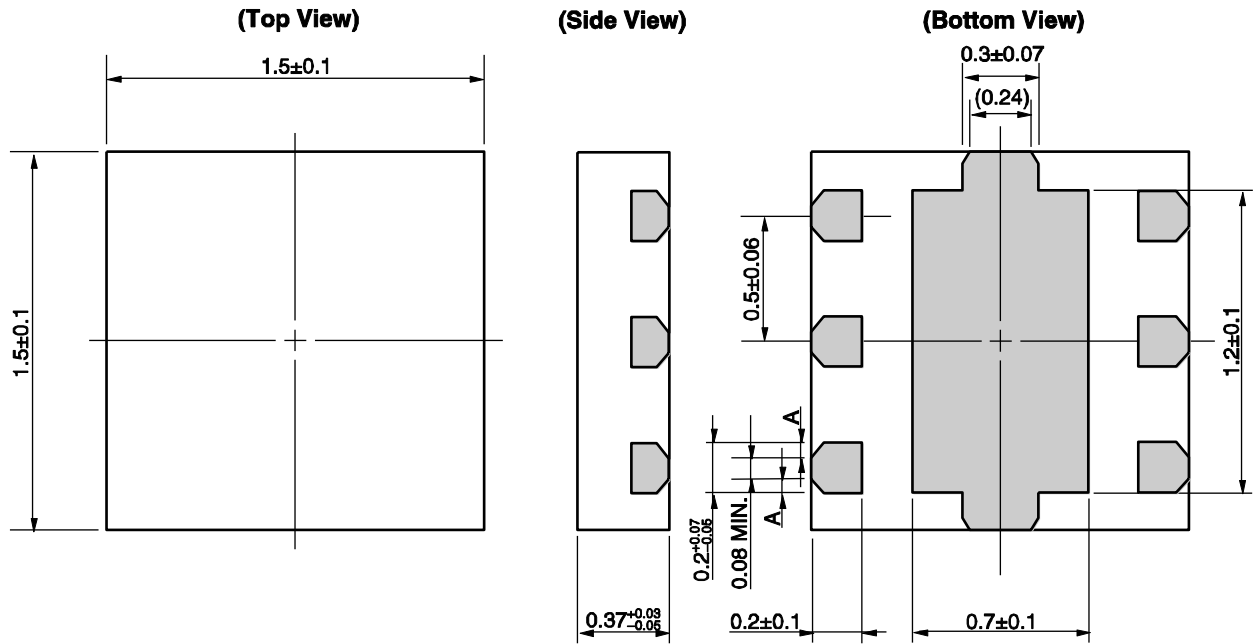

**Remark A>0**

( ) : Reference value

**NOTES ON CORRECT USE**

- (1) Observe precautions for handling because of electro-static sensitive devices.
- (2) Form a ground pattern as widely as possible to minimize ground impedance (to prevent undesired oscillation).  
All the ground terminals must be connected together with wide ground pattern to decrease impedance difference.
- (3) The bypass capacitor should be attached to Vcc line.
- (4) Do not supply DC voltage to INPUT pin.

**RECOMMENDED SOLDERING CONDITIONS**

This product should be soldered and mounted under the following recommended conditions. For soldering methods and conditions other than those recommended below, contact your nearby sales office.

Soldering Method	Soldering Conditions	Condition Symbol
Infrared Reflow	Peak temperature (package surface temperature) : 260°C or below Time at peak temperature : 10 seconds or less Time at temperature of 220°C or higher : 60 seconds or less Preheating time at 120 to 180°C : 120±30 seconds Maximum number of reflow processes : 3 times Maximum chlorine content of rosin flux (% mass) : 0.2%(Wt.) or below	IR260
Wave Soldering	Peak temperature (molten solder temperature) : 260°C or below Time at peak temperature : 10 seconds or less Preheating temperature (package surface temperature) : 120°C or below Maximum number of flow processes : 1 time Maximum chlorine content of rosin flux (% mass) : 0.2%(Wt.) or below	WS260
Partial Heating	Peak temperature (terminal temperature) : 350°C or below Soldering time (per side of device) : 3 seconds or less Maximum chlorine content of rosin flux (% mass) : 0.2%(Wt.) or below	HS350

**Caution Do not use different soldering methods together (except for partial heating).**