

Features

- High-speed access times
 - Com'l: 8, 10, 12, 15, and 20 ns
 - Ind: 12, 15, and 20 ns
- Low power operation (typical)
 - PDM31564SA
 - Active: 300 mW
 - Standby: 25mW
- High-density 256K x 16 architecture
- 3.3V ($\pm 0.3V$) power supply
- Fully static operation
- TTL-compatible inputs and outputs
- Output buffer controls: \overline{OE}
- Data byte controls: \overline{LB} , \overline{UB}
- Packages:
 - Plastic SOJ (400 mil) - SO
 - Plastic TSOP (II) - T

Description

The PDM31564 is a high-performance CMOS static RAM organized as 262,144 x 16 bits. The PDM31564 features low power dissipation using chip enable (\overline{CE}) and has an output enable input (\overline{OE}) for fast memory access. Byte access is supported by upper and lower byte controls.

The PDM31564 operates from a single 3.3V power supply and all inputs and outputs are fully TTL-compatible.

The PDM31564 is available in a 44-pin 400-mil plastic SOJ and a plastic TSOP package for high-density surface assembly and is suitable for use in high-speed applications requiring high-speed storage.

Functional Block Diagram

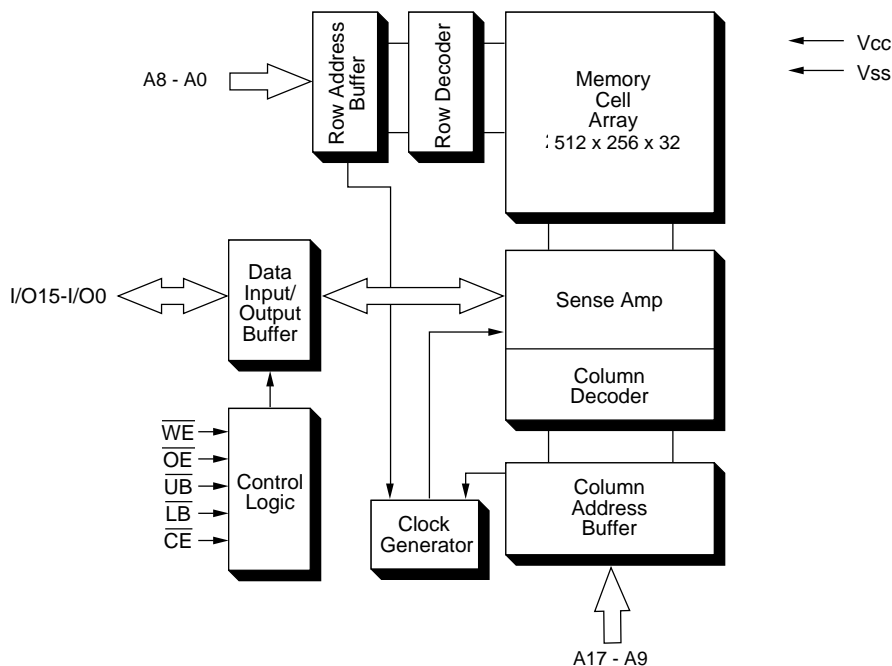

Pin Configuration

TSOP (II)

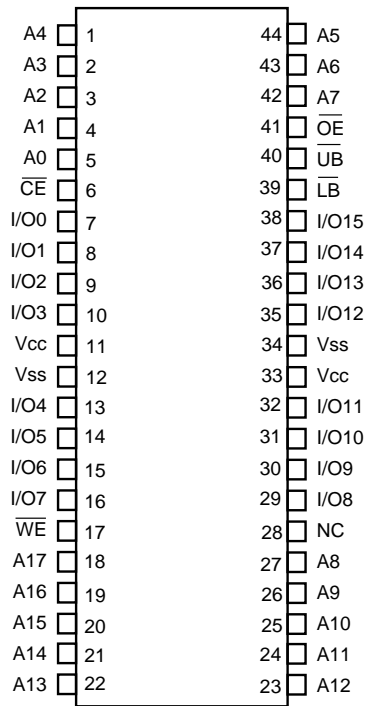

SOJ

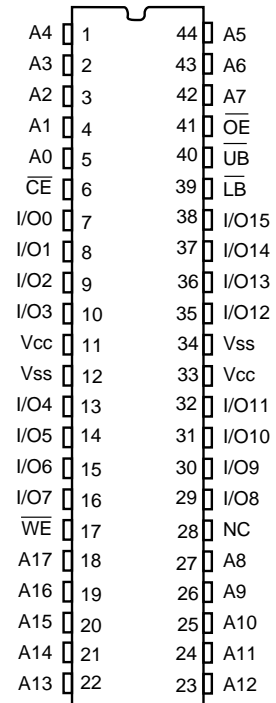

Pin Description

Name	Description
A17-A0	Address Inputs
I/O15-I/O0	Data Inputs
CE	Chip Enable Input
WE	Write Enable Input
OE	Output Enable Input
LB, UB	Data Byte Control Inputs
NC	No Connect
V _{ss}	Ground
V _{CC}	Power (+3.3V)

Capacitance (T_A = +25°C, f = 1.0 MHz)

Symbol	Parameter	Conditions	Max.	Unit
C _{IN}	Input Capacitance	V _{IN} = V _{SS}	6	pF
C _{I/O}	Output Capacitance	V _{I/O} = V _{SS}	8	pF

NOTE: This parameter is determined by device characterization, but is not production tested.

Operating Mode

Mode	CE	OE	WE	LB	UB	I/O7-I/O0	I/O15-I/O8	Power
Read	L	L	H	L	L	Output	Output	I _{CC}
				H	L	High Impedance	Output	I _{CC}
				L	H	Output	High Impedance	I _{CC}
Write	L	X	L	L	L	Input	Input	I _{CC}
				H	L	High Impedance	Input	I _{CC}
				L	H	Input	High Impedance	I _{CC}
Output Disable	L	H	H	X	x	High Impedance	High Impedance	I _{CC}
	L	X	X	H	H	High Impedance	High Impedance	I _{CC}
Standby	H	X	X	X	X	High Impedance	High Impedance	I _{SB}

NOTE: H = V_{IH}, L = V_{IL}, X = DON'T CARE

Absolute Maximum Ratings (1)

Symbol	Rating	Com'l.	Ind.	Unit
V _{TERM}	Terminal Voltage with Respect to V _{SS}	-0.5 to +4.6	-0.5 to +4.6	V
T _{BIAS}	Temperature Under Bias	-55 to +125	-65 to +135	°C
T _{STG}	Storage Temperature	-55 to +125	-65 to +150	°C
P _T	Power Dissipation	1.5	1.5	W
I _{OUT}	DC Output Current	50	50	mA
T _j	Maximum Junction Temperature (2)	125	145	°C

- NOTE: 1. Stresses greater than those listed under ABSOLUTE MAXIMUM RATINGS may cause permanent damage to the device. This is a stress rating only and functional operation of the device at these or any other conditions above those indicated in the operational sections of this specification is not implied. Exposure to absolute maximum rating conditions for extended periods may affect reliability.
2. Appropriate thermal calculations should be performed in all cases and specifically for those where the chosen package has a large thermal resistance (e.g., TSOP). The calculation should be of the form: $T_j = T_a + P * \theta_{ja}$ where T_a is the ambient temperature, P is average operating power and θ_{ja} the thermal resistance of the package. For this product, use the following θ_{ja} values:

SOJ: 59° C/W
 TSOP: 87° C/W

Recommended DC Operating Conditions

Symbol	Description	Min.	Typ.	Max.	Unit
V _{CC}	Supply Voltage	3.0	3.3	3.6	V
V _{SS}	Supply Voltage	0	0	0	V
Industrial	Ambient Temperature	-40	25	85	°C
Commercial	Ambient Temperature	0	25	70	°C

DC Electrical Characteristics ($V_{CC} = 3.3V \pm 0.3V$)

Symbol	Parameter	Test Conditions		Min.	Max.	Unit
I_{LI}	Input Leakage Current	$V_{CC} = \text{Max.}, V_{IN} = V_{SS} \text{ to } V_{CC}$	Com'l/ Ind.	-5	5	μA
I_{LO}	Output Leakage Current	$V_{CC} = \text{Max.}, \overline{CE} = V_{IH}, V_{OUT} = V_{SS} \text{ to } V_{CC}$	Com'l/ Ind.	-5	5	μA
V_{IL}	Input Low Voltage			-0.3 ⁽¹⁾	0.8	V
V_{IH}	Input High Voltage			2.2	$V_{CC} + 0.3$	V
V_{OL}	Output Low Voltage	$I_{OL} = 8 \text{ mA}, V_{CC} = \text{Min.}$		—	0.4	V
V_{OH}	Output High Voltage	$I_{OH} = -4 \text{ mA}, V_{CC} = \text{Min.}$		2.4	—	V

NOTE: 1. $V_{IL}(\text{min}) = -3.0V$ for pulse width less than 20 ns.

Power Supply Characteristics

Symbol	Parameter	-8	-10	-12		-15		-20		Unit
		Com'l	Com'l	Com'l	Ind.	Com'l	Ind.	Com'l	Ind.	
I_{CC}	Operating Current $\overline{CE} = V_{IL}$ $f = f_{MAX} = 1/t_{RC}$ $V_{CC} = \text{Max.}$ $I_{OUT} = 0 \text{ mA}$	220	210	200	210	190	200	185	195	mA
I_{SB}	Standby Current $\overline{CE} = V_{IH}$ $f = f_{MAX} = 1/t_{RC}$ $V_{CC} = \text{Max.}$	50	45	40	45	35	40	30	35	mA
I_{SB1}	Full Standby Current $\overline{CE} \geq V_{CC} - 0.2V$ $f = 0$ $V_{CC} = \text{Max.},$ $V_{IN} \geq V_{CC} - 0.2V \text{ or } \leq 0.2V$	10	10	10	15	10	15	10	15	mA

NOTES: All values are maximum guaranteed values.

AC Test Conditions

Input pulse levels	V_{SS} to 3.0V
Input rise and fall times	2.5 NS
Input timing reference levels	1.5V
Output reference levels	1.5V
Output load	See Figures 1 and 2

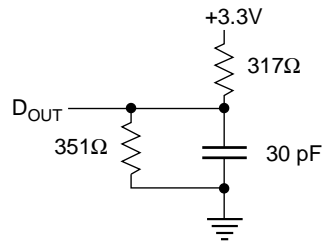

Figure 1. Output Load

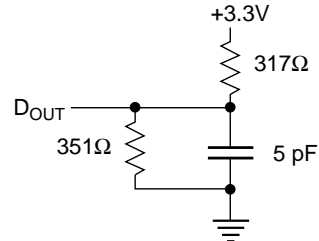
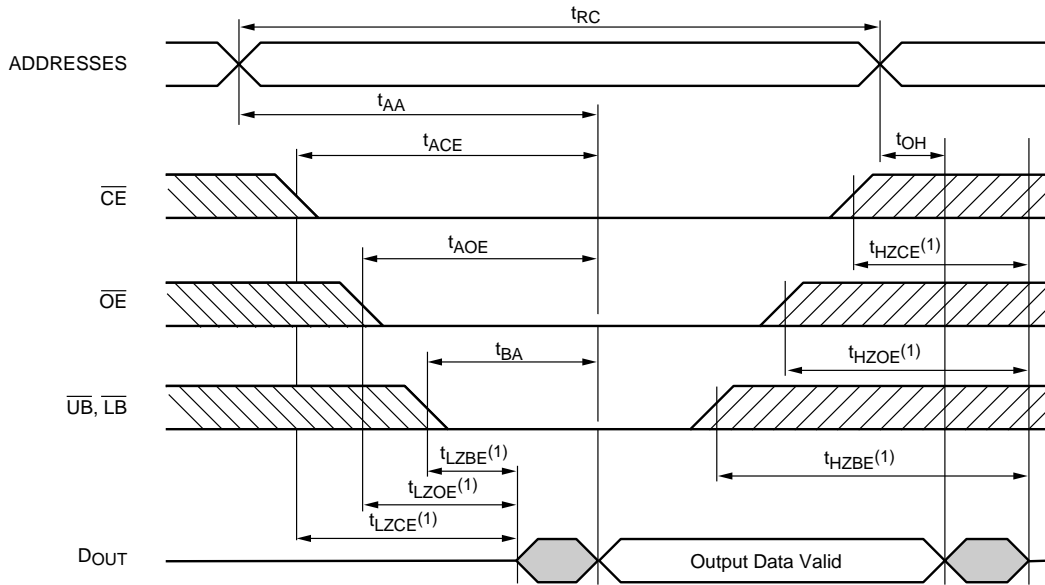

Figure 2. Output Load Equivalent
 (for t_{LZCE} , t_{HZCE} , t_{LZWE} , t_{HZWE} ,
 t_{LZBE} , t_{HZBE} , t_{LZOE} , t_{HZOE})

Read Timing Diagram



AC Electrical Characteristics

Description	Symbol	-8*		-10*		-12		-15		-20		Unit
		Min	Max	Min	Max	Min	Max	Min	Max	Min	Max	
READ cycle time	t_{RC}	8	—	10	—	12	—	15	—	20	—	ns
Address access time	t_{AA}	—	8	—	10	—	12	—	15	—	20	ns
Chip enable access time	t_{ACE}	—	8	—	10	—	12	—	15	—	20	ns
Byte access time	t_{BA}	—	5	—	6	—	7	—	8	—	9	ns
Output hold from address change	t_{OH}	4	—	4	—	4	—	4	—	4	—	ns
Byte disable to output in low-Z ⁽¹⁾	$t_{LZBE}^{(1)}$	0	—	0	—	0	—	0	—	0	—	ns
Byte enable to output in high-Z ⁽¹⁾	$t_{HZBE}^{(1)}$	—	4	—	5	—	8	—	9	—	9	ns
Chip enable to output in low-Z ⁽¹⁾	$t_{LZCE}^{(1)}$	3	—	3	—	4	—	4	—	5	—	ns
Chip disable to output high-Z ^(1, 2)	$t_{HZCE}^{(1)}$	—	4	—	5	—	6	—	7	—	8	ns
Output enable access time	t_{AOE}	—	4	—	5	—	6	—	7	—	10	ns
Output enable to output in low-Z ⁽¹⁾	$t_{LZOE}^{(1)}$	0	—	0	—	0	—	0	—	0	—	ns
Output disable to output in high-Z ^(1, 2)	$t_{HZOE}^{(1)}$	—	4	—	5	—	5	—	6	—	6	ns

* $V_{CC} = 3.3V \pm 5\%$

Write Cycle 1 Timing Diagram (\overline{WE} Controlled)

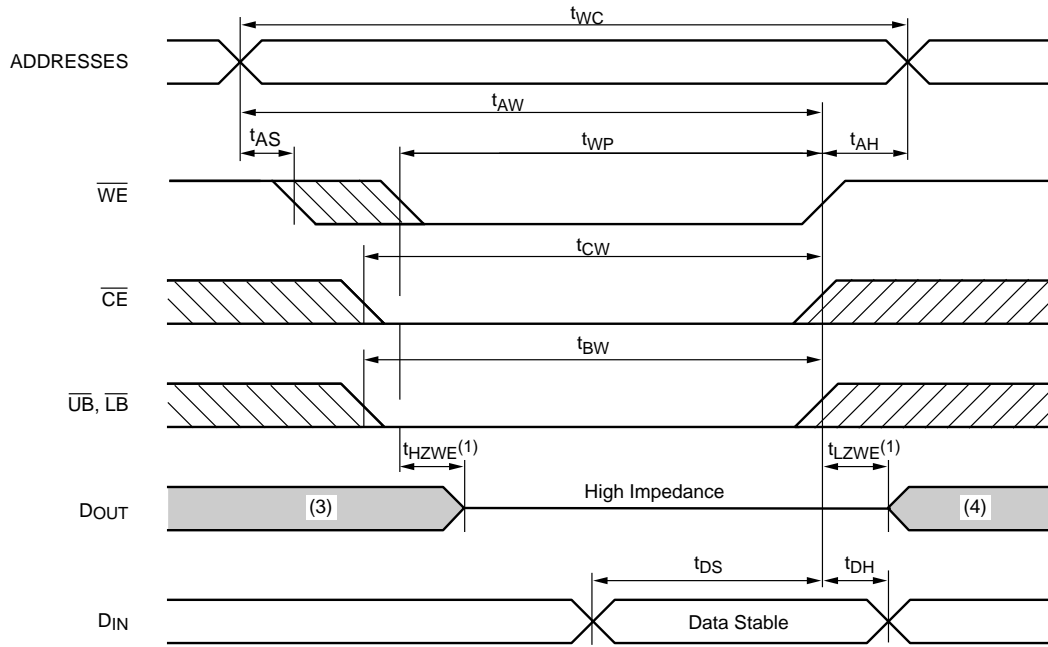

Write Cycle 2 Timing Diagram (\overline{CE} Controlled)

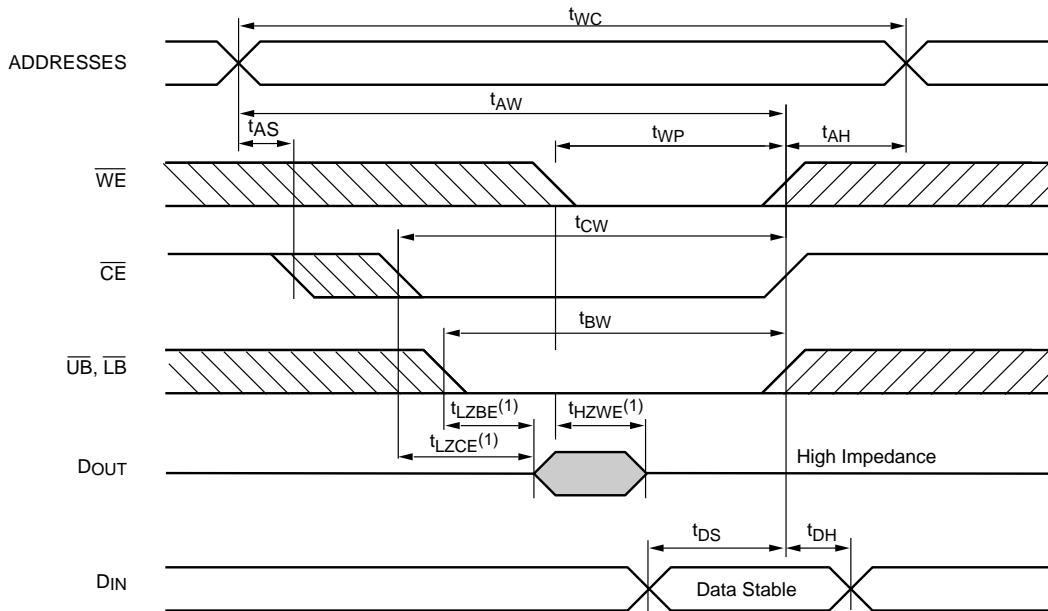

Write Cycle 3 Timing Diagram (\overline{UB} , \overline{LB} Controlled)

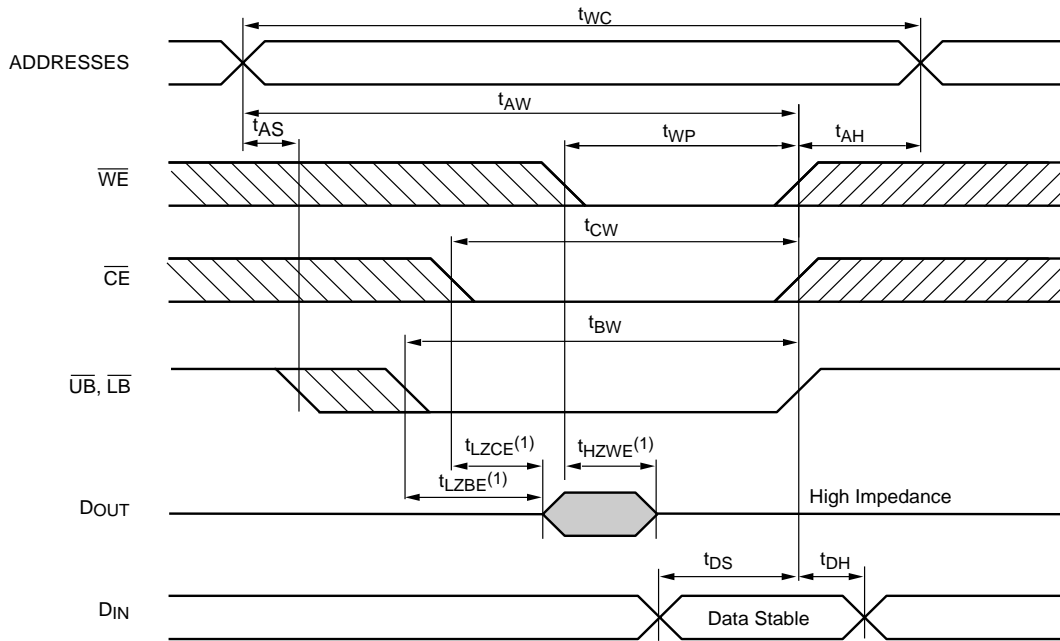

AC Electrical Characteristics

Description	Sym	-8*		-10*		-12		-15		-20		Unit
		Min.	Max	Min.	Max	Min.	Max.	Min.	Max.	Min.	Max.	
WRITE Cycle												
WRITE cycle time	t_{WC}	8	—	10	—	12	—	15	—	20	—	ns
Chip enable to end of write	t_{CW}	7	—	8	—	10	—	11	—	13	—	ns
Address valid to end of write	t_{AW}	7	—	8	—	10	—	11	—	13	—	ns
Byte pulse width	t_{BW}	7	—	8	—	10	—	12	—	13	—	ns
Address setup time	t_{AS}	0	—	0	—	0	—	0	—	0	—	ns
Address hold from end of write	t_{AH}	0	—	0	—	0	—	0	—	0	—	ns
Write pulse width	t_{WP}	7	—	8	—	8	—	9	—	10	—	ns
Data setup time	t_{DS}	5	—	6	—	7	—	8	—	9	—	ns
Data hold time	t_{DH}	0	—	0	—	0	—	0	—	0	—	ns
Byte disable to output in low $Z^{(1,3,4)}$	t_{LZBE}	0	—	0	—	0	—	0	—	0	—	ns
Byte enable to output in high $Z^{(1,3,4)}$	t_{HZBE}	—	6	—	6	—	7	—	8	—	9	ns
Output disable to output in low $Z^{(1,3,4)}$	t_{LZOE}	0	—	0	—	0	—	0	—	0	—	ns
Output enable to output in high $Z^{(1,3,4)}$	t_{HZOE}	—	6	—	6	—	7	—	7	—	8	ns
Write disable to output in low $Z^{(1,3,4)}$	t_{LZWE}	0	—	0	—	0	—	0	—	0	—	ns
Write enable to output in high $Z^{(1,3,4)}$	t_{HZWE}	—	6	6	—	—	7	—	7	—	9	ns

* $V_{CC} = 3.3v \pm 5\%$

NOTES:

1. Parameter is determined by device characterization and is not production tested. See Figure 2 for load conditions.
2. If the \overline{CE} LOW transition occurs coincident with or after the \overline{WE} LOW transition, outputs remain in a high impedance state.
3. If the \overline{CE} HIGH transition occurs coincident with or after the \overline{WE} HIGH transition, outputs remain in a high impedance state.
4. If \overline{OE} is HIGH during a write cycle, the outputs are in a high-impedance state during this period.

Ordering Information

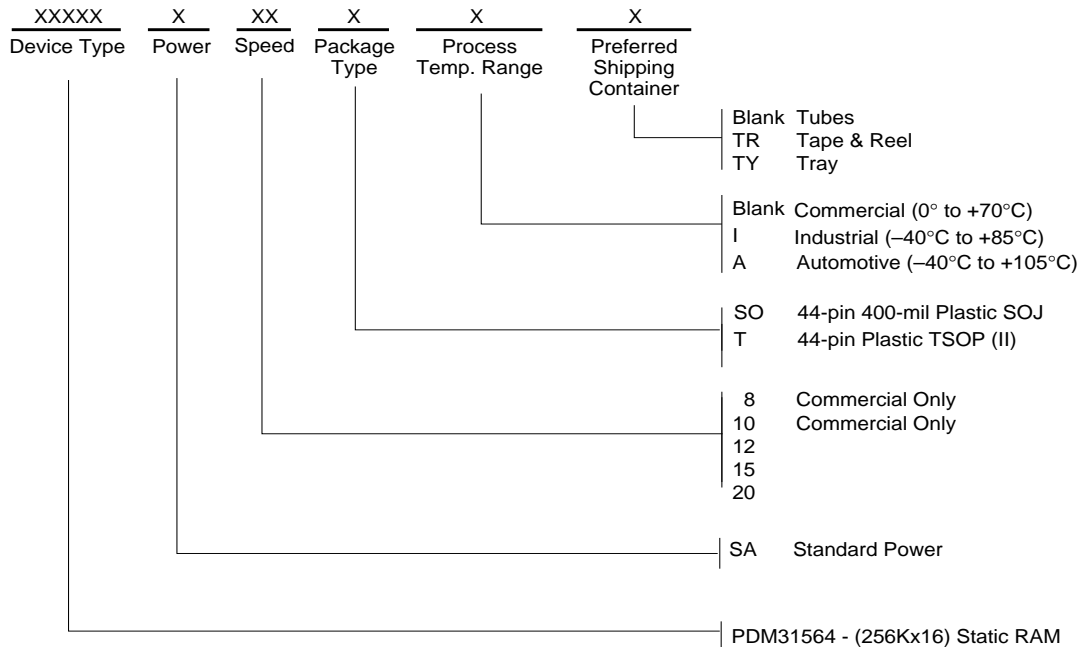

Faster Memories for a Faster World™