

### FEATURES

- Dual functionality: piezoelectric actuator & sensor
- Robust Polyimide Packaging
- Quick Connect/Disconnect Connector
- Hermetically Sealed for Use in Harsh Environments
- Low Profile & highly flexible
- Available in Different Sizes to Suit Application
- Extra-Flexible Packs available for application to curved surfaces (pipes, etc.)

### APPLICATIONS

- Vibration & strain sensing
- Passive vibration/strain detection
- Precise actuation
- Electronics cooling

### DESCRIPTION

Midé's QuickPack product line takes advantage of a patented packaging process that allows the normally brittle piezoelectric ceramic to be encapsulated in protective polyimide layers. These protective layers drastically increases the actuator's robustness, and usefulness in real world applications.

The packaging process electrically isolates the piezoelectric ceramic, and allows the device to be used in otherwise adverse environmental conditions including submerged applications.

In addition to the standard QuickPack Products, Midé offers custom piezoelectric device design solutions. If a custom size is required please contact Midé Technology Corporation by emailing: [products\\_quickpack\\_08@midé.com](mailto:products_quickpack_08@midé.com)

### TYPICAL APPLICATIONS

#### SIMPLE SENSOR

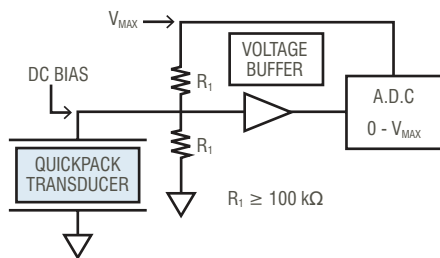

#### ADVANCED SENSOR

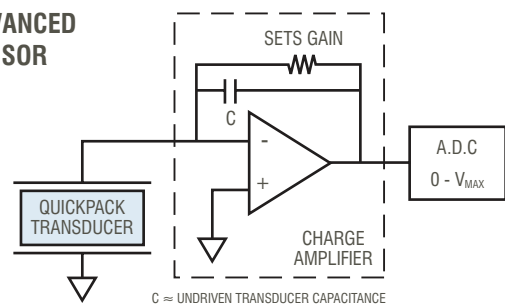

#### ACTUATOR

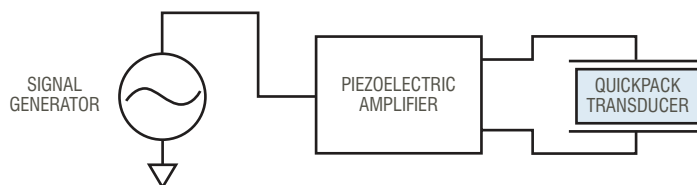

**PRODUCT DIMENSIONS**

**NOTE:**

- 1. All dimensions are in inches
- 2. Connector thickness = 0.100"

Product	Thick. (in)	Cap. (nF)*
QP10N	0.015	55
QP10W	0.015	85
QP10Ni	0.015	1.2
QP16N	0.010	125
PA16N	0.013	95
QP20N	0.030	100
QP20W	0.030	145
QP21B	0.030	125
QP22B	0.030	20
P. FAN	0.030	23

\*Capacitance values are approximate and will vary from product to product.

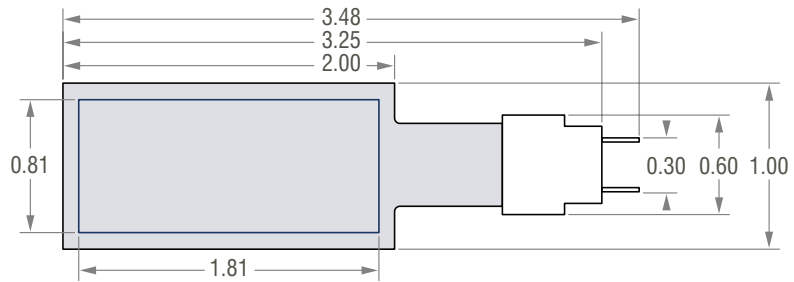

**QP10N  
QP16N**

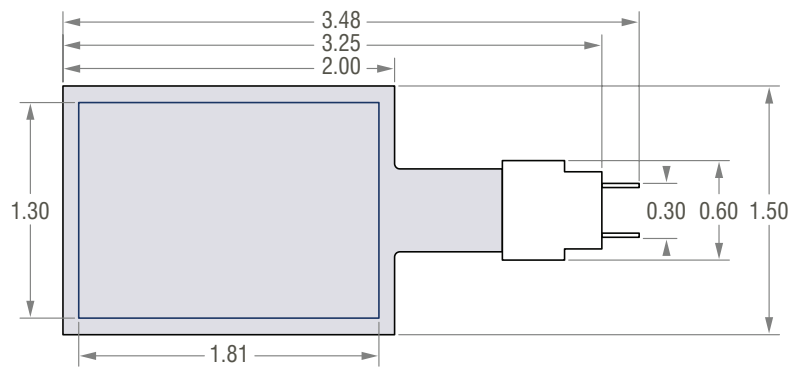

**QP10W**

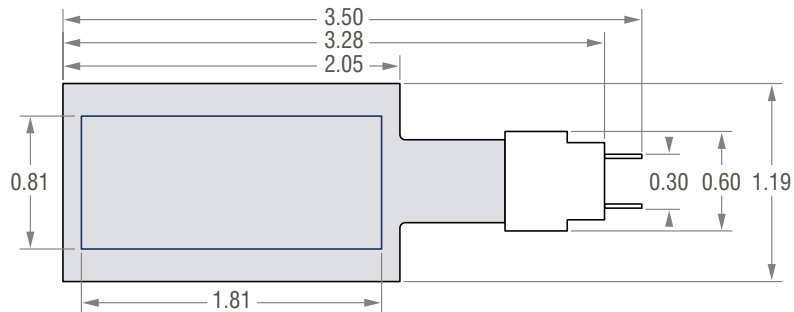

**QP10Ni  
PA16N**

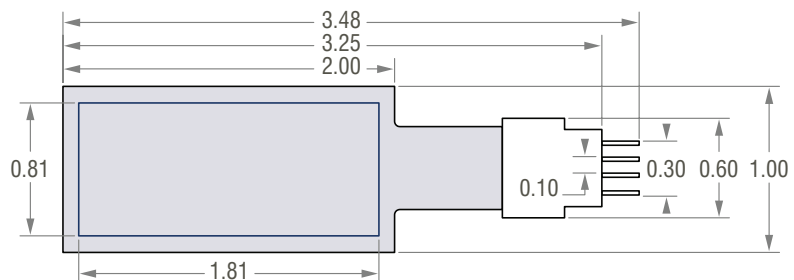

**QP20N**

PRODUCT DIMENSIONS

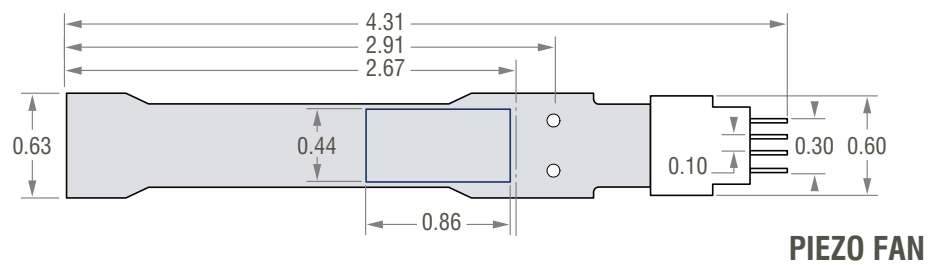
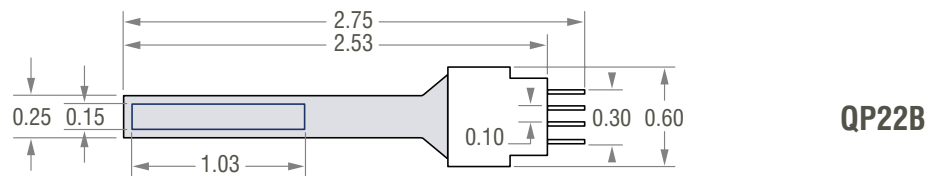
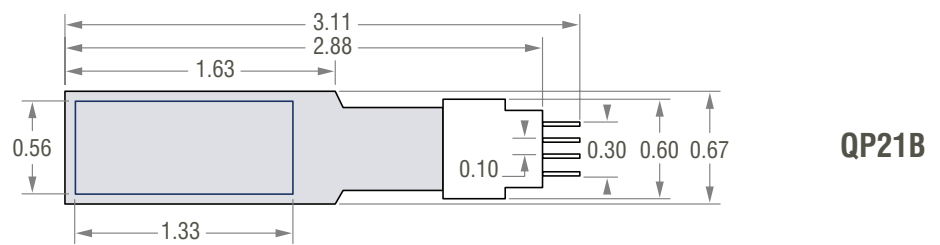
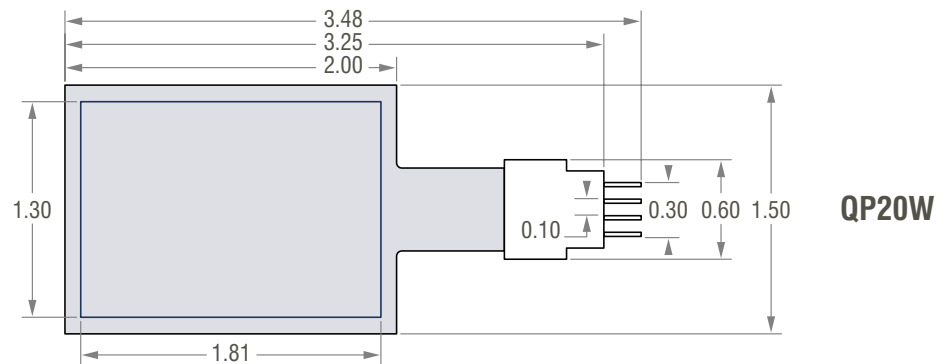

FUNCTIONAL DIAGRAMS & COMPATIBLE CABLES

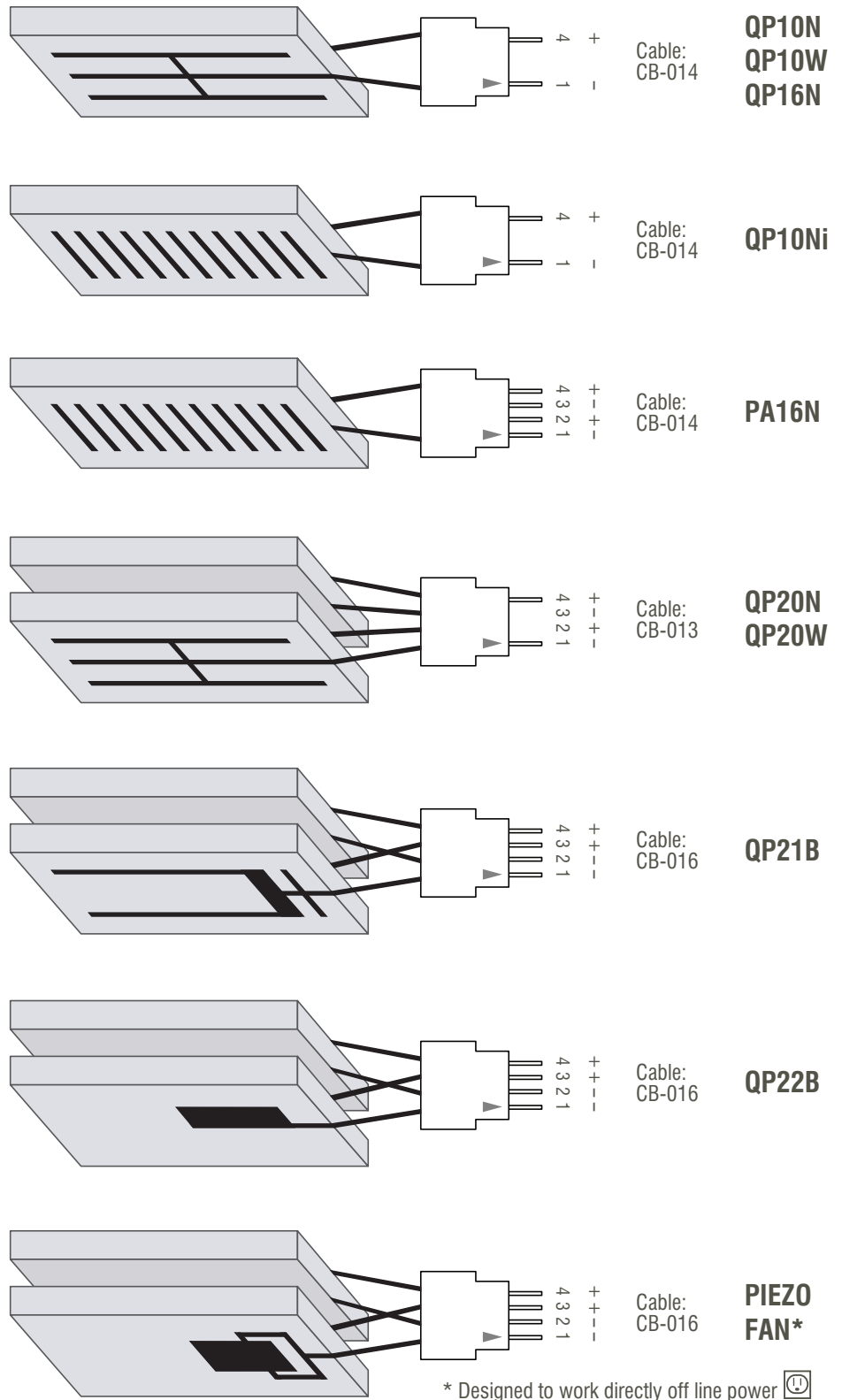

---

## ABSOLUTE MAXIMUM RATINGS

Operating Temperature Range	-40 to 90 C
Operating Temperature Range (Without Connector)	-40 to 150 C
Storage Temperature Range	-60 to 90 C
Storage Temperature Range (Without Connector)	-60 to 150 C
Lead Temperatures (Soldering, 10 sec)	300 C
Piezo Strain, max	800 micro-strain

---

## OPERATION

Piezoelectric ceramic is capable of providing a very precise signal in response to very small amounts of imposed strain. The same effect is true in reverse; a finely controlled input signal can produce an efficient response in the material when the device is used as an actuator.

Midé's QuickPack transducers are designed to provide precise and repeatable actuation or strain induced measurement in challenging operating environments. Midé's QuickPack transducers are suited for use in harsh environments commonly found in industrial applications. The QuickPack transducer is not, however, ideally suited to a specific application. Instead, Midé has developed a range of QuickPack products intended to provide a good starting point for your actuation or sensing needs. In order to maximize the cost effectiveness of implementing piezoelectric technology into your application, it may be necessary to investigate a custom design suited to your specific application. The standard QuickPack designs have been tailored to provide a sample of the many possibilities that exist when using piezoelectric transducers

Most QuickPack Transducers operate on the indirect piezoelectric 3-1 effect. The piezoceramic used in these packs is poled through the thickness, and expands and contracts in plane, perpendicular to the applied field. Through the use of a specially designed inter-digitized circuit, the QP10ni is able to take advantage of the stronger direct piezoelectric 3-3 effect. Instead of being polarized through the thickness, the piezoceramic is polarized along the length. This method causes the beam to behave like a stack instead of a bender. This causes the device to be much more sensitive to strain in the longitudinal direction than in the transverse direction.

A critical aspect to consider when using any type of strain dependent device is the bond layer thickness between the device and the surface where the transducer is installed. To maximize the transducer's capability to experience the equivalent strain as the surface it is mounted to, the bond layer thickness must be minimized. Midé offers a special epoxy which is capable of adhering QuickPack transducers to a variety of surfaces while ensuring an extremely thin bond layer.

## OPERATION CONTINUED

Midé's QuickPack Piezoelectric Transducers can be used in a number of configurations depending on the intended application. Two of the most commonly used configurations for QuickPack Transducers are the bonded configuration and the cantilever configuration. The difference between these two types of configurations and examples of when this configuration would be appropriate are detailed below:

### Bonded Configuration:

A QuickPack Transducer can be mounted directly to a surface. Such a configuration is referred to as a bonded configuration. A bonded QuickPack Transducer can be applied to a flat surface, a surface with non-uniform flatness, and even some curved surfaces. Single layer QuickPack Transducers are best suited for this type of operation.

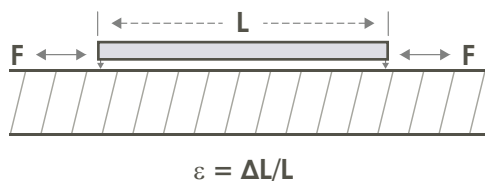

The bonded configuration is an excellent choice for sensing or creating vibrations in a relatively stiff structure. Transducers in this configuration can be used to monitor vibrations caused by an outside source, or by vibrations created in the structure by another QuickPack Transducer operating as an actuator.

### Cantilever Configuration:

A QuickPack Transducer can be mounted with only part of the package secured in a clamp, and some part of the piezoelectric element suspended outside of the clamp. This configuration is referred to as a cantilever configuration. To use a QuickPack Transducer as a cantilevered transducer, the clamp can be positioned anywhere on the pack as long as the piezoceramic element is partially clamped. However, to obtain the best response, as little of the piezoelectric element should be clamped as possible. Midé prescribes a clamp line of 0.200" from the edge of the piezoelectric element to provide enough area to properly clamp one end of the piezoceramic. Bimorph QuickPack Transducers are best suited for cantilever operation because having the active element (piezoceramic) oriented some distance away from the neutral axis allows the transducer to achieve much greater tip displacement than a single layer transducer would.

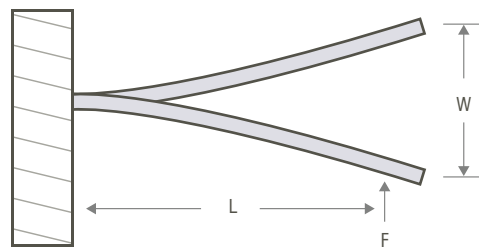

The cantilever configuration is typically employed when using a QuickPack Transducer as an actuator, although it could also be effective in using a QuickPack Transducer to sense low frequency vibrations or fluid or gaseous flow. Relatively high displacements are possible using this configuration. A prime example of a QuickPack Transducer used in a cantilever configuration is the Piezoelectric Fan.

**QP10N TYPICAL PERFORMANCE POWER CHARACTERISTICS**

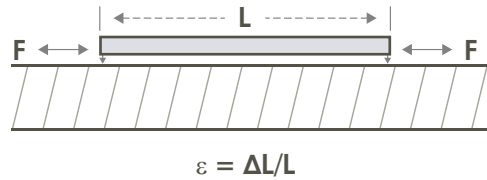
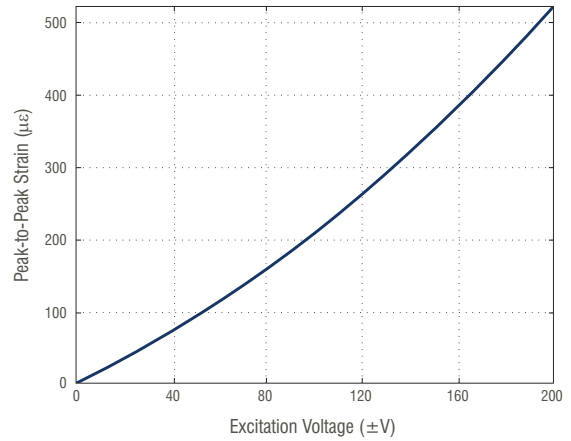
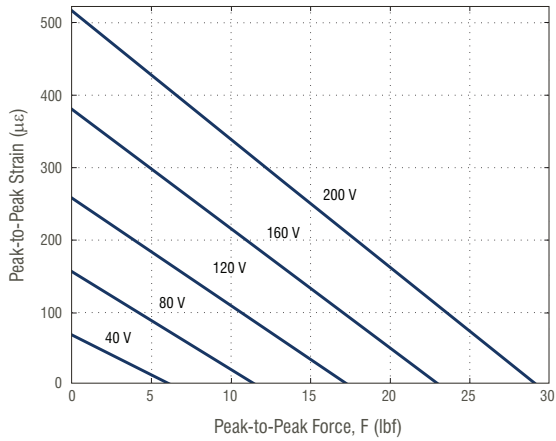

**QP10W TYPICAL PERFORMANCE POWER CHARACTERISTICS**

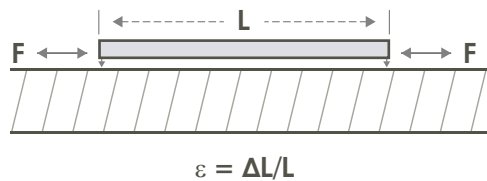
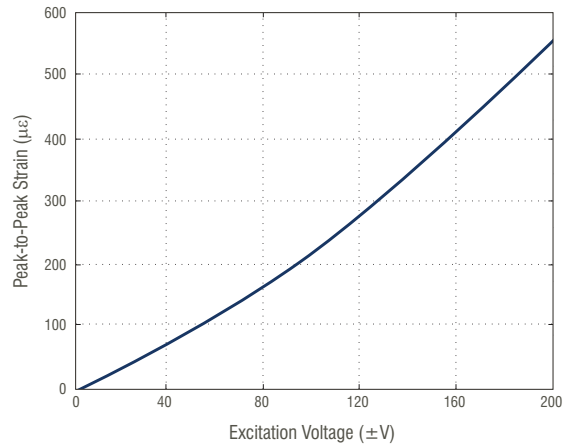
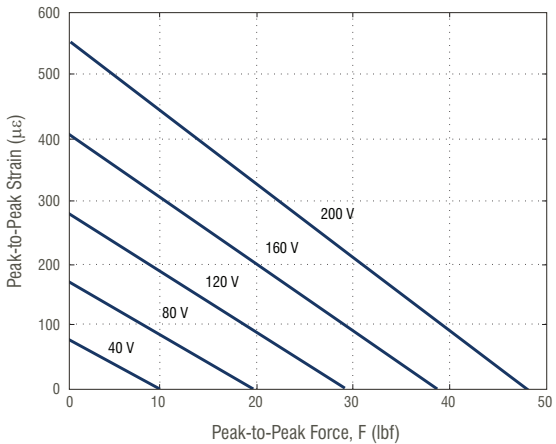

## QP10Ni TYPICAL PERFORMANCE POWER CHARACTERISTICS

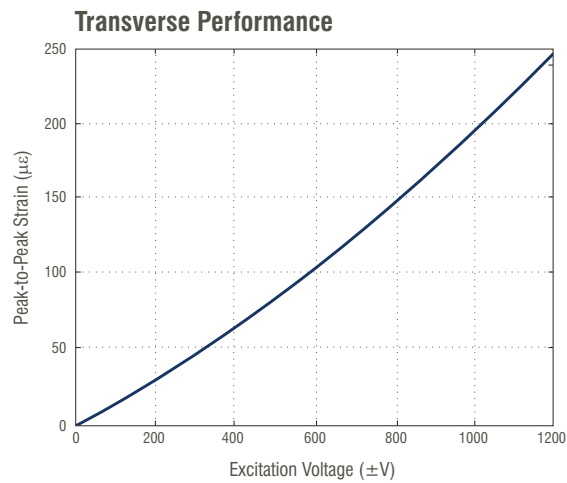
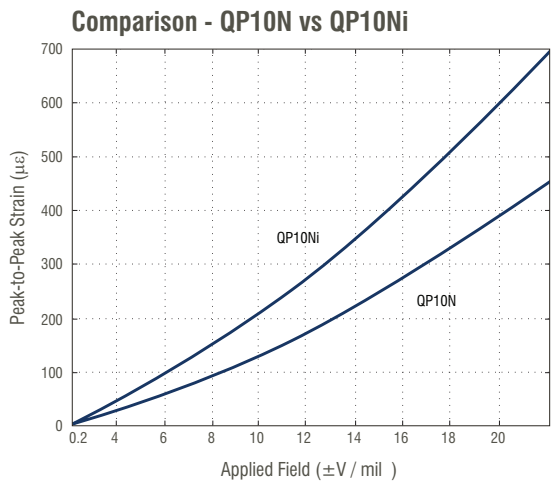
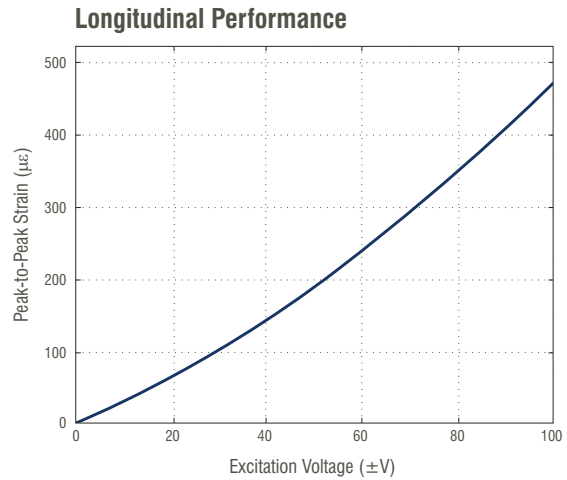
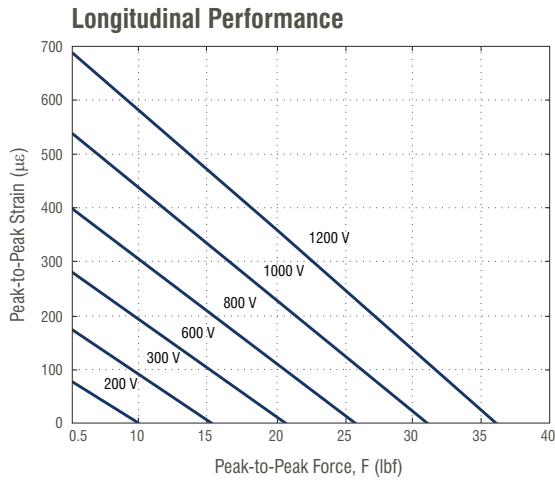

Note: The QuickPack IDE has different properties in the longitudinal and transverse directions. In the longitudinal direction, the actuator takes advantage of the d33 effect, while transverse direction is excited by the less efficient d31 effect. Strains in the longitudinal and transverse directions are out of phase with each other, i.e., when the length increases, the width decreases, and vice versa. Because it is directional, the QuickPack IDE actuator must be oriented properly in order to achieve desired performance.

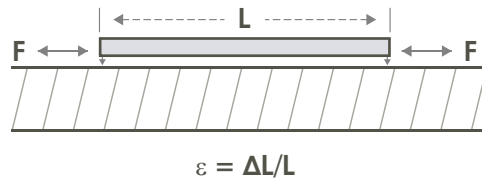



## QP16N TYPICAL PERFORMANCE POWER CHARACTERISTICS

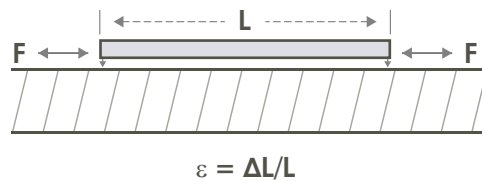
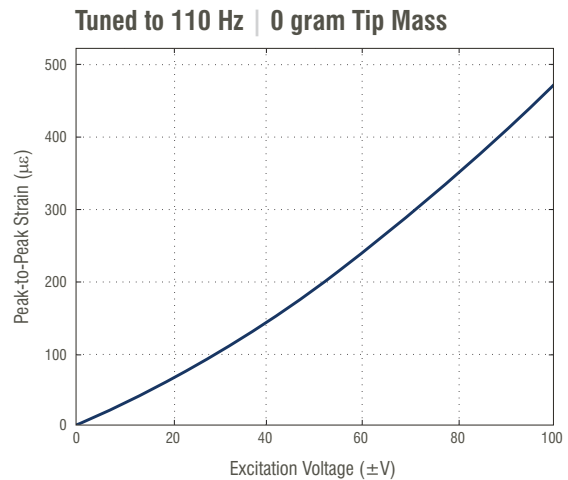
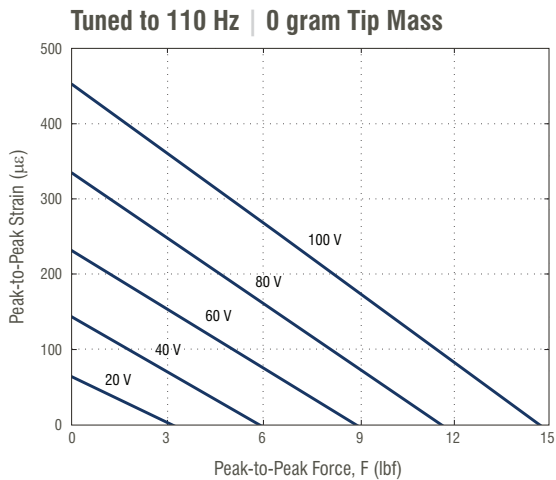

## PA16N TYPICAL PERFORMANCE POWER CHARACTERISTICS

NOTE: PowerAct enables directional, conformable actuation. The PowerAct takes advantage of a unique process to improve the flexibility of the otherwise inflexible piezoceramic. In addition, an interdigital electrode geometry enhances electromechanical coupling via the primary or direct piezoelectric effect resulting in greater performance and directional behavior.

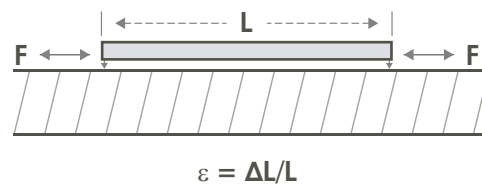
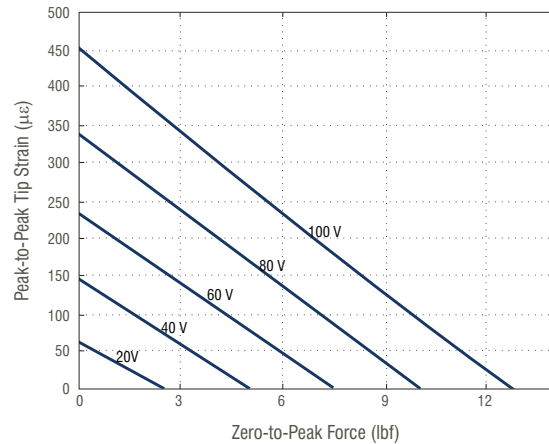

## QP20N TYPICAL PERFORMANCE POWER CHARACTERISTICS

### BONDED CONFIGURATION

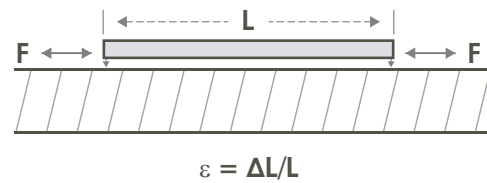
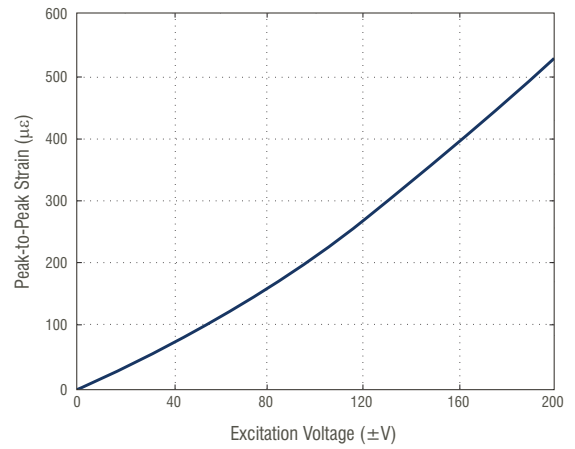
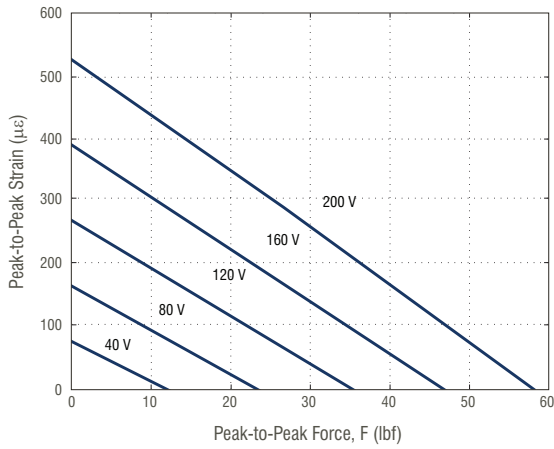

### CANTILEVER CONFIGURATION

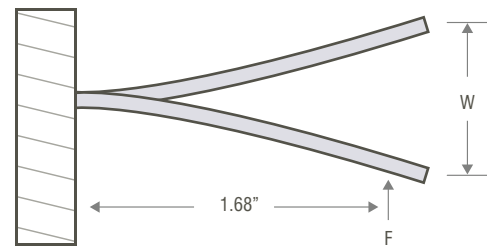
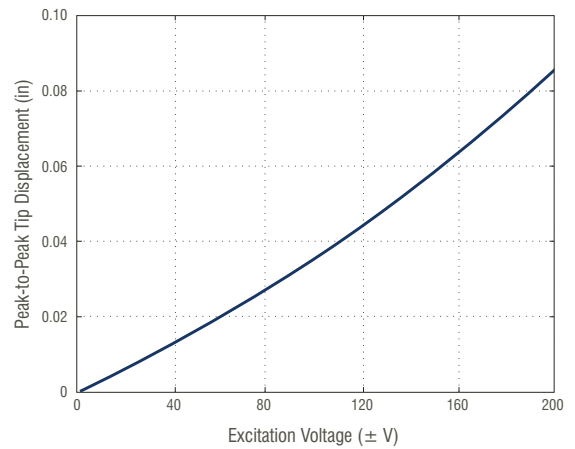
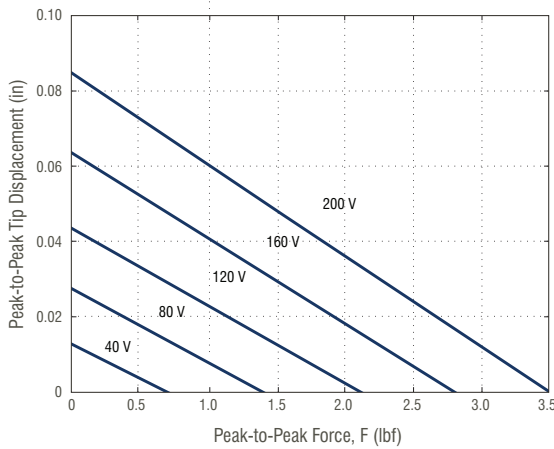

## QP20W TYPICAL PERFORMANCE POWER CHARACTERISTICS

### BONDED CONFIGURATION

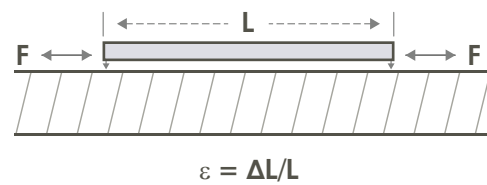
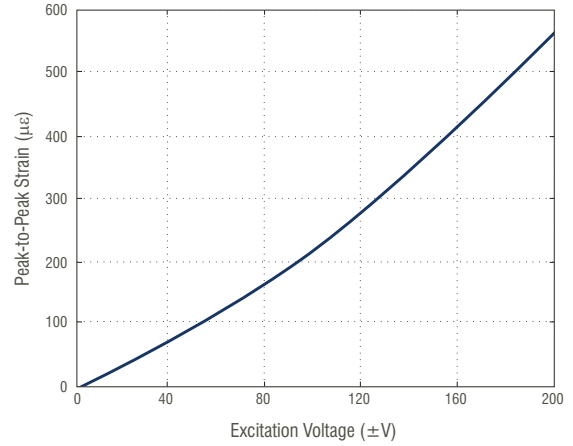
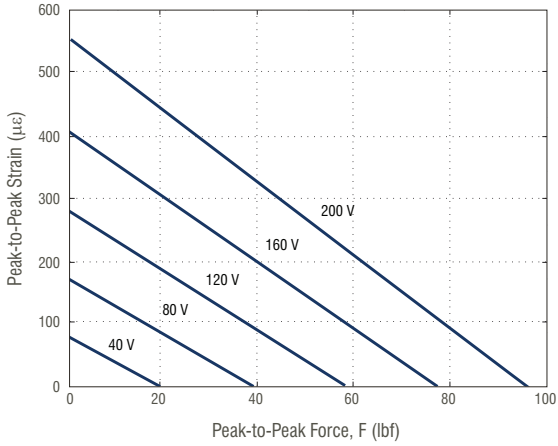

### CANTILEVER CONFIGURATION

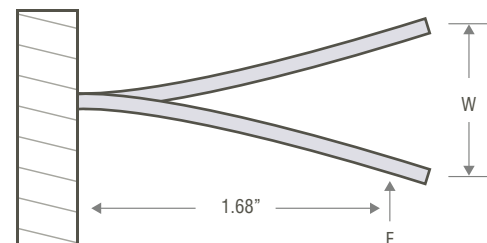
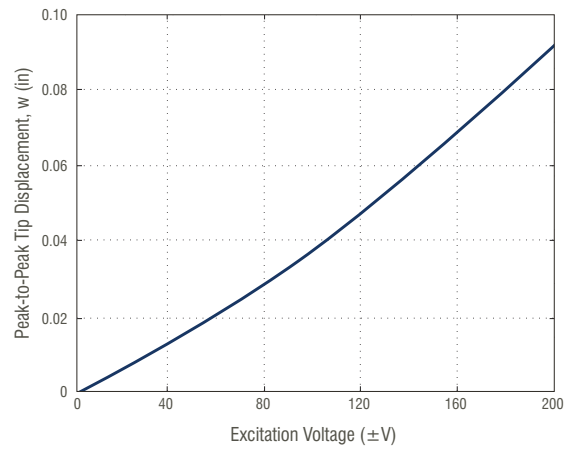
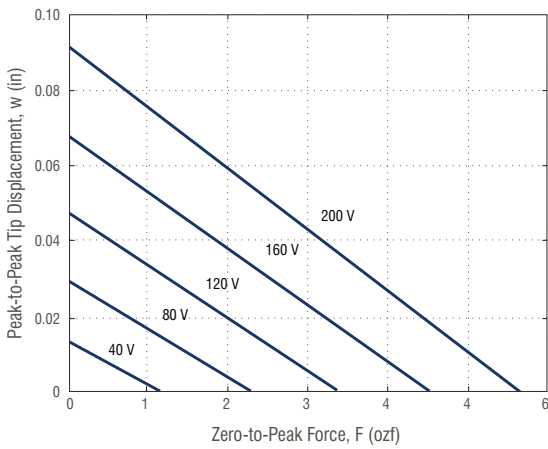

## QP21B TYPICAL PERFORMANCE POWER CHARACTERISTICS

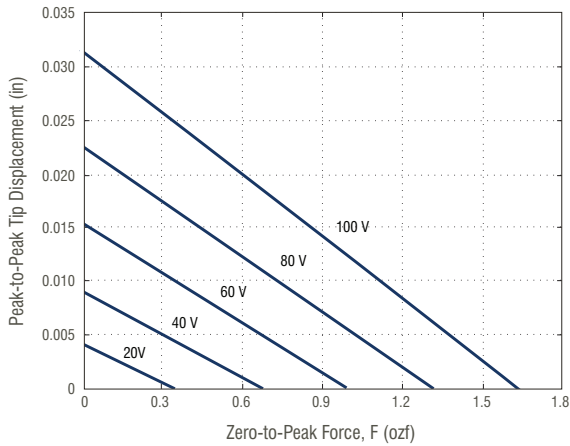

Frequency Response at ± 100 Volts

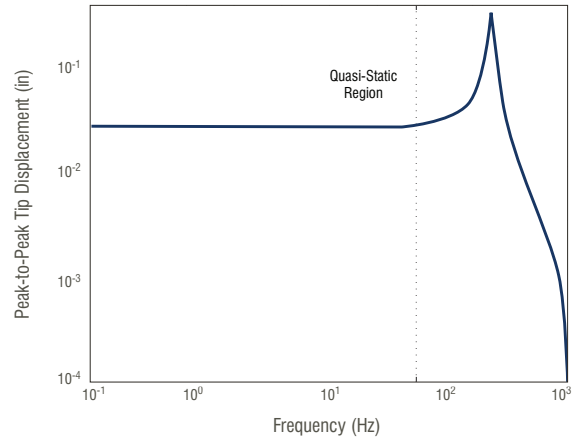

Product	L (in)
QP21B	1.00
QP22B	0.75

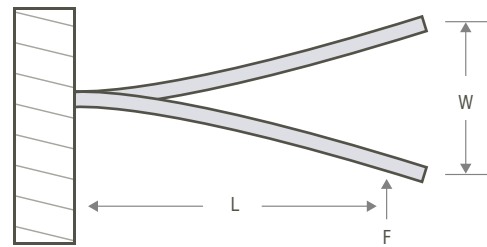

## QP22B TYPICAL PERFORMANCE POWER CHARACTERISTICS

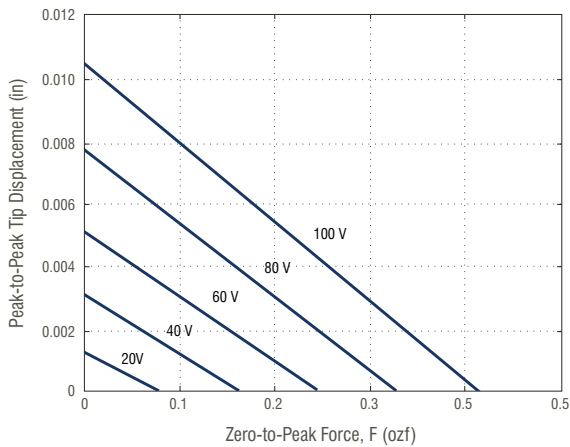

Frequency Response at +/- 100 Volts

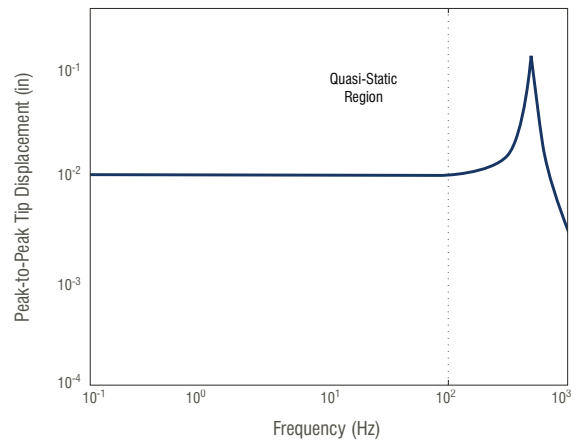

## PIEZO FAN TYPICAL PERFORMANCE POWER CHARACTERISTICS

Drive Conditions	W(in)
120V / 60Hz	1.0
220V / 50Hz	1.5

