

OptiMOS^â Buck converter series

Feature

- N-Channel
- Logic Level
- Low On-Resistance $R_{DS(on)}$
- Excellent Gate Charge x $R_{DS(on)}$ product (FOM)
- Superior thermal resistance
- 175°C operating temperature
- Avalanche rated
- dv/dt rated
- Ideal for fast switching buck converters

Product Summary

V_{DS}	30	V
$R_{DS(on)}$	20	m Ω
I_D	30	A

P- TO251 -3-1

P- TO252 -3-11

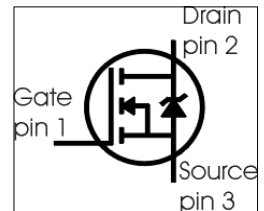
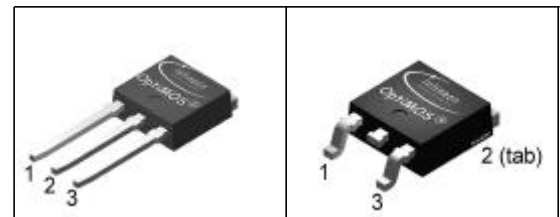

Type	Package	Ordering Code	Marking
IPD20N03L	P- TO252 -3-11	Q67042-S4050	20N03L
IPU20N03L	P- TO251 -3-1	Q67042-S4106	20N03L

Maximum Ratings, at $T_j = 25^\circ\text{C}$, unless otherwise specified

Parameter	Symbol	Value	Unit
Continuous drain current ¹⁾ $T_C=25^\circ\text{C}$	I_D	30 30	A
Pulsed drain current $T_C=25^\circ\text{C}$	$I_{D \text{ puls}}$	120	
Avalanche energy, single pulse $I_D=15\text{A}$, $V_{DD}=25\text{V}$, $R_{GS}=25\Omega$	E_{AS}	15	mJ
Repetitive avalanche energy, limited by $T_{jmax}^{2)}$	E_{AR}	6	
Reverse diode dv/dt $I_S=30\text{A}$, $V_{DS}=24\text{V}$, $di/dt=200\text{A}/\mu\text{s}$, $T_{jmax}=175^\circ\text{C}$	dv/dt	6	kV/ μs
Gate source voltage	V_{GS}	± 20	V
Power dissipation $T_C=25^\circ\text{C}$	P_{tot}	60	W
Operating and storage temperature	T_j, T_{stg}	-55... +175	$^\circ\text{C}$
IEC climatic category; DIN IEC 68-1		55/175/56	

Thermal Characteristics

Parameter	Symbol	Values			Unit
		min.	typ.	max.	
Characteristics					
Thermal resistance, junction - case	R_{thJC}	-	1.7	2.5	K/W
Thermal resistance, junction - ambient, leaded	R_{thJA}	-	-	100	
SMD version, device on PCB: @ min. footprint @ 6 cm ² cooling area ³⁾	R_{thJA}	-	-	75 50	

Electrical Characteristics, at $T_j = 25\text{ }^\circ\text{C}$, unless otherwise specified

Parameter	Symbol	Values			Unit
		min.	typ.	max.	
Static Characteristics					
Drain-source breakdown voltage $V_{GS}=0V, I_D=1mA$	$V_{(BR)DSS}$	30	-	-	V
Gate threshold voltage, $V_{GS} = V_{DS}$ $I_D=25\mu A$	$V_{GS(th)}$	1.2	1.6	2	
Zero gate voltage drain current $V_{DS}=30V, V_{GS}=0V, T_f=25^\circ C$ $V_{DS}=30V, V_{GS}=0V, T_f=125^\circ C$	I_{DSS}	-	0.01 10	1 100	μA
Gate-source leakage current $V_{GS}=20V, V_{DS}=0V$	I_{GSS}	-	1	100	
Drain-source on-state resistance $V_{GS}=4.5V, I_D=15A$	$R_{DS(on)}$	-	22.9	31	m Ω
Drain-source on-state resistance $V_{GS}=10V, I_D=15A$	$R_{DS(on)}$	-	15.5	20	

¹Current limited by bondwire ; with an $R_{thJC} = 2.5K/W$ the chip is able to carry $I_D= 42A$ at $25^\circ C$, for detailed information see app.-note ANPS071E available at www.infineon.com/optimos

²Defined by design. Not subject to production test.

³Device on 40mm*40mm*1.5mm epoxy PCB FR4 with 6cm² (one layer, 70 μm thick) copper area for drain connection. PCB is vertical without blown air.

Electrical Characteristics

Parameter	Symbol	Conditions	Values			Unit
			min.	typ.	max.	

Dynamic Characteristics

Transconductance	g_{fs}	$V_{DS} \geq 2 \cdot I_D \cdot R_{DS(on)max}$, $I_D = 30A$	14	28	-	S
Input capacitance	C_{iss}	$V_{GS} = 0V$, $V_{DS} = 25V$, $f = 1MHz$	-	530	700	pF
Output capacitance	C_{oss}		-	200	275	
Reverse transfer capacitance	C_{rss}		-	60	90	
Gate resistance	R_G		-	1.3	-	Ω
Turn-on delay time	$t_{d(on)}$	$V_{DD} = 15V$, $V_{GS} = 10V$, $I_D = 15A$, $R_G = 12.7\Omega$	-	6.2	9.3	ns
Rise time	t_r		-	11	17	
Turn-off delay time	$t_{d(off)}$		-	23	34	
Fall time	t_f		-	18	27	

Gate Charge Characteristics

Gate to source charge	Q_{gs}	$V_{DD} = 15V$, $I_D = 15A$	-	2.5	3.1	nC
Gate to drain charge	Q_{gd}		-	6.4	9.6	
Gate charge total	Q_g	$V_{DD} = 15V$, $I_D = 15A$, $V_{GS} = 0$ to $5V$	-	8.4	11	
Output charge	Q_{oss}	$V_{DS} = 15V$, $I_D = 15A$, $V_{GS} = 0V$	-	8	10	nC
Gate plateau voltage	$V_{(plateau)}$	$V_{DD} = 15V$, $I_D = 15A$	-	3.6	-	V

Reverse Diode

Inverse diode continuous forward current	I_S	$T_C = 25^\circ C$	-	-	30	A
Inv. diode direct current, pulsed	I_{SM}		-	-	120	
Inverse diode forward voltage	V_{SD}	$V_{GS} = 0V$, $I_F = 30A$	-	1.1	1.4	V
Reverse recovery time	t_{rr}	$V_R = 15V$, $I_F = I_S$, $dI_F/dt = 100A/\mu s$	-	15	18	ns
Reverse recovery charge	Q_{rr}		-	2	3	nC

1 Power dissipation

$P_{tot} = f(T_C)$

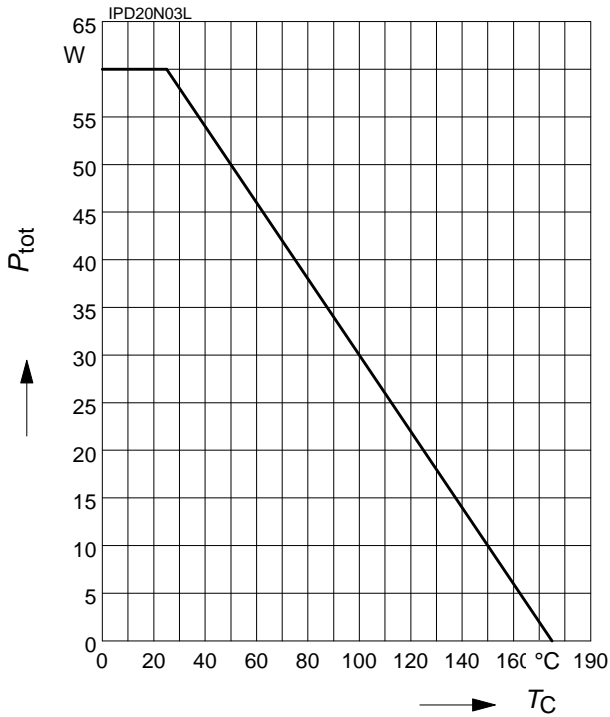

2 Drain current

$I_D = f(T_C)$

parameter: $V_{GS} \geq 10\text{ V}$

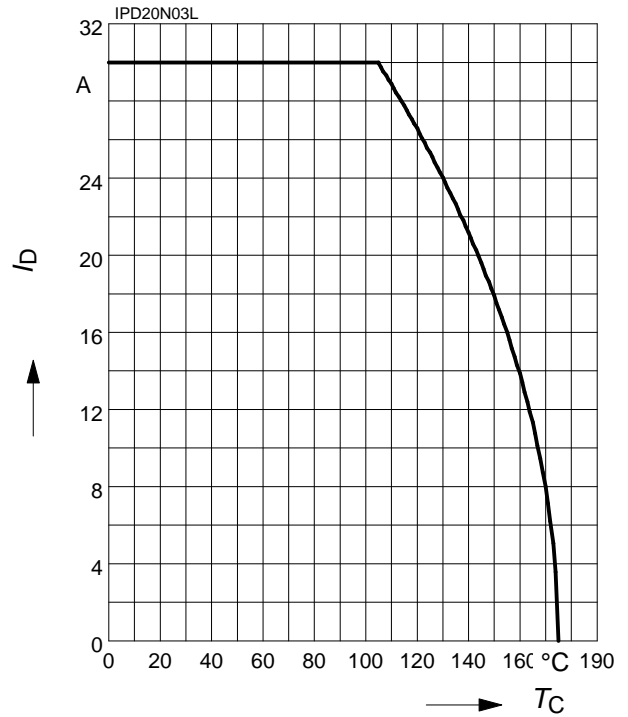

3 Safe operating area

$I_D = f(V_{DS})$

parameter: $D = 0, T_C = 25\text{ °C}$

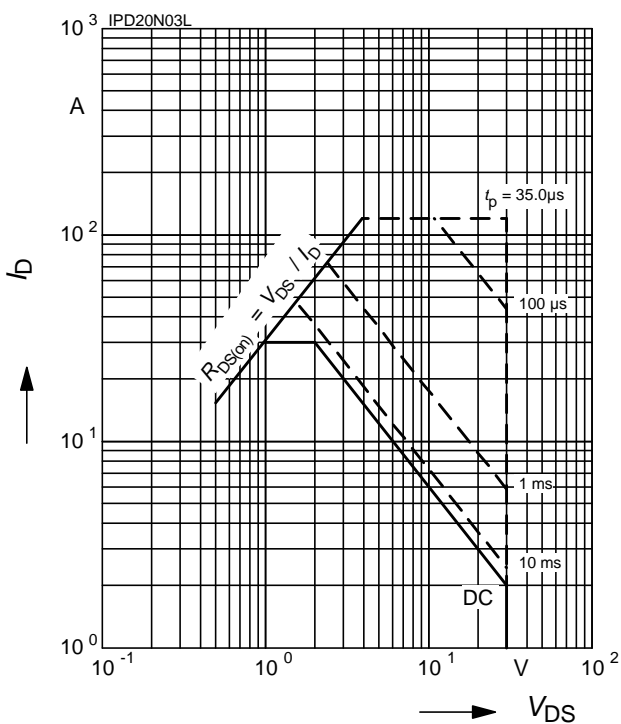

4 Max. transient thermal impedance

$Z_{thJC} = f(t_p)$

parameter: $D = t_p/T$

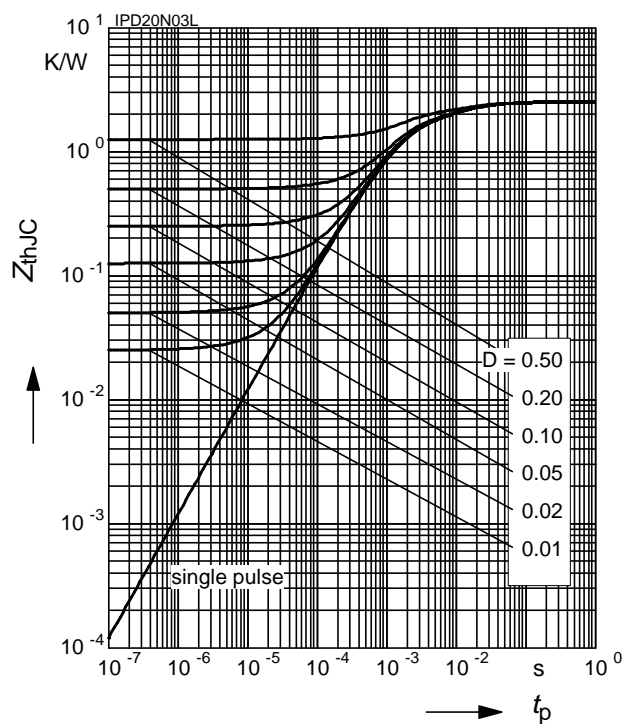

5 Typ. output characteristic

$I_D = f(V_{DS}); T_j = 25^\circ\text{C}$
parameter: $t_p = 80 \mu\text{s}$

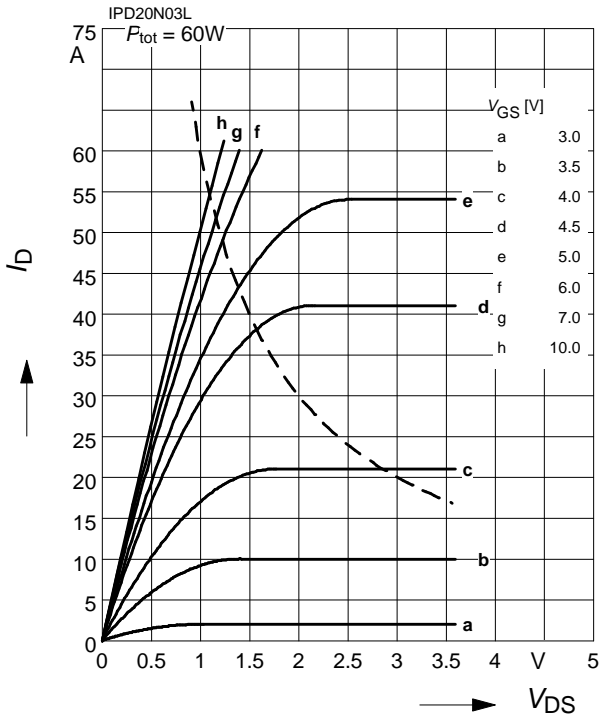

6 Typ. drain-source on resistance

$R_{DS(on)} = f(I_D)$
parameter: V_{GS}

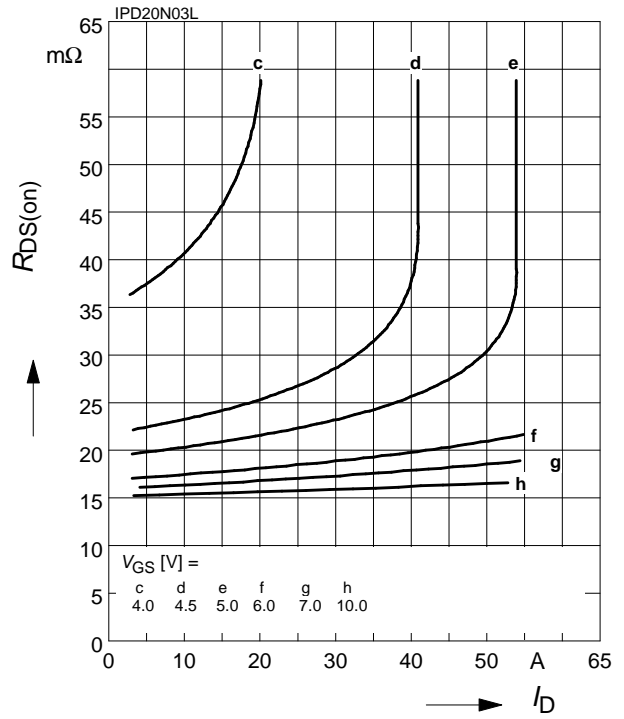

7 Typ. transfer characteristics

$I_D = f(V_{GS}); V_{DS} \geq 2 \times I_D \times R_{DS(on)max}$
parameter: $t_p = 80 \mu\text{s}$

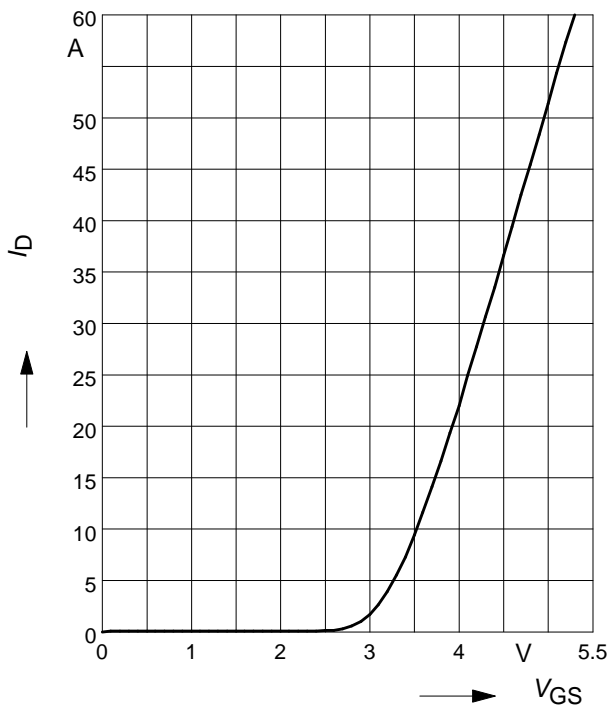

8 Typ. forward transconductance

$g_{fs} = f(I_D); T_j = 25^\circ\text{C}$
parameter: g_{fs}

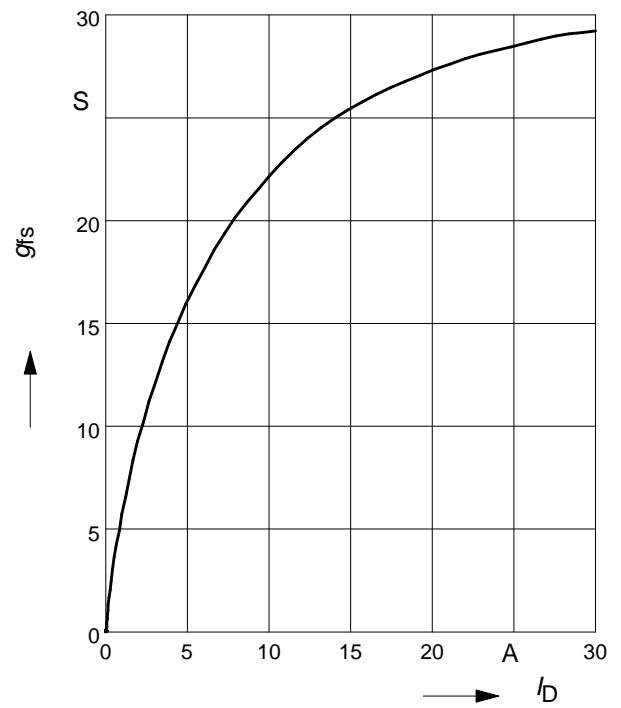

9 Drain-source on-state resistance

$$R_{DS(on)} = f(T_j)$$

parameter : $I_D = 15 \text{ A}$, $V_{GS} = 10 \text{ V}$

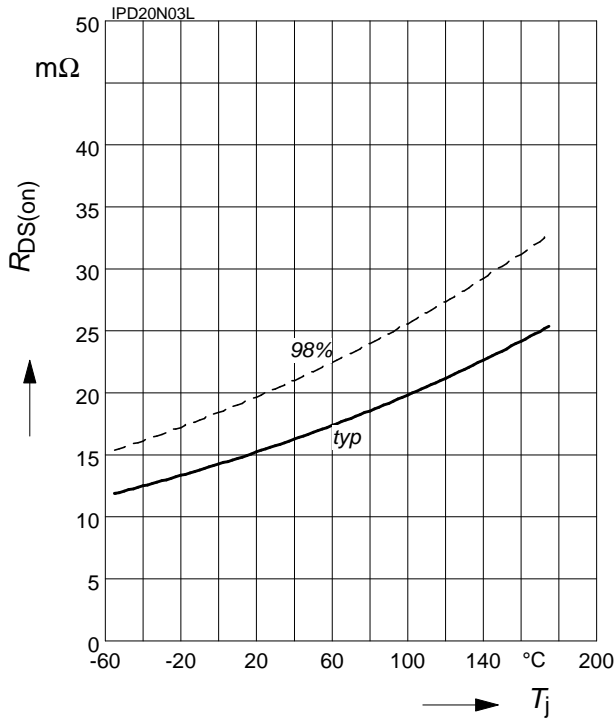

10 Typ. gate threshold voltage

$$V_{GS(th)} = f(T_j)$$

parameter: $V_{GS} = V_{DS}$

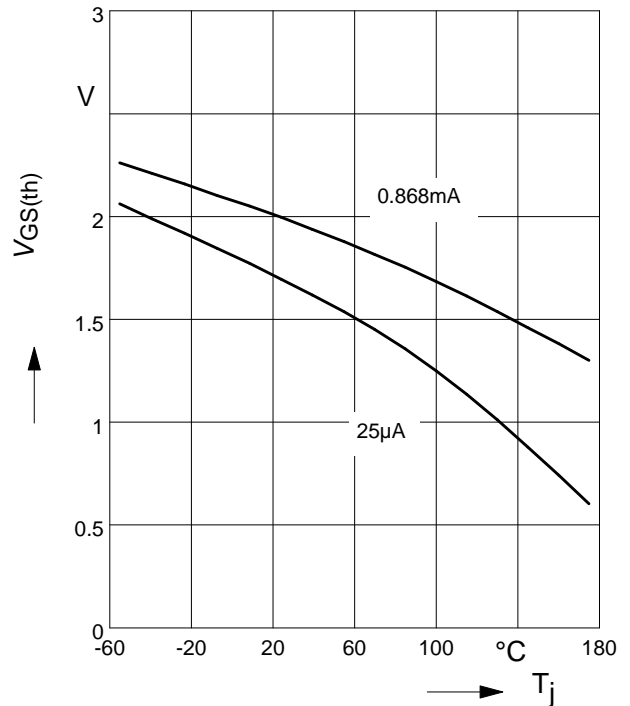

11 Typ. capacitances

$$C = f(V_{DS})$$

parameter: $V_{GS} = 0 \text{ V}$, $f = 1 \text{ MHz}$

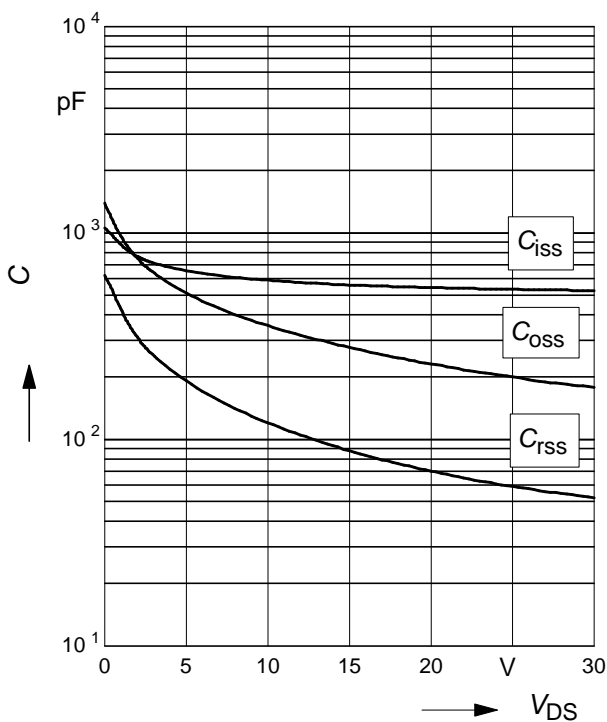

12 Forward character. of reverse diode

$$I_F = f(V_{SD})$$

parameter: T_j , $t_p = 80 \mu\text{s}$

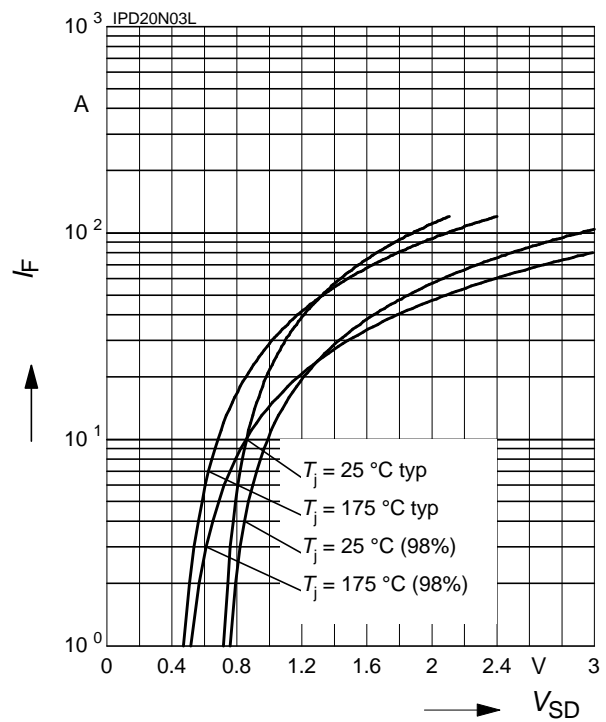

13 Typ. avalanche energy

$$E_{AS} = f(T_j)$$

par.: $I_D = 15 \text{ A}$, $V_{DD} = 25 \text{ V}$, $R_{GS} = 25 \Omega$

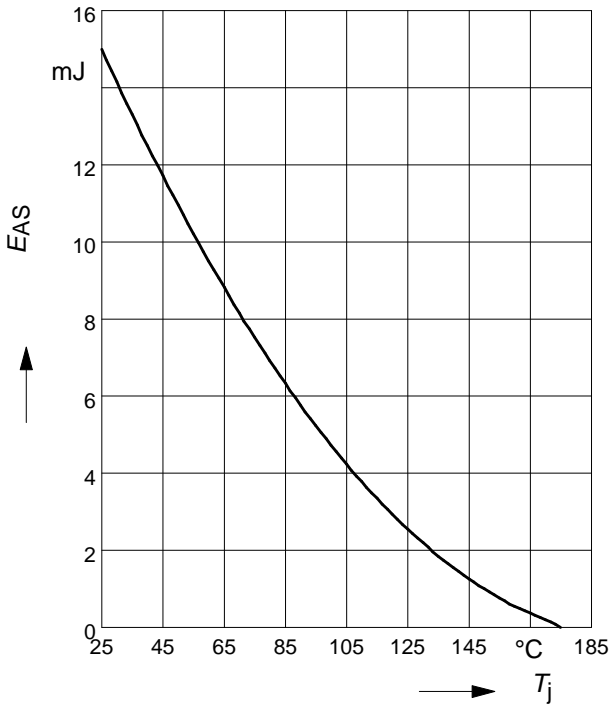

15 Drain-source breakdown voltage

$$V_{(BR)DSS} = f(T_j)$$

parameter: $I_D = 10 \text{ mA}$

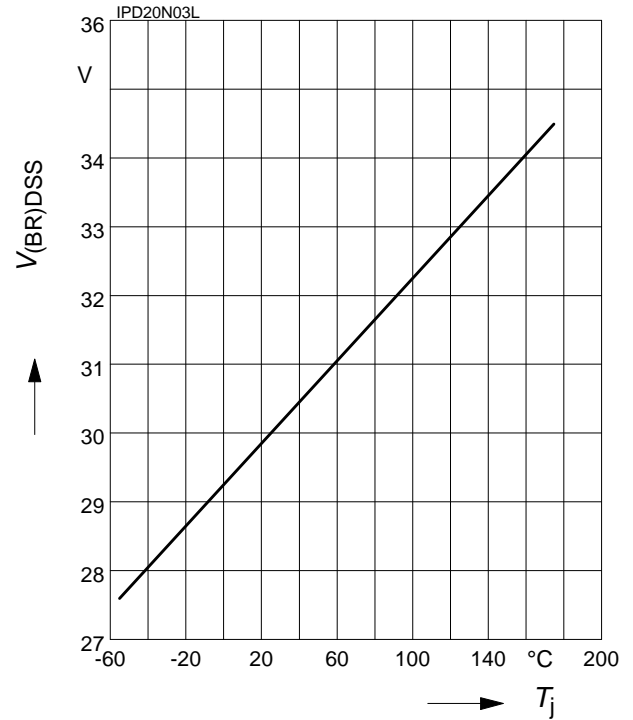

14 Typ. gate charge

$$V_{GS} = f(Q_{Gate})$$

parameter: $I_D = 15 \text{ A pulsed}$

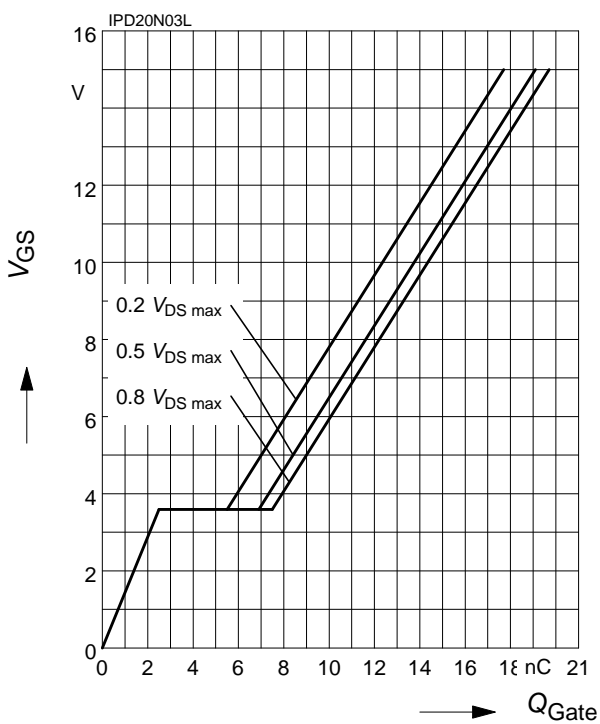

TO-252-3-1 Package outline

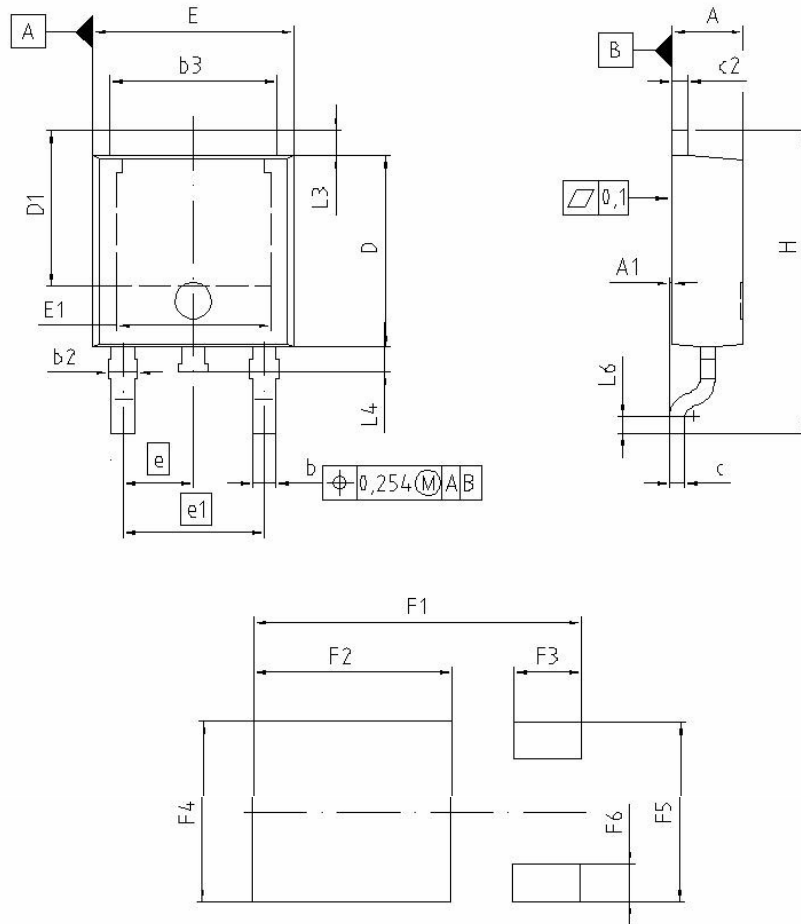

DIM	MILLIMETERS		INCHES	
	MIN	MAX	MIN	MAX
A	2.184	2.388	0.086	0.094
A1	0.000	0.150	0.000	0.006
b	0.635	0.889	0.025	0.035
b2	0.650	1.150	0.025	0.045
b3	5.004	5.500	0.197	0.217
c	0.460	0.580	0.018	0.023
c2	0.460	0.980	0.018	0.039
D	5.969	6.223	0.235	0.245
D1	5.020	5.320	0.198	0.209
E	6.400	6.731	0.252	0.265
E1	4.900	5.100	0.193	0.201
e	2,286		0.090	
e1	4,572		0.180	
N	3		3	
H	9.400	10.084	0.370	0.397
L3	0.900	1.118	0.035	0.044
L4	0.650	1.016	0.026	0.040
L6	0.510	0.686	0.020	0.027
F1	10.500	10.700	0.413	0.421
F2	6.300	6.500	0.248	0.256
F3	2.100	2.300	0.083	0.091
F4	5.700	5.900	0.224	0.232
F5	5.660	5.860	0.222	0.231
F6	1.100	1.300	0.043	0.051

REFERENCE
JEDEC TO252

SCALE
0 2.0 4mm

EUROPEAN PROJECTION

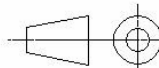

ISSUE DATE
20-07-2005

FILE
TO252_1

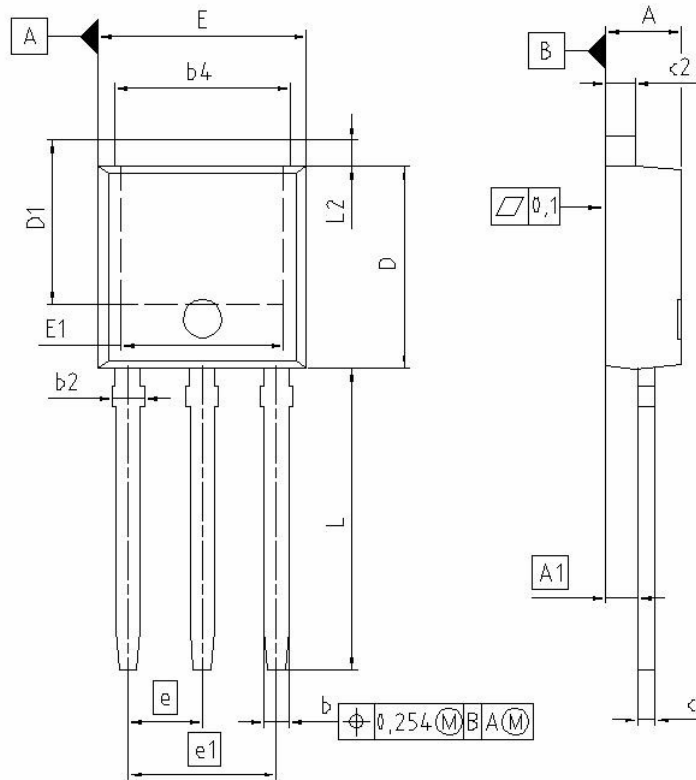

DIM	MILLIMETERS		INCHES	
	MIN	MAX	MIN	MAX
A	2.159	2.413	0.085	0.095
A1	0.900	1.118	0.035	0.044
b	0.650	0.850	0.026	0.033
b2	0.650	1.150	0.026	0.045
b4	5.004	5.500	0.197	0.217
c	0.457	0.580	0.018	0.023
c2	0.737	0.980	0.029	0.039
D	5.969	6.223	0.235	0.245
D1	5.100	6.121	0.201	0.241
E	6.400	6.731	0.252	0.265
E1	4.850	5.207	0.191	0.205
e	2.280		0.090	
e1	4.570		0.180	
N	3		3	
L	8.900	9.525	0.350	0.375
L1	0.900	1.143	0.035	0.045

REFERENCE
JEDEC TO251

SCALE

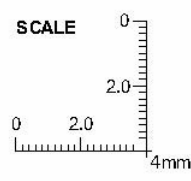

EUROPEAN PROJECTION

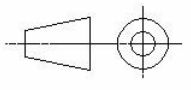

ISSUE DATE
20-07-2005

FILE
TO251_1

Published by
Infineon Technologies AG,
Bereichs Kommunikation
St.-Martin-Strasse 53,
D-81541 München
© Infineon Technologies AG 1999
All Rights Reserved.

Attention please!

The information herein is given to describe certain components and shall not be considered as warranted characteristics.

Terms of delivery and rights to technical change reserved.

We hereby disclaim any and all warranties, including but not limited to warranties of non-infringement, regarding circuits, descriptions and charts stated herein.

Infineon Technologies is an approved CECC manufacturer.

Information

For further information on technology, delivery terms and conditions and prices please contact your nearest Infineon Technologies Office in Germany or our Infineon Technologies Representatives worldwide (see address list).

Warnings

Due to technical requirements components may contain dangerous substances.

For information on the types in question please contact your nearest Infineon Technologies Office.

Infineon Technologies Components may only be used in life-support devices or systems with the express written approval of Infineon Technologies, if a failure of such components can reasonably be expected to cause the failure of that life-support device or system, or to affect the safety or effectiveness of that device or system. Life support devices or systems are intended to be implanted in the human body, or to support and/or maintain and sustain and/or protect human life. If they fail, it is reasonable to assume that the health of the user or other persons may be endangered.