

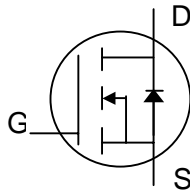

N-channel Enhancement-mode Power MOSFET

- Low On-Resistance**
- Simple Drive Requirement**
- Fast Switching Characteristics**



BV_{DSS}	300V
$R_{DS(ON)}$	66mΩ
I_D	36A

Description

Advanced Power MOSFETs from APEC provide the designer with the best combination of fast switching, low on-resistance and cost-effectiveness.

The AP80N30W-HF-3 is in the TO-3P through-hole package which is widely used in higher power commercial and industrial applications where an attached heatsink is required.

This device is well suited for use in applications such as motor drives, inverters and DC/DC converters.

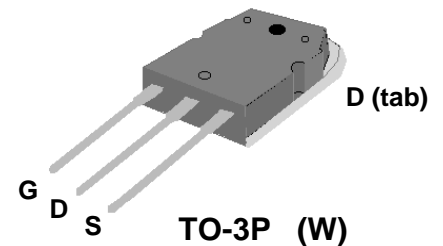

Absolute Maximum Ratings

Symbol	Parameter	Rating	Units
V_{DS}	Drain-Source Voltage	300	V
V_{GS}	Gate-Source Voltage	±30	
I_D at $T_C=25^\circ C$	Continuous Drain Current	36	A
I_{DM}	Pulsed Drain Current ¹	144	A
I_{DR}	Body-Drain Diode Reverse Drain Current	36	A
$I_{DR(PULSE)}$	Body-Drain Diode Reverse Drain Peak Current ¹	144	A
P_D at $T_C=25^\circ C$	Total Power Dissipation	208	W
	Linear Derating Factor	1.67	W/°C
I_{AR}	Avalanche Current	30	A
E_{AR}	Single Pulse Avalanche Energy ³	45	mJ
T_{STG}	Storage Temperature Range	-55 to 150	°C
T_J	Operating Junction Temperature Range	-55 to 150	°C

Thermal Data

Symbol	Parameter	Value	Units
Rthj-c	Maximum Thermal Resistance, Junction-case	0.6	°C/W
Rthj-a	Maximum Thermal Resistance, Junction-ambient	40	°C/W

Ordering Information

AP80N30W-HF-3TB : in RoHS-compliant, halogen-free TO-3P, shipped in tubes (1440 pcs/carton)



Electrical Specifications at $T_j=25^\circ\text{C}$ (unless otherwise specified)

Symbol	Parameter	Test Conditions	Min.	Typ.	Max.	Units
BV_{DSS}	Drain-Source Breakdown Voltage	$V_{GS}=0V, I_D=250\mu A$	300	-	-	V
$R_{DS(ON)}$	Static Drain-Source On-Resistance ²	$V_{GS}=10V, I_D=30A$	-	-	66	m Ω
$V_{GS(th)}$	Gate Threshold Voltage	$V_{DS}=V_{GS}, I_D=250\mu A$	3	-	4.5	V
g_{fs}	Forward Transconductance	$V_{DS}=10V, I_D=30A$	-	56	-	S
I_{DSS}	Drain-Source Leakage Current	$V_{DS}=300V, V_{GS}=0V$	-	-	10	μA
	Drain-Source Leakage Current ($T_j=125^\circ\text{C}$)	$V_{DS}=240V, V_{GS}=0V$	-	-	200	μA
I_{GSS}	Gate-Source Leakage	$V_{GS}=\pm 30V, V_{DS}=0V$	-	-	± 0.1	μA
Q_g	Total Gate Charge ²	$I_D=30A$	-	117	180	nC
Q_{gs}	Gate-Source Charge	$V_{DS}=240V$	-	28	-	nC
Q_{gd}	Gate-Drain ("Miller") Charge	$V_{GS}=10V$	-	42	-	nC
$t_{d(on)}$	Turn-on Delay Time ²	$V_{DS}=150V$	-	40	-	ns
t_r	Rise Time	$I_D=30A$	-	90	-	ns
$t_{d(off)}$	Turn-off Delay Time	$R_G=10\Omega$	-	165	-	ns
t_f	Fall Time	$V_{GS}=10V$	-	95	-	ns
C_{iss}	Input Capacitance	$V_{GS}=0V$	-	5700	9120	pF
C_{oss}	Output Capacitance	$V_{DS}=15V$	-	525	-	pF
C_{rss}	Reverse Transfer Capacitance	$f=1.0\text{MHz}$	-	10	-	pF

Source-Drain Diode

Symbol	Parameter	Test Conditions	Min.	Typ.	Max.	Units
V_{SD}	Forward On Voltage ²	$I_S=30A, V_{GS}=0V$	-	-	1.5	V
t_{rr}	Reverse Recovery Time ²	$I_S=12A, V_{GS}=0V$	-	310	-	ns
Q_{rr}	Reverse Recovery Charge	$dI/dt=100A/\mu s$	-	3.5	-	μC

Notes:

1. Pulse width limited by maximum junction temperature.
2. Pulse test
3. Starting $T_j=25^\circ\text{C}$, $V_{DD}=50V$, $L=1\text{mH}$, $R_G=25\Omega$, $I_{AS}=30A$.

THIS PRODUCT IS SENSITIVE TO ELECTROSTATIC DISCHARGE, PLEASE HANDLE WITH CAUTION.

USE OF THIS PRODUCT AS A CRITICAL COMPONENT IN LIFE SUPPORT OR OTHER SIMILAR SYSTEMS IS NOT AUTHORIZED.

APEC DOES NOT ASSUME ANY LIABILITY ARISING OUT OF THE APPLICATION OR USE OF ANY PRODUCT OR CIRCUIT DESCRIBED HEREIN; NEITHER DOES IT CONVEY ANY LICENSE UNDER ITS PATENT RIGHTS, NOR THE RIGHTS OF OTHERS.

APEC RESERVES THE RIGHT TO MAKE CHANGES WITHOUT FURTHER NOTICE TO ANY PRODUCTS HEREIN TO IMPROVE RELIABILITY, FUNCTION OR DESIGN.



Typical Electrical Characteristics

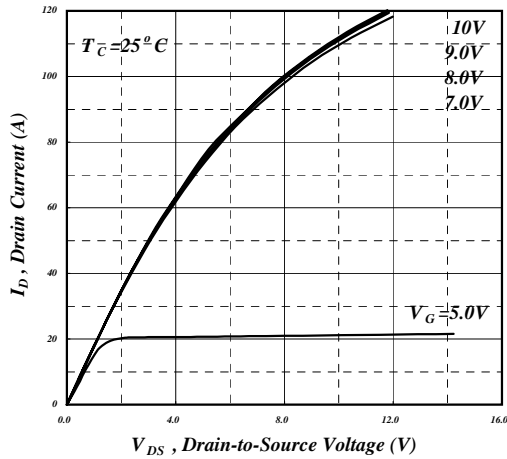

Fig 1. Typical Output Characteristics

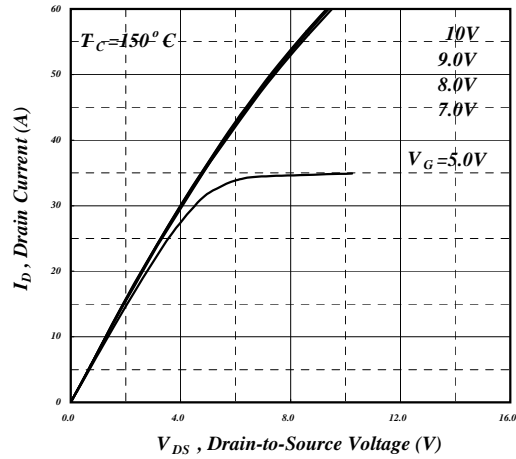

Fig 2. Typical Output Characteristics

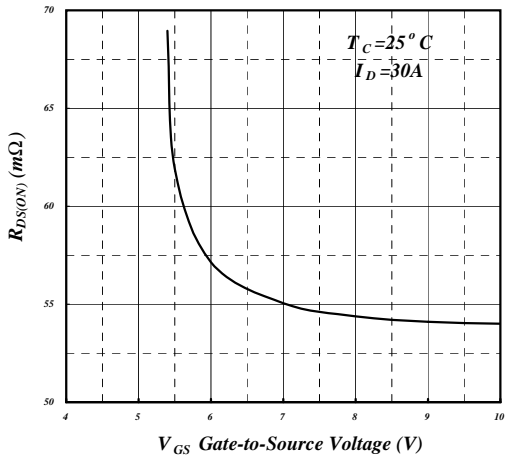

Fig 3. On-Resistance vs. Gate Voltage

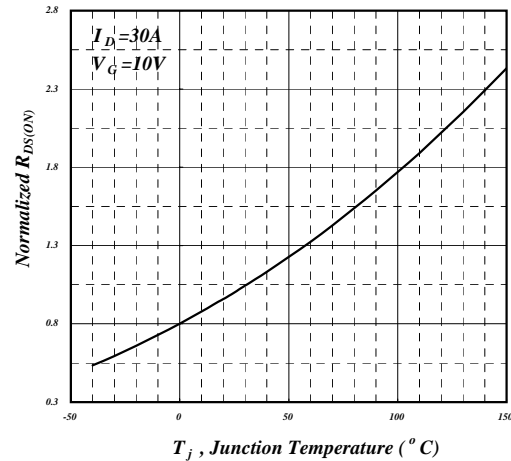

Fig 4. Normalized On-Resistance vs. Junction Temperature

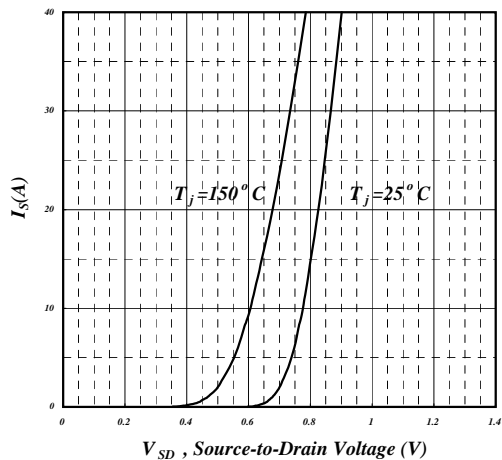

Fig 5. Forward Characteristic of Reverse Diode

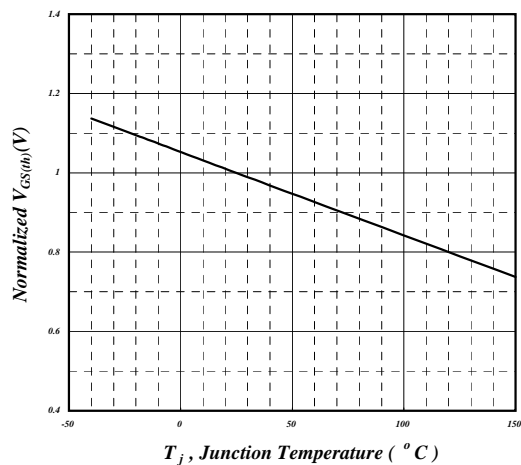

Fig 6. Gate Threshold Voltage vs. Junction Temperature



Typical Electrical Characteristics (cont.)

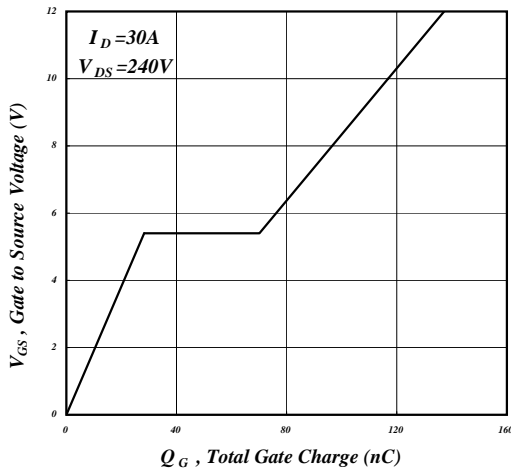

Fig 7. Gate Charge Characteristics

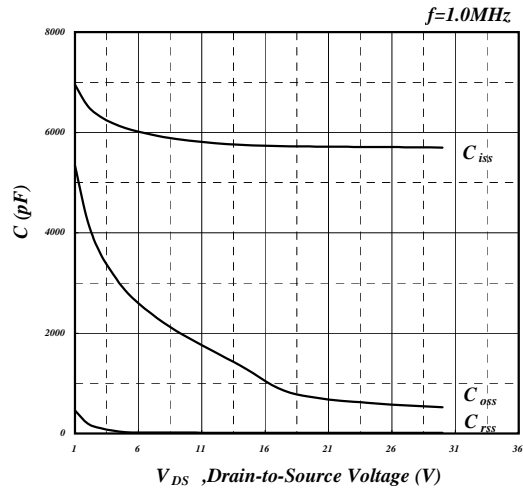

Fig 8. Typical Capacitance Characteristics

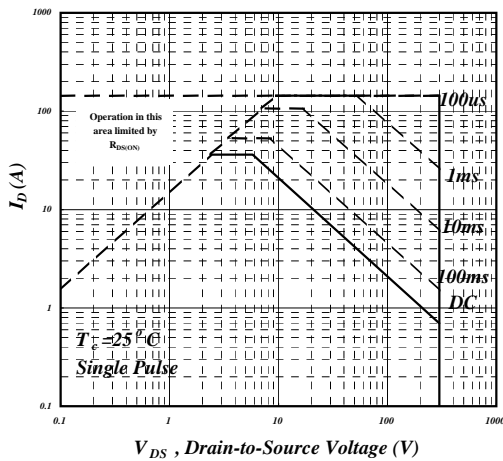

Fig 9. Maximum Safe Operating Area

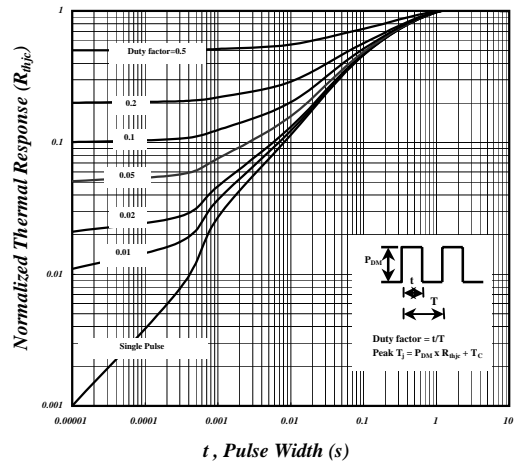

Fig 10. Effective Transient Thermal Impedance

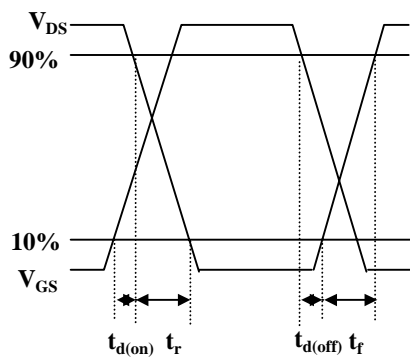

Fig 11. Switching Time Waveform

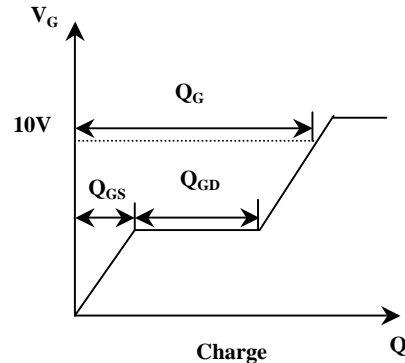
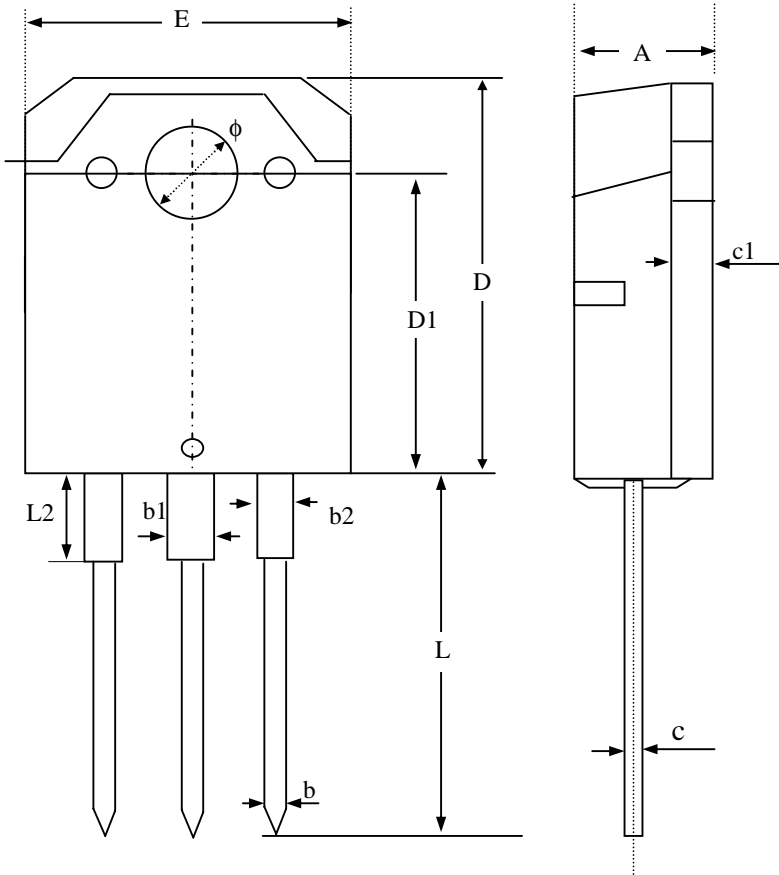

Fig 12. Gate Charge Waveform



Package Dimensions: TO-3P



SYMBOLS	Millimeters		
	MIN	NOM	MAX
A	4.50	4.80	5.10
b	0.80	1.00	1.30
b1	1.80	2.50	3.20
b2	1.30	--	2.30
c	0.40	0.60	0.90
c1	1.40	--	2.20
D	19.70	20.00	20.30
D1	14.70	15.00	15.30
E	15.30	--	16.10
e	4.45	5.45	6.45
L	17.50	--	20.50
L2	1.00	--	3.70
ϕ	3.00	3.20	3.40

1. All dimensions are in millimeters.
2. Dimensions do not include mold protrusions.

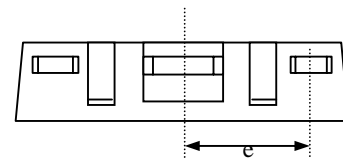

Marking Information:

