

Hybrid IC IGBT Gate Driver

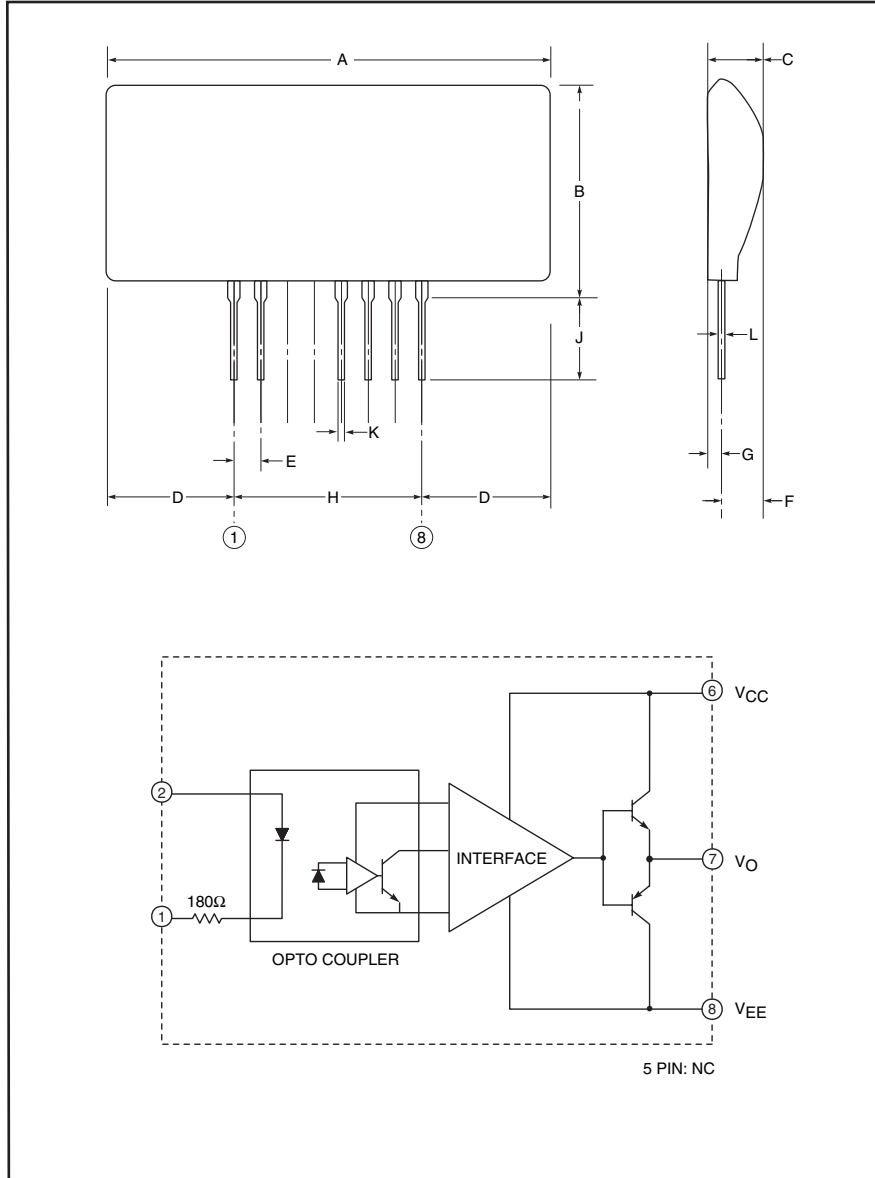

Outline Drawing and Circuit Diagram

Dimensions	Inches	Millimeters
A	1.85 Max.	47.0 Max.
B	1.063 Max.	27.0 Max.
C	0.28 Max.	7.0 Max.
D	0.59 Max.	15.0 Max.
E	0.10	2.54
F	0.216 Max.	5.5 Max.
G	0.08 Max.	2.0 Max.
H	0.70	17.78
J	0.18±0.06	4.5±1.5
K	0.03	0.75
L	0.02	0.5

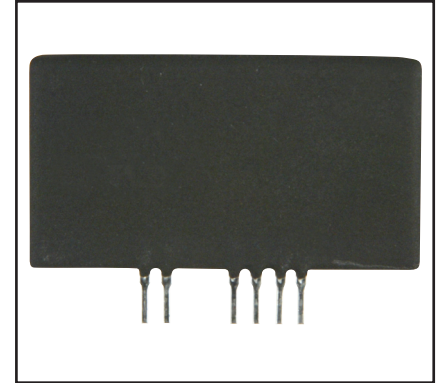

Description:

VLA513-01 is a hybrid integrated circuit designed for driving IGBT modules. This device operates as an isolation amplifier for these modules and provides the required electrical isolation between the input and output with an opto-coupler.

Features:

- Propagation Delay time: 0.2 μ s (Typical)
- Output is ± 5 A maximum
- Two Supply Drive (VCC: 15 Volts, VEE: -10 Volts)
- SIP Outline Allows More Space on Mounting Area
- Electrical Isolation Voltage Between Input and Output (2500 V_{rms} for 1 Minute)
- TTL Compatible Input

Application:

To drive IGBT modules for welding, induction heating, or inverters.

Recommended IGBT Modules:

NFH Series IGBTs –
V_{CES} = 600V & 1200V up to
200A class (f: up to 60kHz),
400A class (f: up to 30kHz)

NF Series IGBTs –
V_{CES} = 600V up to 600A
V_{CES} = 1200V up to 400A

VLA513-01
Hybrid IC IGBT Gate Driver

Absolute Maximum Ratings, $T_a = 25^\circ\text{C}$ unless otherwise specified

Characteristics	Symbol	VLA513-01	Units
Supply Voltage, DC	V_{CC}	18	Volts
	V_{EE}	-12	Volts
Input Signal Voltage (Applied between Pin 1 - 2, 50% Duty Cycle, Pulse Width 1ms)	V_I	-1 ~ 7	Volts
Output Voltage (When the Output Voltage is "H")	V_O	V_{CC}	Volts
Output Current (Pulse Width 2 μ s, $f \leq 20\text{kHz}$)	I_{OHP}	-5	Amperes
	I_{OLP}	5	Amperes
Isolation Voltage (Sine Wave Voltage 60HZ, for 1 Minute)	V_{ISO}	2500	V_{rms}
Case Temperature ¹ (Surface Temperature Opto-coupler Location) ^{***}	T_{C1}	85	$^\circ\text{C}$
Operating Temperature (No Condensation Allowable)	T_{opr}	-20 to 70	$^\circ\text{C}$
Storage Temperature (No Condensation Allowable)	T_{stg}	-25 to 100*	$^\circ\text{C}$

*Differs from temperature cycle condition.

Electrical and Mechanical Characteristics, $T_a = 25^\circ\text{C}$ unless otherwise specified, $V_{CC} = 15\text{V}$, $V_{EE} = -10\text{V}$

Characteristics	Symbol	Test Conditions	Min.	Typ.	Max.	Units
Supply Voltage	V_{CC}	Recommended Range	14	15	—	Volts
	V_{EE}	Recommended Range	-5	-8	-12	Volts
Pull-up Voltage on Input Side	V_{IN}	Recommended Range	4.75	5	5.25	Volts
"H" Input Current	I_{IH}	Recommended Range	9.5	10.0	14.0	mA
Switching Frequency	f	Recommended Range	—	—	60	kHz
Gate Resistance	R_G	Recommended Range	2	—	—	Ω
"H" Input Current	I_{IH}	$V_{IN} = 5\text{V}$	—	10	—	mA
"H" Output Voltage	V_{OH}	—	13	14	—	Volts
"L" Output Voltage	V_{OL}	—	-8	-9	—	Volts
"L-H" Propagation Time	t_{PLH}	$I_{IH} = 16\text{mA}$	0.1	0.2	0.5	μs
"L-H" Rise Time	t_r	$I_{IH} = 16\text{mA}$	—	0.3	1	μs
"H-L" Propagation Time	t_{PHL}	$I_{IH} = 16\text{mA}$	0.05	0.2	0.5	μs
"H-L" Fall Time	t_f	$I_{IH} = 16\text{mA}$	—	0.3	1	μs

VLA513-01
Hybrid IC IGBT Gate Driver

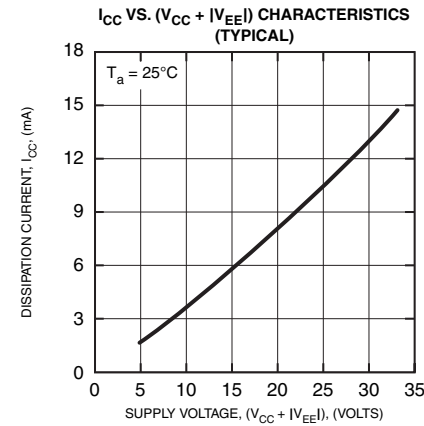
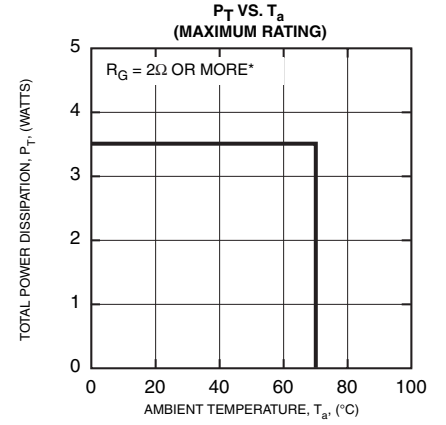
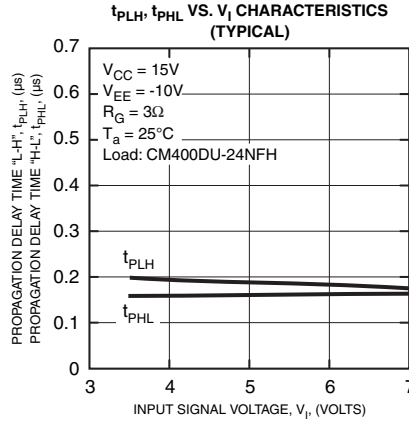
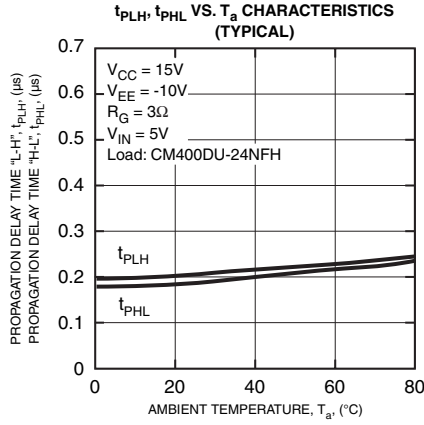

* The following numerical expression must be satisfied
 $PT > (V_{CC} + |V_{EE}|) * \{(Q_1 + |Q_2|) * f + I_{CC}\}$
 Q_1 : Gate Charge on plus bias
 Q_2 : Gate Charge on minus bias
 f : Switching frequency
 I_{CC} : Constant dissipation current of driver
 Refer to " I_{CC} VS. $(V_{CC} + |V_{EE}|)$ Characteristics"

Application Circuit

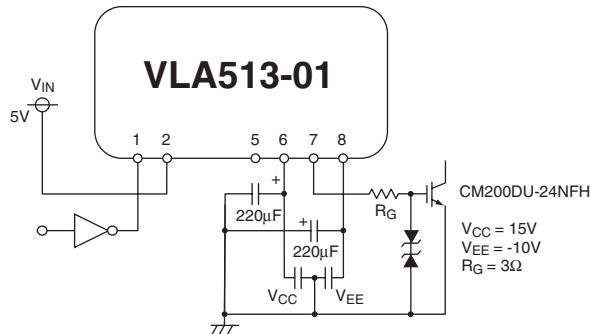

Notes:

- (1) Power supply decoupling capacitors should be connected as close as possible to the pins of the gate driver.
- (2) Power supply decoupling capacitors should be good quality, low ESR types.
- (3) Printed circuit layout should minimize wiring lengths and utilize shielding layers to suppress noise.

Switching Time Definitions

