

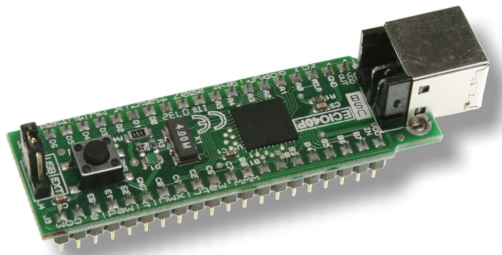

- **USB programmable microcontrollers**
- **0.6" DIP footprint**
- **Supplied with a free version of Flowcode**
- **E-blocks compatible**

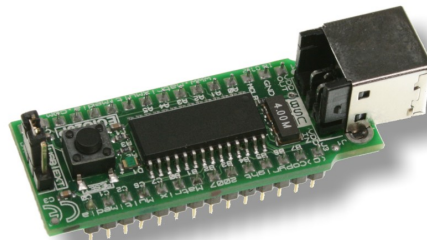

ECIO40P



ECIO28P

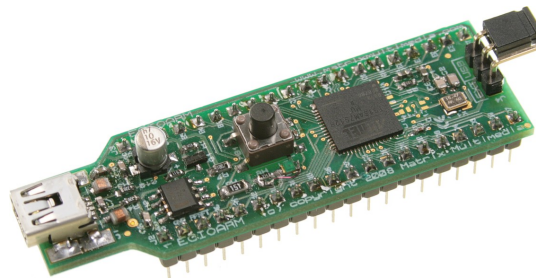

ECRM40



English



Spanish



Greek



Thai



Dutch



French



Romanian



Finish



Italian



Vietnamese



German



Slovenian



Danish



Hungarian



Japanese



Slovak



Mandarin



Turkish



Portuguese



# Introduction

## What does it do?

ECIO devices are powerful USB programmable microcontrollers with 28 and 40 pin DIL (0.6") footprints.

## Benefits

- Allows you to add USB programmability to your projects
- Low cost microcontroller programming, platform for development and learning

## Features

- Programmable from USB
- Includes bootloader software
- Can draw power from USB
- Usable with LabView and VB, C++ etc

## Description

The ECIO family of USB programmable microcontrollers provides an incredibly simple way of adopting microcontroller technology into your projects. The device behaves just like a normal microcontroller - but when you plug the USB lead in and press the reset switch you can send a new program to the device. This makes the ECIO one of the lowest cost USB programmers in the World.

Currently there are three products in the range: ECIO28P and ECIO40P, and the ECRM40. ECIO-28P and ECIO- 40P devices are based on PICmicro 18 series devices - the 18F2455 and the 18F4455 respectively. The ECRM40 is based on an Atmel AT91 ARM 7 processor.

ECIO microcontrollers are pre-programmed with a bootloader program which allows you to send a new program to the microcontroller via USB. ECIO is compatible with hex code from any appropriate compiler. ECIOs are directly compatible with Flowcode - a graphical programming language which greatly simplifies the code generation process - but can also be used with any C compiler.

ECIO is suitable for use where direct programming from USB is required: for projects, or where systems need reprogramming in the field.

ECIO is well supported with a wide range of learning and development tools including Flowcode and E-blocks.

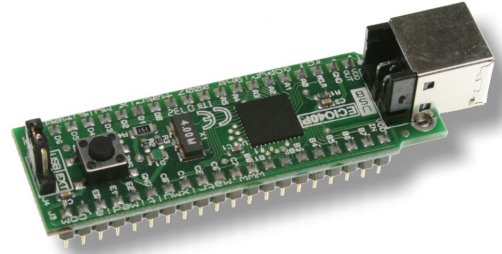

ECIO-40P

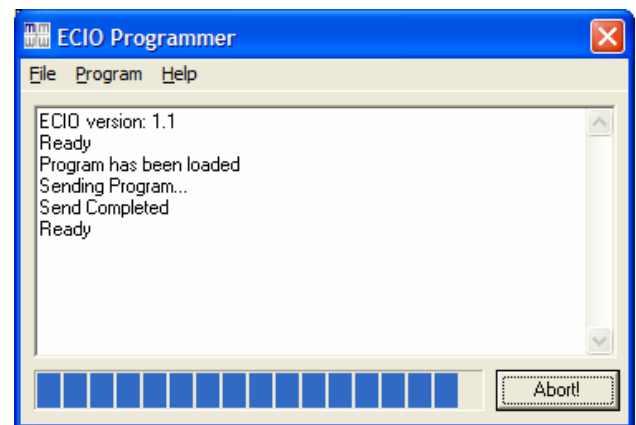

[Download software](#)



# Package details - ECIO28P, ECIO40P

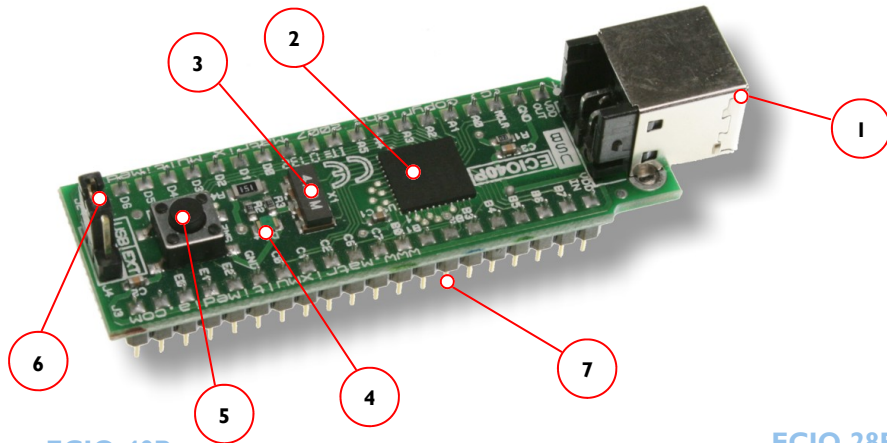

- 1.USB socket
- 2.PICmicro microcontroller device
- 3.4MHz ceramic resonator
- 4.Power / Programming LED
- 5.Reset switch
- 6.Power selection jumper
- 7.Device pins - 0.6" DIL compatible

Picture shows ECIO-40P. ECIO-28P is similar.

## ECIO-40P

Processor	8 bit 18 series PICmicro
Base chip:	PIC18F4455
Oscillator:	4MHz ext., 48MHz internal
IO lines:	30
A/D:	13 x10 bit
A/D sample rate	100ksps
Program memory	24K Bytes
RAM	2K bytes
EEPROM	256 bytes
Power	5V, USB or external
PWM channels	5
Timers	1 x 8 bit, 3 x 16 bit
Interfaces	EUSART, MI2C, SPI, USB2.0
Package	40 pin DIP, 0.6", compatible

## ECIO-28P

Processor	8 bit 18 series PICmicro
Base chip:	PIC18F2455
Oscillator:	4MHz ext., 48MHz internal
IO lines:	19
A/D:	10 x10 bit
A/D sample rate	100ksps
Program memory	24K Bytes
RAM	2K bytes
EEPROM	256 bytes
Power	5V, USB or external
PWM channels	2
Timers	1 x 8 bit, 3 x 16 bit
Interfaces	EUSART, MI2C, SPI, USB2.0
Package	28 pin, 0.6", DIP compatible

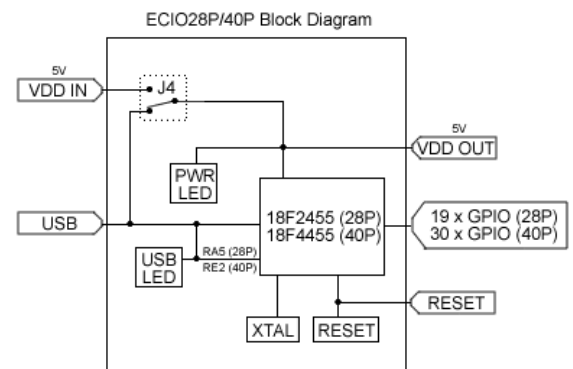
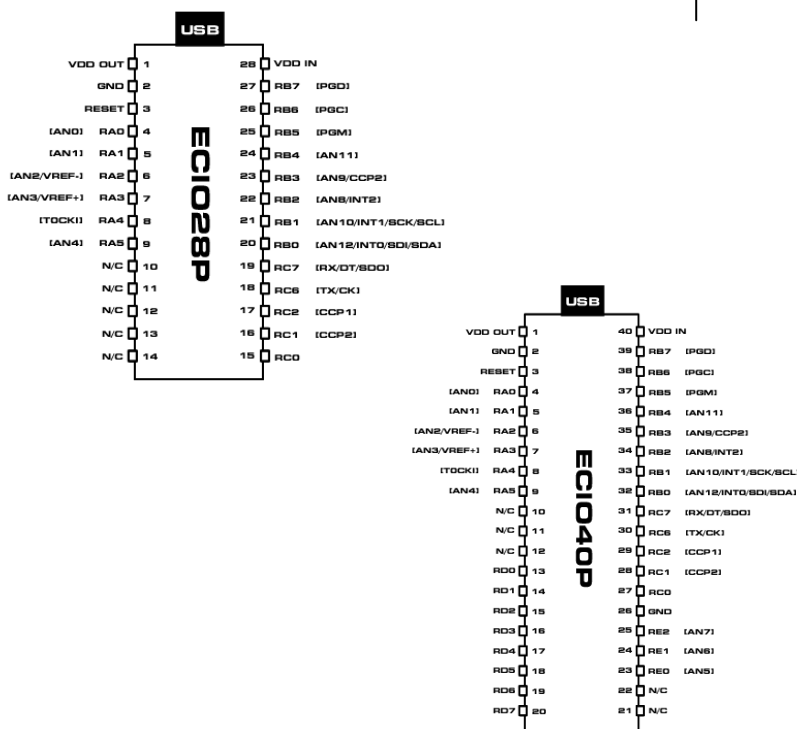

# Package details - ECRM40P

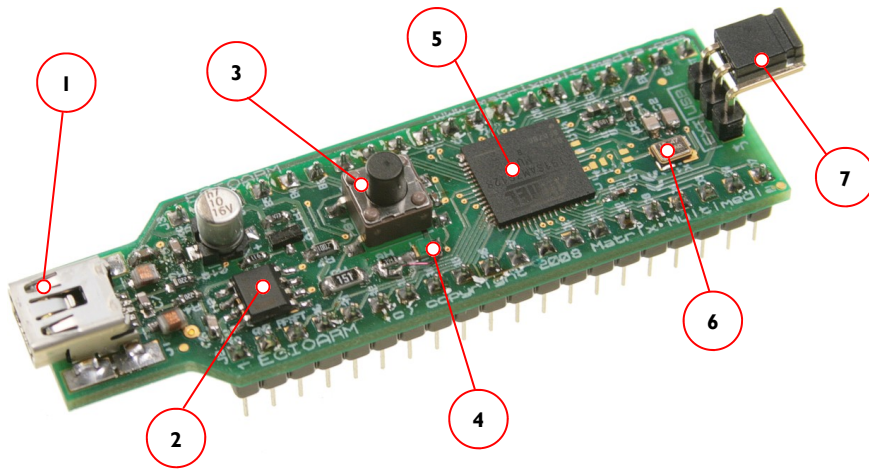

- 1. USB socket - miniature version
- 2. 3.3V regulator
- 3. Reset switch
- 4. Power / Programming LED
- 5. ARM microcontroller device
- 6. 18.43 MHz ceramic resonator
- 7. Power selection jumper
- 8. Device pins

## ECRM40

Processor	32 bit, AT91 ARM 7 core
Base chip:	AT91SAM7S128
Oscillator:	18.43MHz ext, 47.92MHz internal
IO lines:	34
A/D:	8 x 10 bit
A/D sample rate	300ksps
Program memory	128K Bytes
RAM	32K bytes
EEPROM	0 (internal ROM overwrite)
Power	5V, USB or external
PWM channels	4
Timers	3 x 16 bit, 2 x 32 bit
Interfaces	2 x EUSART, MI2C, SPI, USB2.0
Package	40 pin DIP, 0.6", compatible

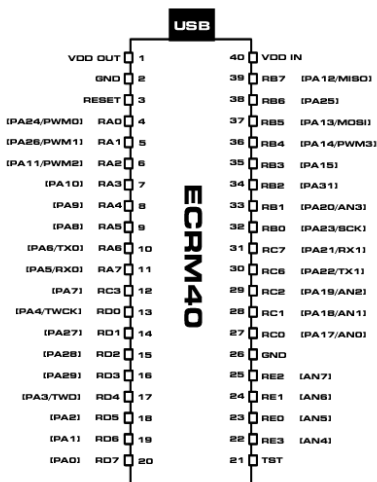

ECIO ARM Block Diagram

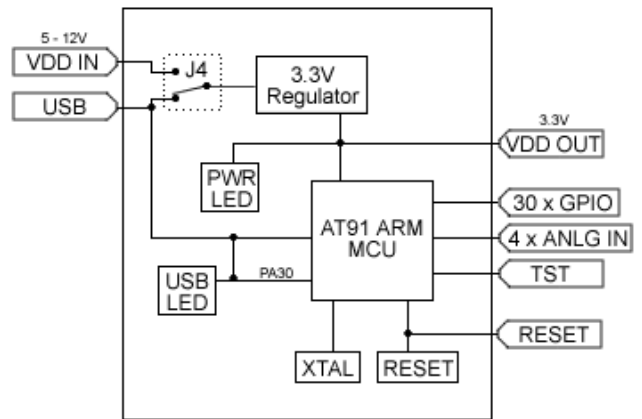

# Flowcode software

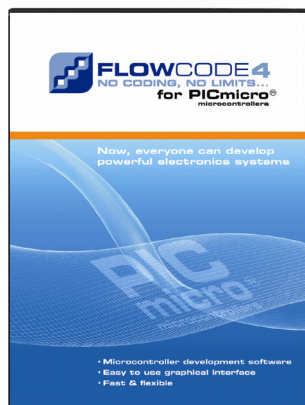
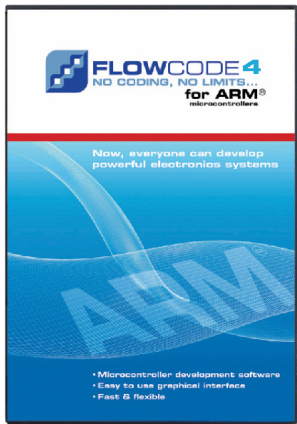

ECIO devices are fully compatible with Flowcode4 - one of the world's most advanced graphical programming languages for microcontrollers. The great advantage of Flowcode is that it allows those with little experience to create complex electronic systems in minutes. Flowcode achieves this in two steps: firstly users drag and drop flowchart symbols onto the screen, and fill in the dialog boxes when prompted. Then Flowcode compiles the flow chart into code that is downloaded to a microcontroller which executes the program.

Flowcode is available in many languages including: Danish, Dutch, English, Finnish, French, German, Greek, Spanish, (full translation) and also: Italian, Mandarin, Romanian, and Thai (menus only).

## Design

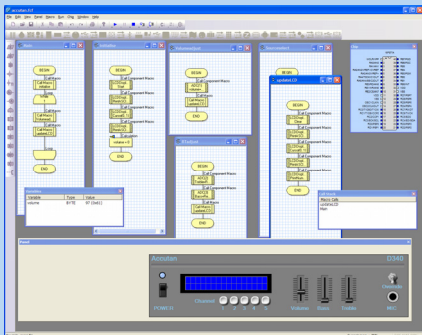

Flowcode contains standard flow chart icons and electronic components that allow to you to create a virtual electronic system on screen. Drag icons and components onto the screen to create a program, then click on them to set properties and actions.

- Easy to use interface
- Allows complex programs to be developed and managed quickly
- All I/O and expansion options are supported in Flowcode

## Simulate

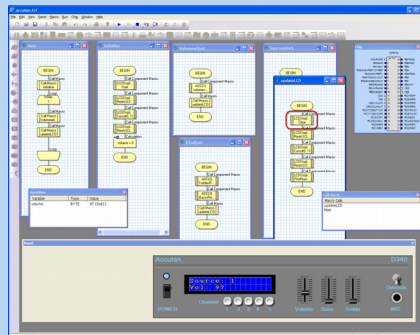

Once your system is designed you can use Flowcode to simulate it in action. Test the system's functionality by clicking on switches or altering sensor values, and see how your program reacts to the changes in the electronic system.

- Simulation aids understanding
- Debug before download
- Shorten the design cycle

## Download

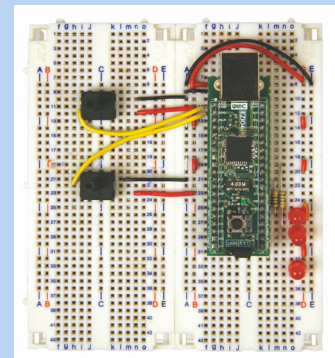

When you are happy with your design click one button to send the program directly to the ECIO device. Remove the USB lead and press the reset button and your program starts to run.

- One button download
- Compiles to C then ASM
- Link in your own C files



# ECIO™ in use

There are several ways of using the ECIO:

## With a prototype board

ECIO devices are really useful when used in conjunction with a prototype board: the ECIO unit simply plugs into the matrix of holes and the surrounding components are wired in using single strand wire. The ECIO can be used with an external power supply or the unit can draw power from the USB lead itself.

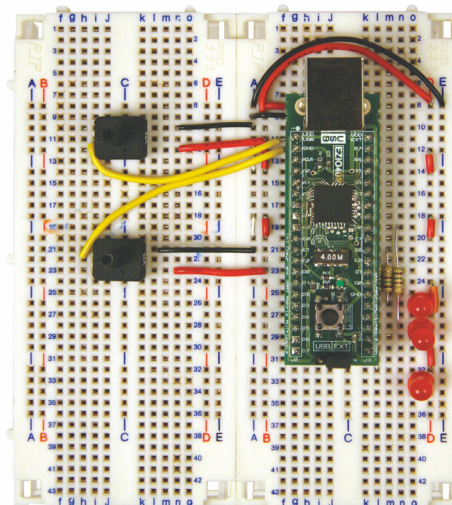

Using a proto board

## With E-blocks

If you have larger projects, or you want to connect more advanced systems together, then you can use the E-blocks adaptor panel (EB061) shown here. This allows you to connect a large range of boards from simple LED's and switches through to CAN sub-systems, etc. This is ideal for prototyping larger and more complex systems.

## With your own hardware

If you are developing your own hardware you can use the ECIO board as a component: adding ECIO to your system allows you to develop a product that can be reprogrammed in the field.

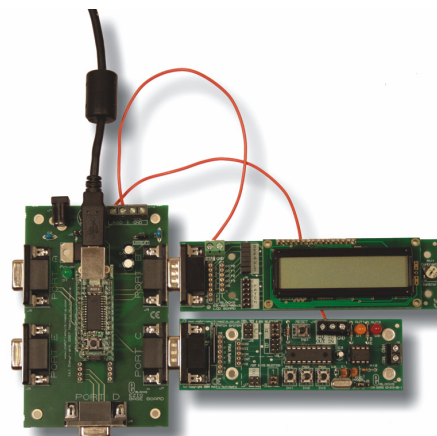

Using ECIO with E-blocks

## Use with LabView, Visual Basic and other packages

ECIO can easily be integrated with third party PC based control packages like Lab View and Visual Basic. This is enabled by a DLL and a suite of sample programs that can be downloaded to the ECIO to provide a fully controllable slave device from PC based applications.

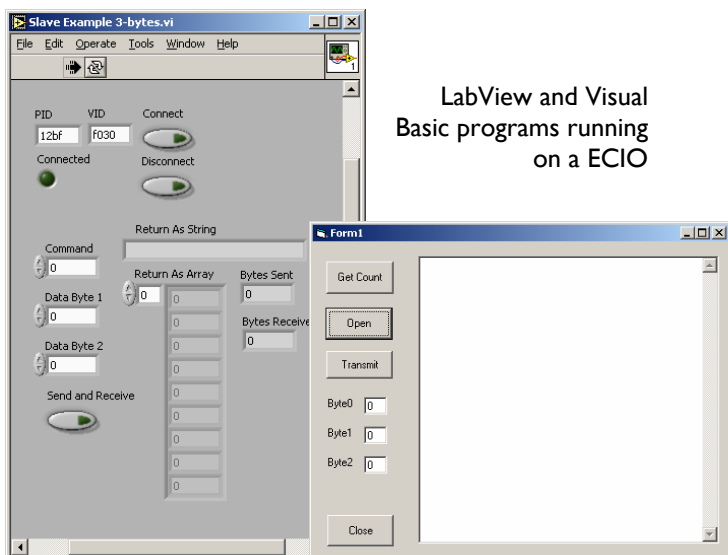

LabView and Visual Basic programs running on a ECIO

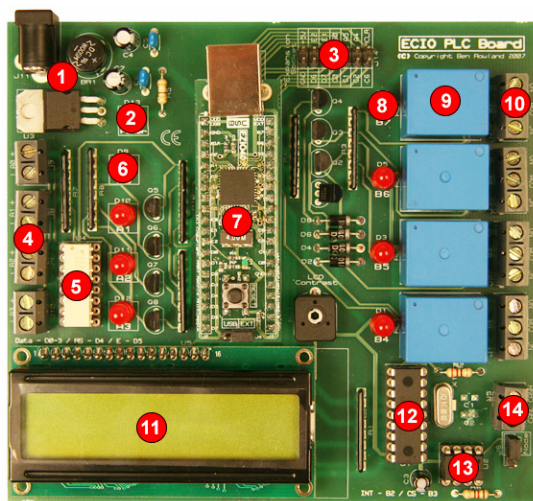

Using ECIO in a custom development



# Using FlowKit with ECIO

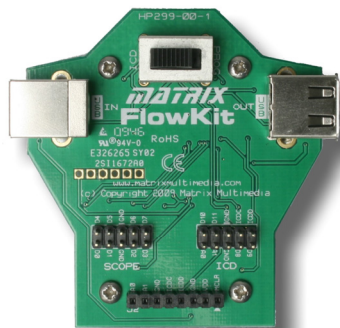

The FlowKit main board

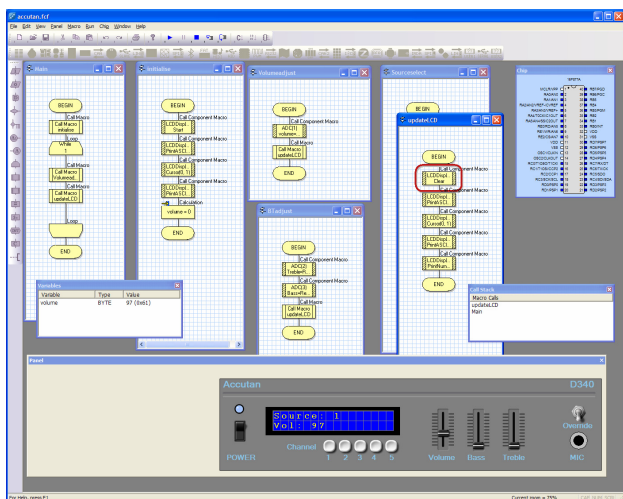

The system is controlled within Flowcode 4.2+ where the icon just executed is clearly marked

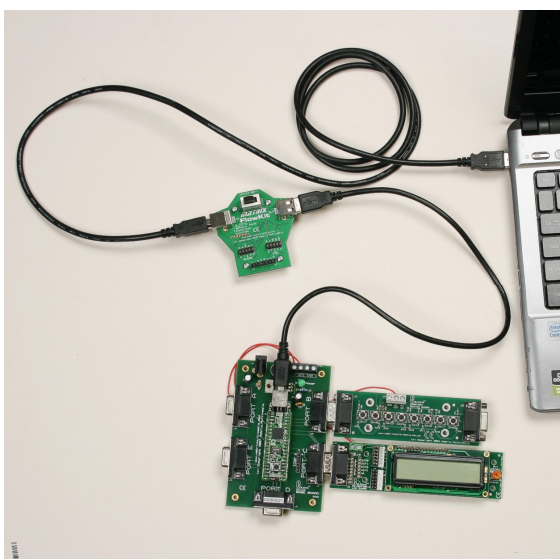

Using Flowkit with ECIO and E-blocks adaptor board

## What does it do?

The FlowKit can be connected to hardware systems to provide a real time debug facility where it is possible to step through the Flowcode program on the PC and step through the program in the hardware at the same time. This function is available with Flowcode for PICmicro V4.2 or later.

## Benefits

- Helps to solve programming problems
- Seamless program and debug

## Features

- Compatible with ECIO, MIAC and Formula Flowcode systems via the USB lead
- Available for Flowcode for PICmicro V4.2 and later
- Allows start, step, and play of programs
- Allows users to see and alter variable values

## Description

Whilst Flowcode simulation allows debug of a system to a first pass, FlowKit takes debug to a new level by running the program in the hardware and on the screen at the same time. The system is controlled from within the Flowcode environment where controls allow users to start, stop, pause and step through their program one icon at a time. Under user control the Flowcode software shows the location of the program in the flow chart, the value of all variables in the program, and allows users to alter the variable values when the program is paused.

Note that use of FlowKit with ECIO for ARM is not currently supported.

<b>Ordering information</b>	
FlowKit pack	HP299

# Product codes and ordering

## ECIO devices

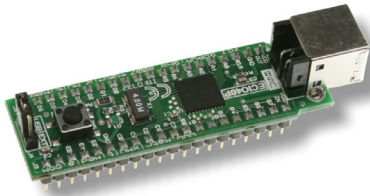

40 pin 18F4455 PICmicro device  
ECIO40P

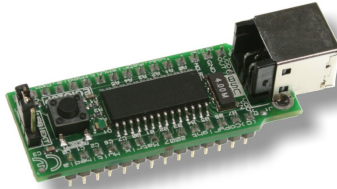

28 pin 18F2455 PICmicro device  
ECIO28P

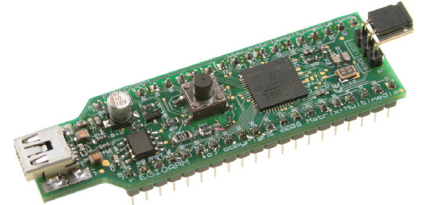

40 pin AT91 ARM device  
ECIOARM

## E-blocks application board - EB06 I

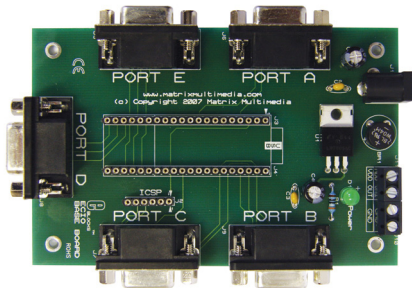

EB06 I is compatible with all ECIO devices - both ARM and PICmicro.

## Build your own PLC bundle - EB48 I



The build your own PLC bundle includes an E-blocks LED board, LCD board, Switch board, Relay board, Opto-isolator board, ECIO application board, ECIO 40 pin PIC board, international power supply, and a full copy of Flowcode version 4 for PICmicro.





Compatible with.....



...and also...

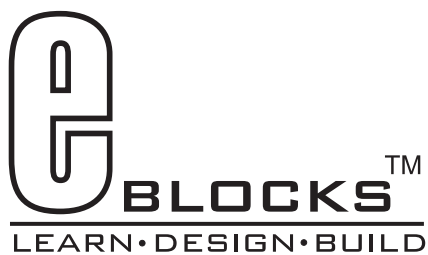

Matrix Multimedia Limited  
The Factory  
Emscote Street South  
Halifax, HX1 3AN  
England  
t: +44 (0) 1422 252380  
e: [sales@matrixmultimedia.co.uk](mailto:sales@matrixmultimedia.co.uk)  
w: [www.matrixmultimedia.com](http://www.matrixmultimedia.com)

Details correct at time of going to press. Matrix Multimedia reserves the right to change specification.