

SI-8000S Series Full-Mold, Separate Excitation Step-down Switching Mode

Features

- Compact full-mold package (equivalent to TO220)
- Output current: 3.0A
- High efficiency: 79 to 91%
- Requires only 4 discrete components
- Internally-adjusted phase correction and output voltage
- Built-in reference oscillator (60kHz)
- Built-in overcurrent and thermal protection circuits
- Built-in soft start circuit (Output ON/OFF available)

Lineup

Part Number	SI-8033S	SI-8050S	SI-8090S	SI-8120S	SI-8150S
Vo(V)	3.3	5.0	9.0	12.0	15.0
Io(A)	3.0				

Absolute Maximum Ratings

Parameter	Symbol	Ratings	Unit
DC Input Voltage	V _{IN}	43*	V
Power Dissipation	P _{D1}	18(With infinite heatsink)	W
	P _{D2}	1.5(Without heatsink, stand-alone operation)	W
Junction Temperature	T _j	+125	°C
Storage Temperature	T _{stg}	-40 to +125	°C
SW Terminal Applied Reverse Voltage	V _{SW}	-1	V
Thermal Resistance(junction to case)	θ _{J-C}	5.5	°C/W

*35V for SI-8033S

Applications

- Power supplies for telecommunication equipment
- Onboard local power supplies

Recommended Operating Conditions

Parameter	Symbol	Ratings					Unit
		SI-8033S	SI-8050S	SI-8090S	SI-8120S	SI-8150S	
DC Input Voltage Range	V _{IN}	5.5 to 28	7 to 40	12 to 40	15 to 40	18 to 40	V
Output Current Range	I _o	0 to 3.0					A
Operating Junction Temperature Range	T _{JP}	-30 to +125					°C

Electrical Characteristics

(T_a=25°C)

Parameter	Symbol	Ratings															Unit
		SI-8033S			SI-8050S			SI-8090S			SI-8120S			SI-8150S			
Output Voltage	Vo	min.	typ.	max.	min.	typ.	max.	min.	typ.	max.	min.	typ.	max.	min.	typ.	max.	V
		SI-8000S*1	3.17	3.30	3.43	4.80	5.00	5.20	8.55	9.00	9.45	11.50	12.00	12.50	14.25	15.00	
	SI-8000SS	3.234	3.30	3.366	4.90	5.00	5.10										
Efficiency	η	Conditions			Conditions			Conditions			Conditions			Conditions			%
		V _{IN} =15V, I _o =1.0A			V _{IN} =20V, I _o =1.0A			V _{IN} =21V, I _o =1.0A			V _{IN} =24V, I _o =1.0A			V _{IN} =25V, I _o =1.0A			
Oscillation Frequency	f	Conditions			Conditions			Conditions			Conditions			Conditions			kHz
		V _{IN} =15V, I _o =1.0A			V _{IN} =20V, I _o =1.0A			V _{IN} =21V, I _o =1.0A			V _{IN} =24V, I _o =1.0A			V _{IN} =25V, I _o =1.0A			
Line Regulation	ΔV _{OLINE}	Conditions			Conditions			Conditions			Conditions			Conditions			mV
		V _{IN} =8 to 28V, I _o =1.0A			V _{IN} =10 to 30V, I _o =1.0A			V _{IN} =15 to 30V, I _o =1.0A			V _{IN} =18 to 30V, I _o =1.0A			V _{IN} =21 to 30V, I _o =1.0A			
Load Regulation	ΔV _{OLOAD}	Conditions			Conditions			Conditions			Conditions			Conditions			mV
		V _{IN} =15V, I _o =0.5 to 1.5A			V _{IN} =20V, I _o =0.5 to 1.5A			V _{IN} =21V, I _o =0.5 to 1.5A			V _{IN} =24V, I _o =0.5 to 1.5A			V _{IN} =25V, I _o =0.5 to 1.5A			
Temperature Coefficient of Output Voltage	ΔVo/ΔT _a	±0.5			±0.5			±1.0			±1.0			±1.0			mV/°C
Overcurrent Protection Starting Current	I _{st}	3.1			3.1			3.1			3.1			3.1			A
		Conditions			Conditions			Conditions			Conditions			Conditions			
Soft Start Pin*2	Low-Level Voltage	V _{SSL}			0.2			0.2			0.2			0.2			V
		Conditions			Conditions			Conditions			Conditions			Conditions			
Soft Start Pin*2	Outflow Current at Low Voltage	I _{SSL}			15			25			35			35			μA
		V _{SSL} =0.2V															

*1: "S" may be printed to the right of the marking (except SI-8090S, SI-8120S, SI-8150S).

*2: Pin 5 is a soft start pin. Soft start at power on can be performed with a capacitor connected to this pin.

The output can also be turned ON/OFF with this pin.

The output is stopped by setting the voltage of this pin to V_{SSL} or lower.

Soft-start pin voltage can be changed with an open-collector drive circuit of a transistor.

When using both the soft-start and ON/OFF functions together, the discharge current from C₃ flows into the ON/OFF control transistor. Therefore, limit the current securely to protect the transistor if C₃ capacitance is large.

The ON/OFF pin is pulled up to the power supply in the IC, so applying the external voltage is prohibited.

If this pin is not used, leave it open.

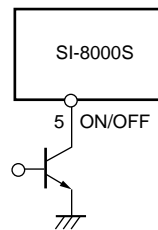

V_{OUT}. ON/OFF

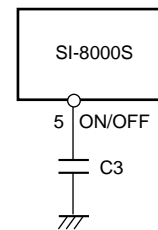

Soft start

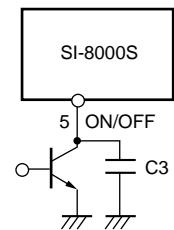

Soft start +V_{OUT}. ON/OFF

External Dimensions (TO220F-5)

(Unit : mm)

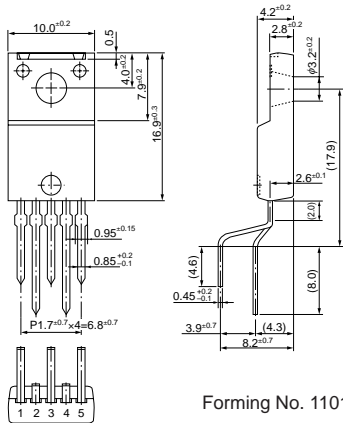

Pin Assignment

- ① VIN
- ② SWOut
- ③ GND
- ④ Vos
- ⑤ S.S

Plastic Mold Package Type
 Flammability: UL94V-0
 Product Mass: Approx. 2.3g

Block Diagram

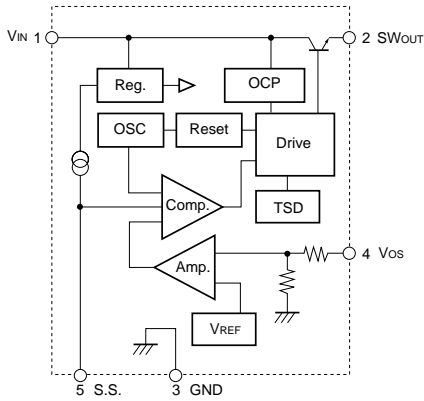

Typical Connection Diagram

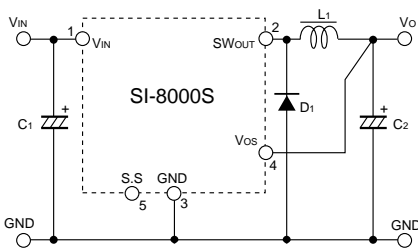

- C_{1,2} : 1000μF
- L₁ : 150μH
- D₁ : RK46(Sanken)

T_a-P_d Characteristics

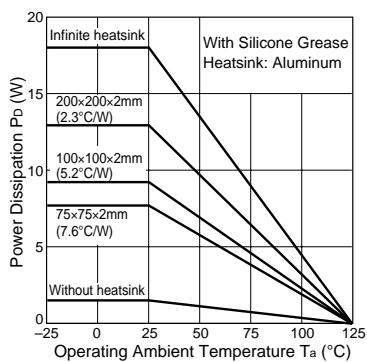

$$P_D = V_o \cdot I_o \left(\frac{100}{\eta \chi} - 1 \right) - V_F \cdot I_o \left(1 - \frac{V_o}{V_{IN}} \right)$$

The efficiency depends on the input voltage and the output current. Therefore, obtain the value from the efficiency graph and substitute the percentage in the formula above.

- V_o : Output voltage
- V_{IN} : Input voltage
- I_o : Output current
- ηχ : Efficiency (%)
- V_F : Diode D₁ forward voltage
0.5V(RK46)

Thermal design for D₁ must be considered separately.