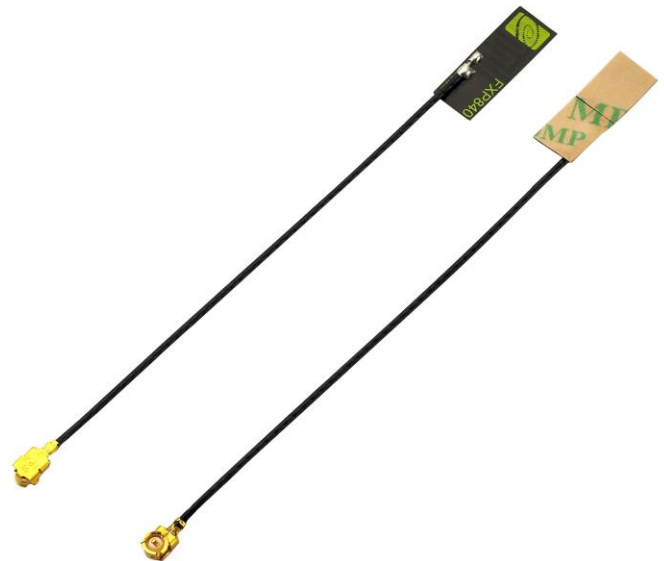


# SPECIFICATION

## PATENT PENDING

- Part No. : **FXP.840.07.0055B**
- Product Name : FXP.840 Freedom Series  
Super Small Monopole  
Dual-band 2.4 GHz /5 GHz Antenna
- Features : Flexible and Tiny - Ultra Low Profile 14mm\*5mm\*0.1mm  
2dBi Peak Gain  
Adheres directly inside of product plastic or glass housing  
Form factor and cable routing convenient for integration  
IPEX MHF1 Connector (U.FL compatible)  
55mm Ø 0.81mm mini-coaxial cable  
Customizable cable and connector  
**RoHS Compliant**



## 1. Introduction

The patent pending FXP.840 is a super small monopole ultra-low profile antenna for 2.4/5 GHz bands that includes Bluetooth and Wi-Fi dual-band application. The FXP.840 has a peak gain of 2.5dBi at 2.4GHz and efficiencies of 40%, and 2.5dBi gain and 53% efficiency at 5.8GHz.

This Taoglas patent pending antenna is unique in the market because it is made from poly-flexible material, has a tiny form factor (14mm\*5.0mm\*0.1mm) and has double-sided 3M tape for easy “peel and stick” mounting.

The cable routes conveniently directly out of the bottom of the antenna, reducing the volume the antenna takes up in the device to an absolute minimum compared to other designs. The FXP.840 is the ideal all-round antenna solution for fitting into narrow spaces and still maintaining high performance, for example on the inside top or adjacent side applied directly to the plastic housing of LCD monitors, tablets, smartphones.

The cable and connector are customizable according to customer requirements.

## 2. Specification

ELECTRICAL		
Antenna	FXP.840	
Standard	2400 MHz	5800 MHz
Operation Frequency (MHz)	2410-2490 MHz	4900~5800 MHz
Polarization	Linear	Linear
Impedance	50 Ohms	50 Ohms
Max VSWR	2:1	2.5:1
Max Return Loss (dB)	-10	-7.0
Peak Gain (dBi)	2.0	2.5
Efficiency (%)	40	53
Average Gain (dB)	-3.9	-2.8
Radiation Properties	Omni	Omni
Max Input Power	2W max	2W max

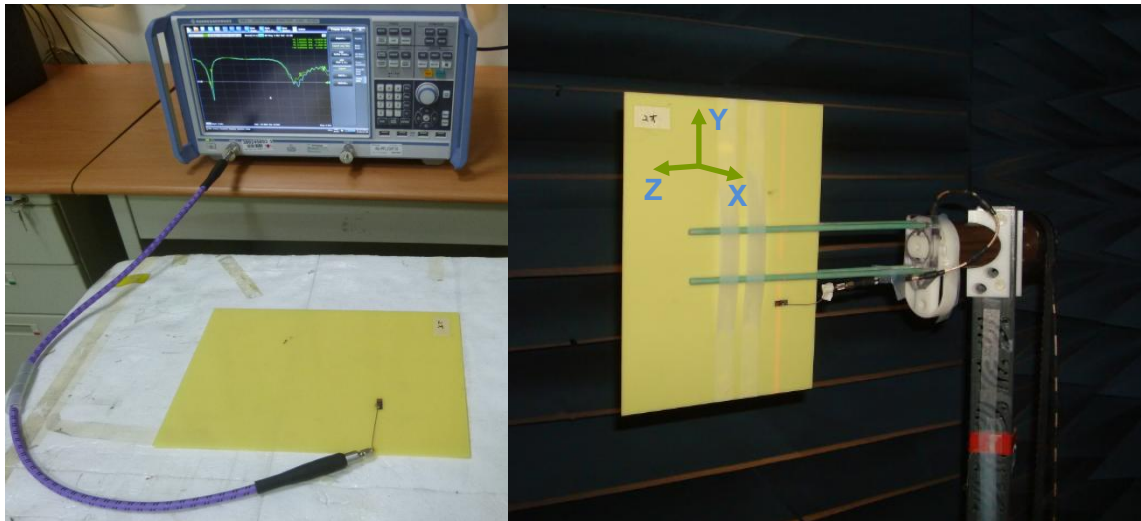
\* The FXP840 antenna performance was measured on a 30x30mm 2mm thickness ABS plastic.

MECHANICAL	
Dimensions (mm)	14 x 5.0 x 0.1
Required Space (mm)	14 x 5.0 x 0.1
Material	Polymer
Connector	IPEX MHF1

ENVIRONMENTAL	
Operation Temperature	-40°C to 85°C
Storage Temperature	-40°C to 85°C
Relative Humidity	40% to 95%
RoHs Compliant	Yes

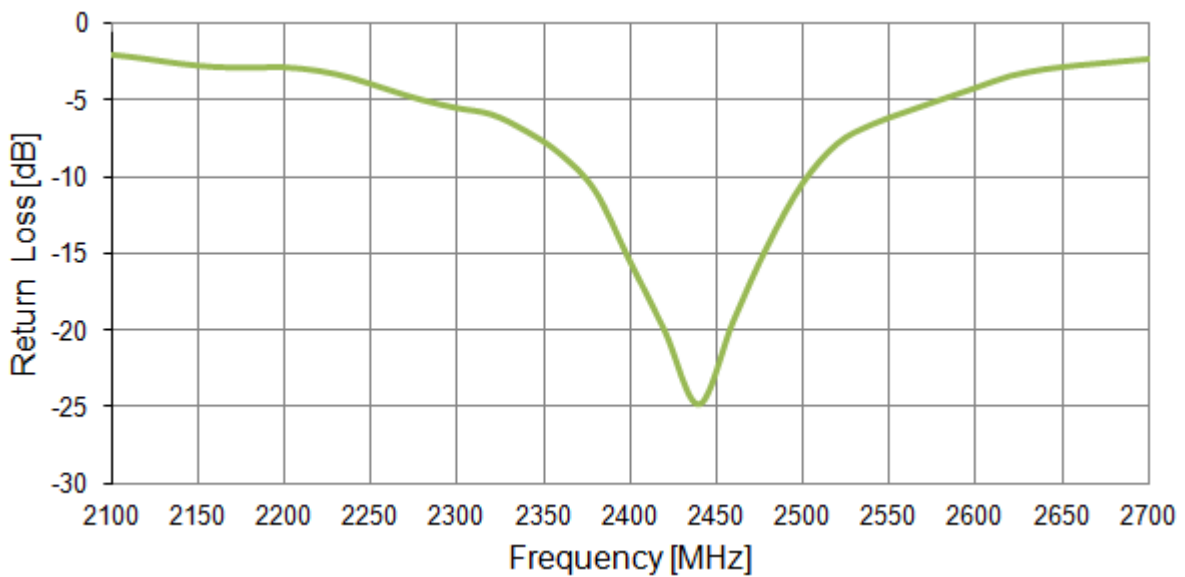
### 3. Antenna Characteristics

#### 3.1 Test set-up

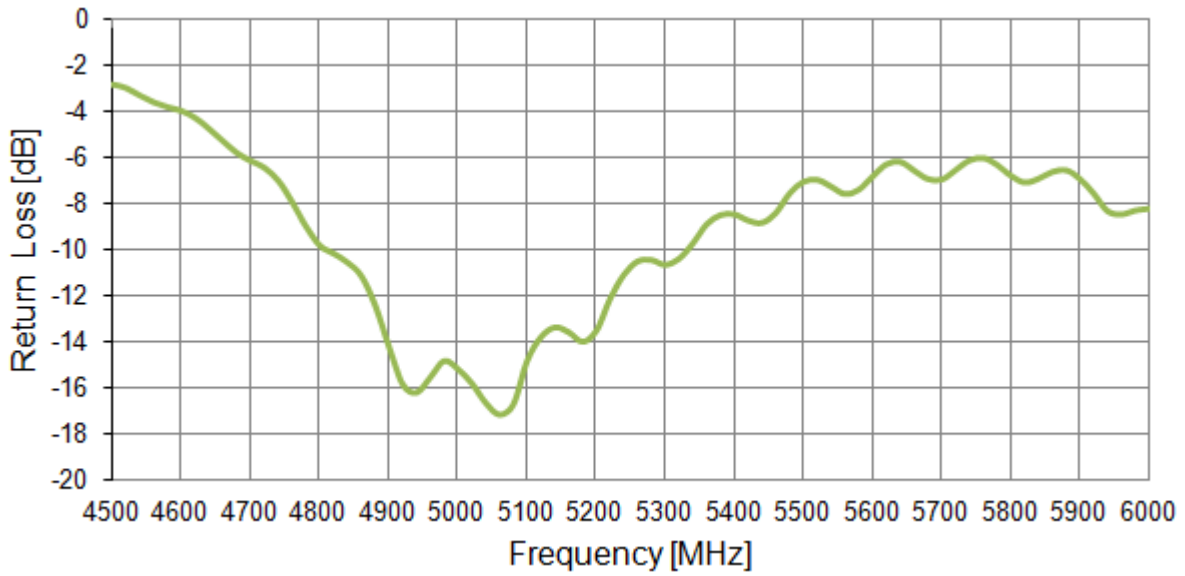


**Figure 1.** Impedance measurements (left side) and peak gain, efficiency and radiation pattern measurements (right side).

#### 3.2 Return Loss

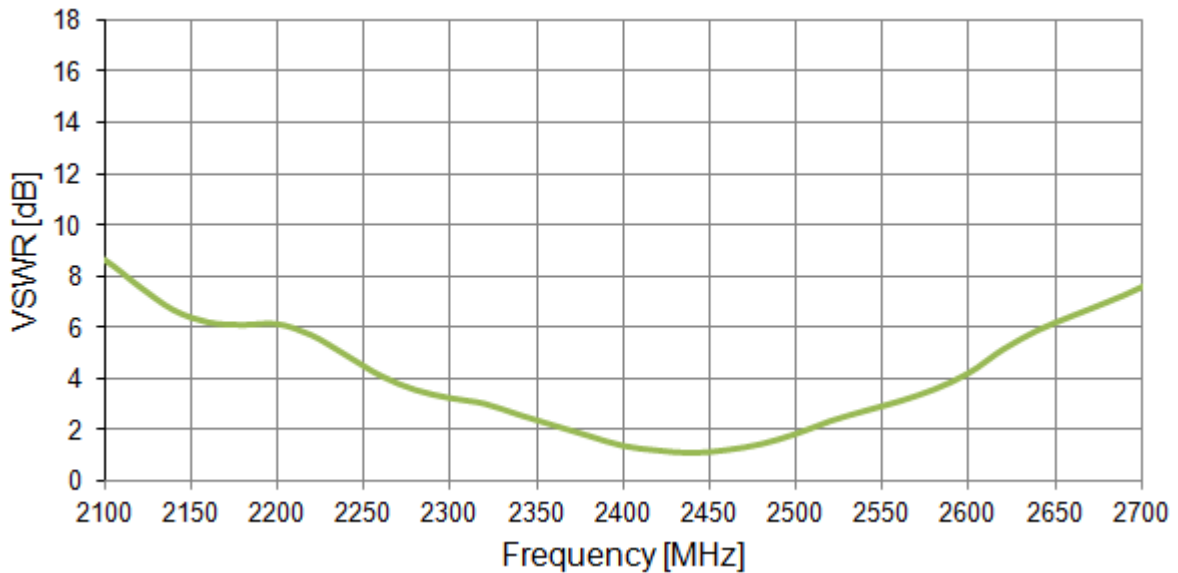


**Figure 2.** Return loss of the FXP840 antenna from 2100 MHz to 2700 MHz.

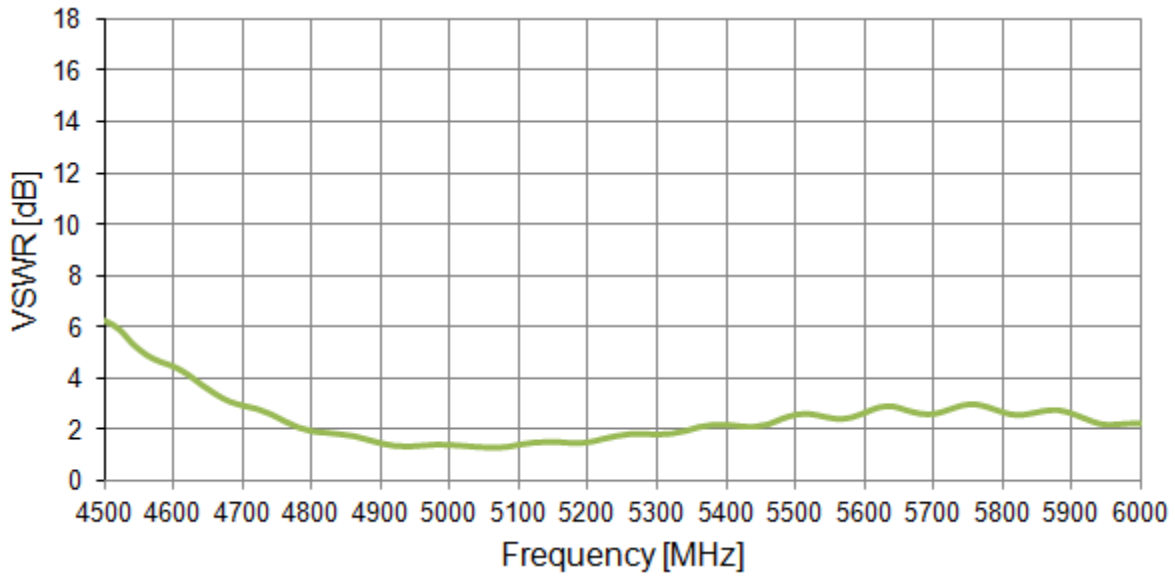


**Figure 3.** Return loss of the FXP840 antenna from 4500 MHz to 6000 MHz.

### 3.3 VSWR

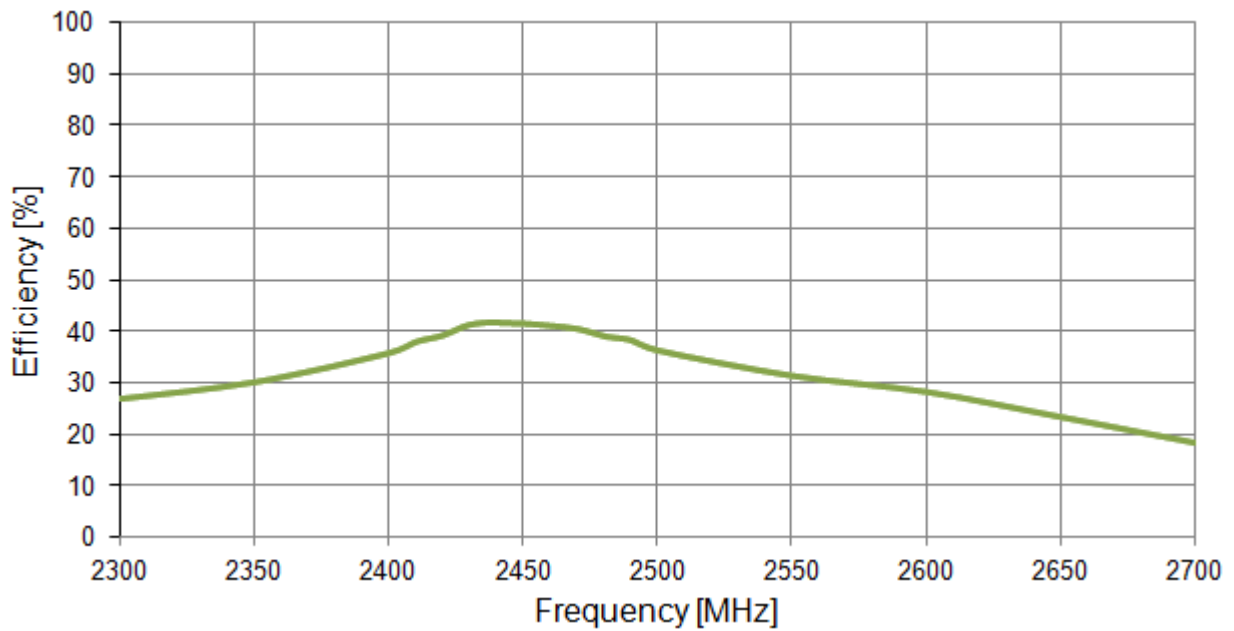


**Figure 4.** VSWR of the FXP840 antenna from 2100 MHz to 2700 MHz.

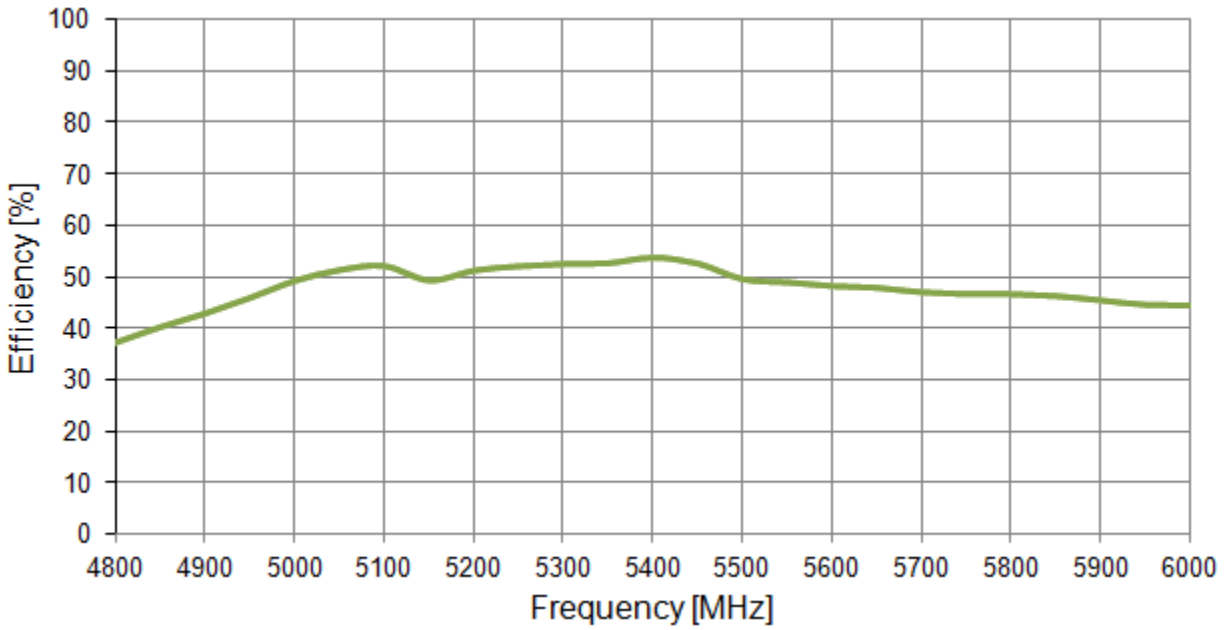


**Figure 5.** VSWR of the FXP840 antenna from 4500 MHz to 6000 MHz

### 3.4 Efficiency

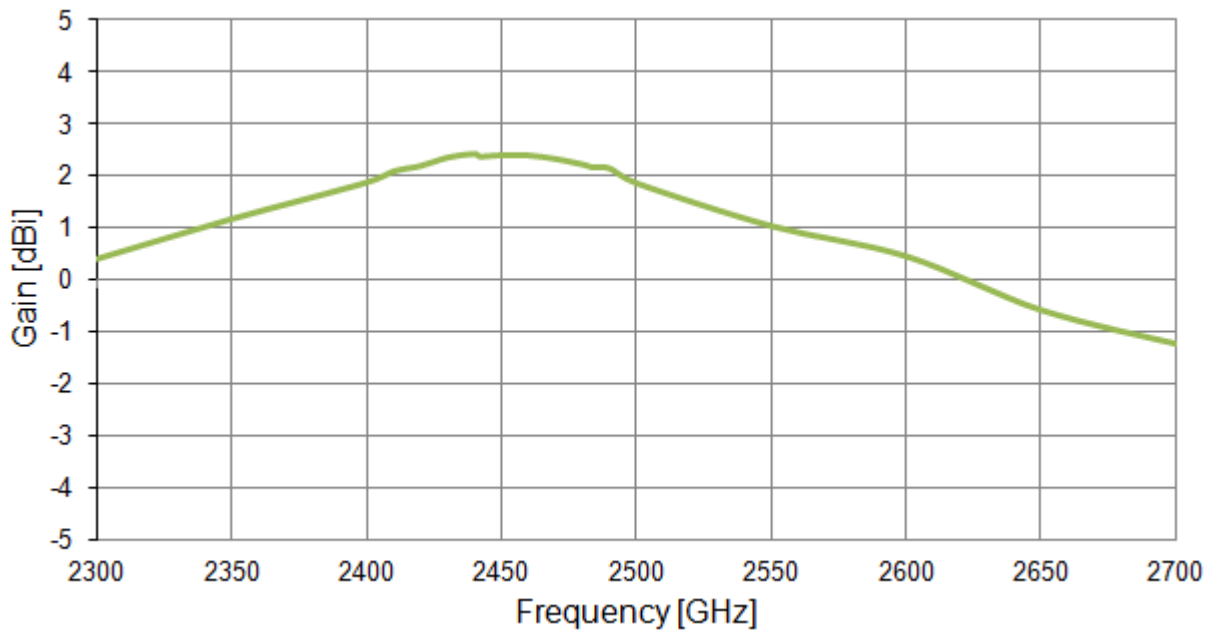


**Figure 6.** Efficiency of the FXP840 antenna from 2300 MHz to 2700 MHz.

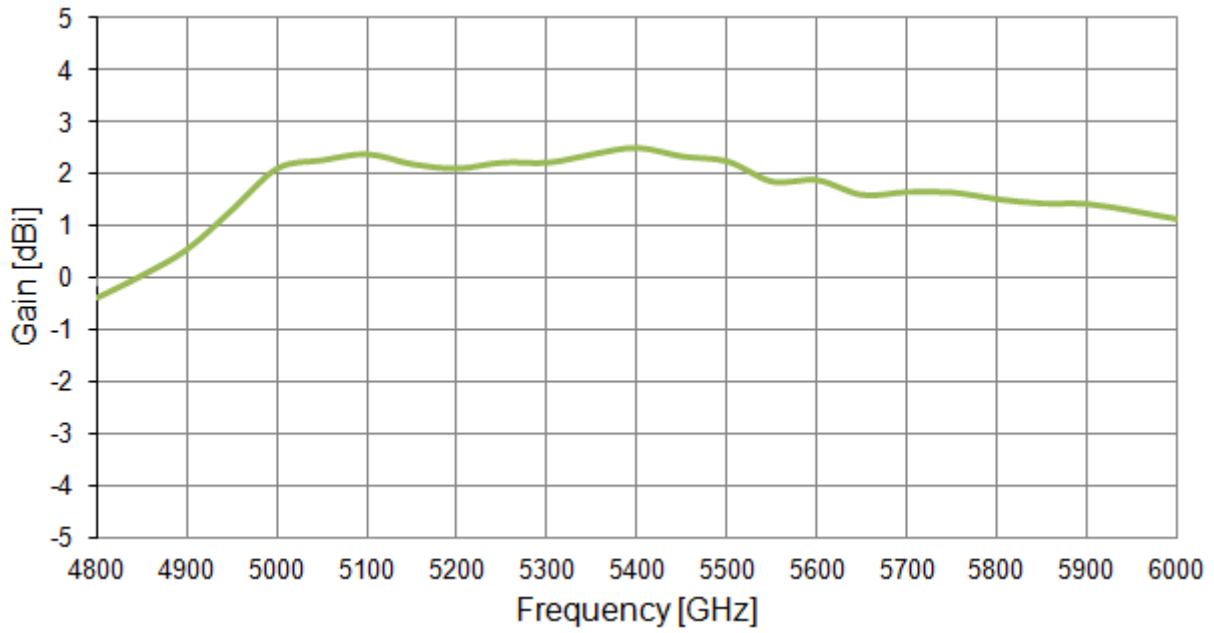


**Figure 7.** Efficiency of the FXP840 antenna from 4800 MHz to 6000 MHz.

### 3.5 Peak Gain

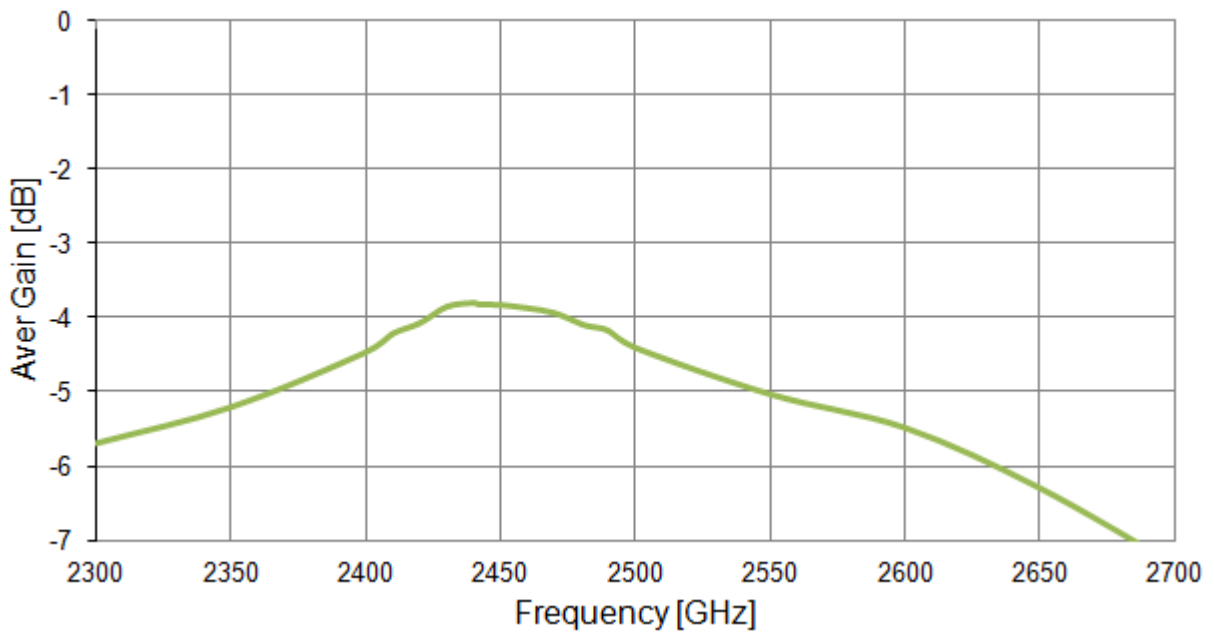


**Figure 8** Peak Gain of the FXP840 antenna from 2300 MHz to 2700 MHz.



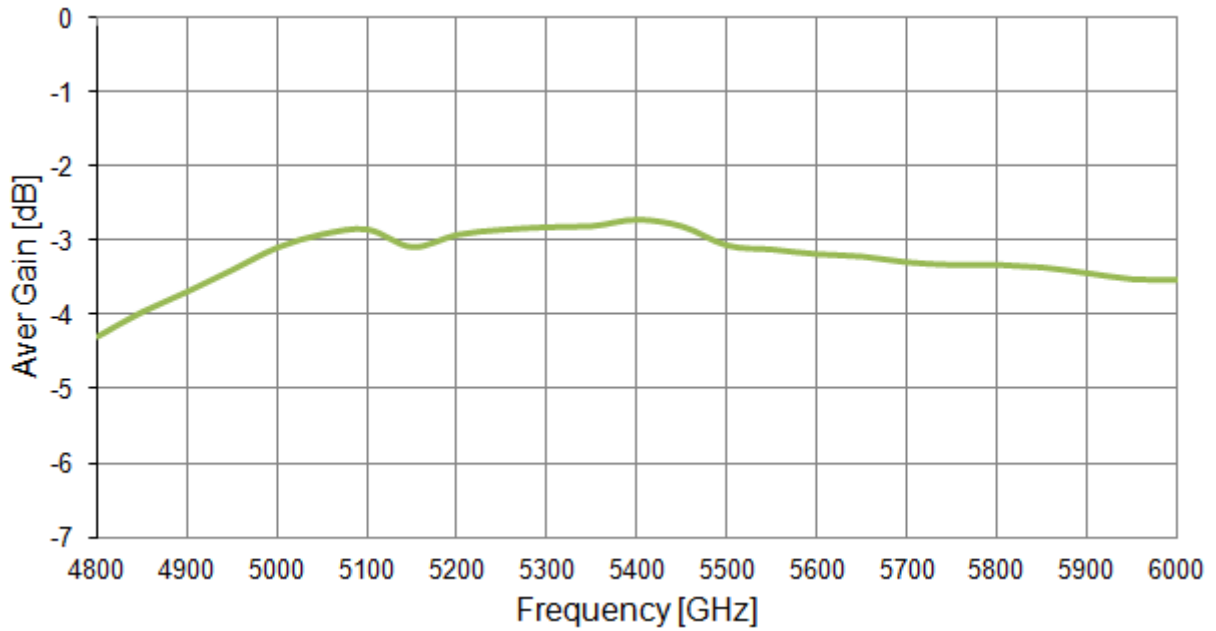
**Figure 9.** Peak Gain of the FXP840 antenna from 4800 MHz to 6000 MHz.

### 3.6 Average Gain



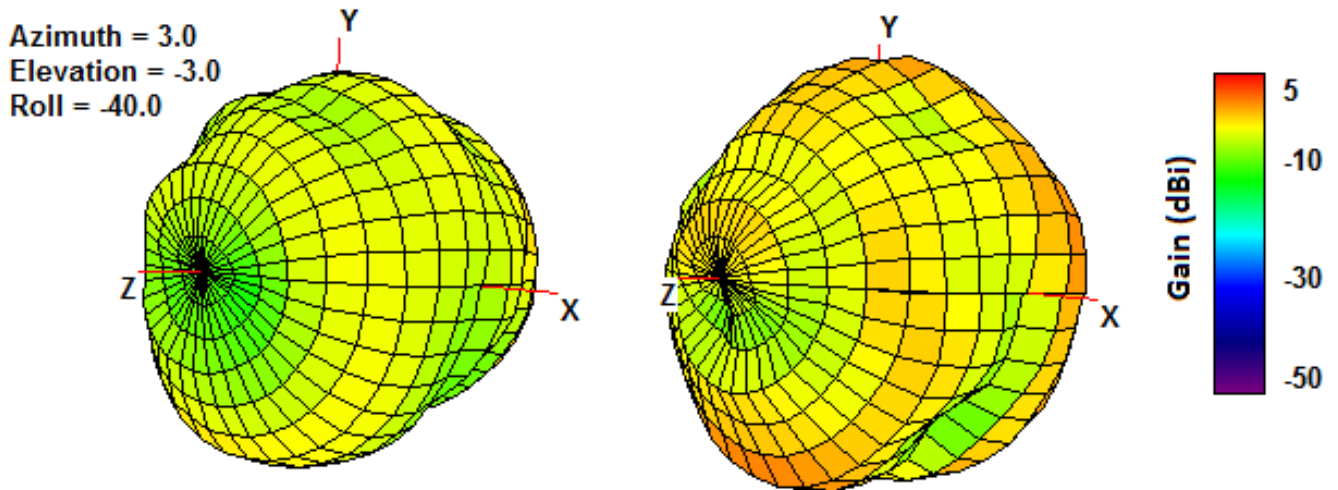
**Figure 10.** Average Gain of the FXP840 antenna from 2300 MHz to 2700 MHz.





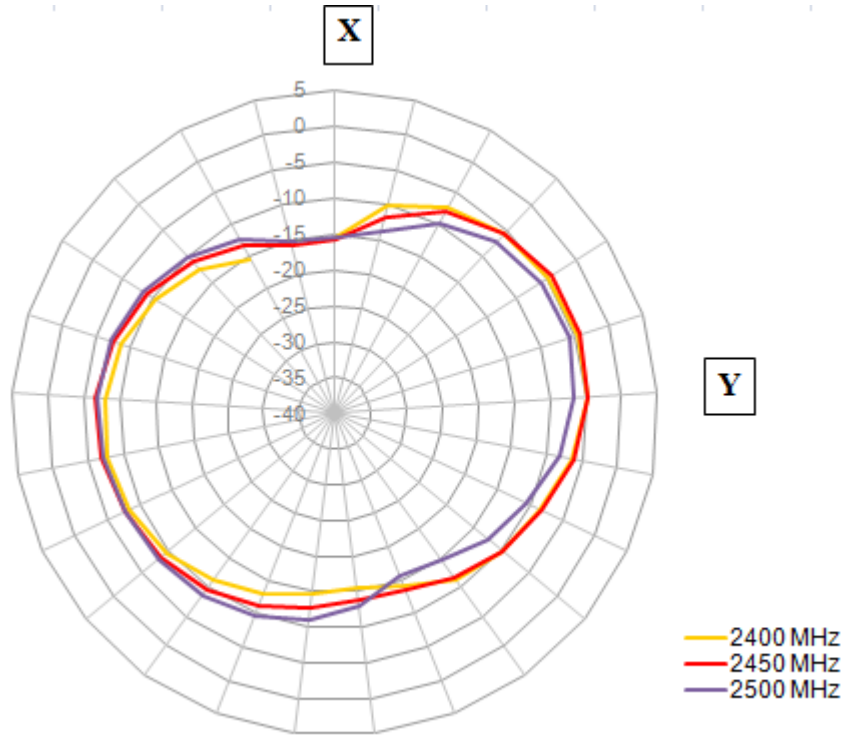
**Figure 11** Average Gain of the FXP840 antenna from 4800 MHz to 6000 MHz.

### 3.7 3D radiation patterns

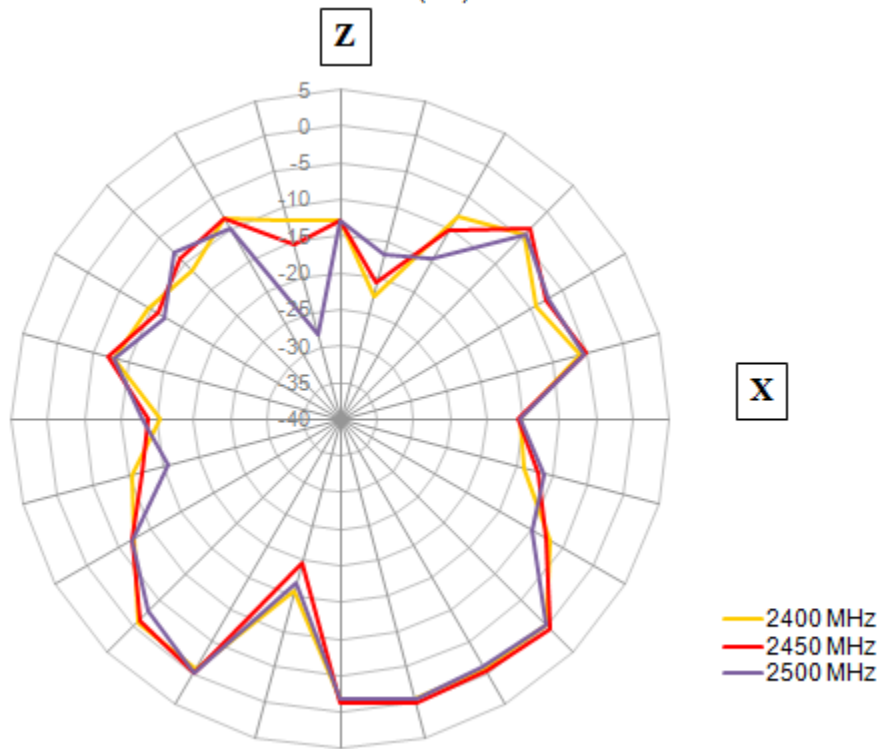


**Figure 12.** 3D Radiation Pattern at 2450 MHz (left side), Radiation Pattern at 5000 MHz (right side) of the FXP840 Antenna.

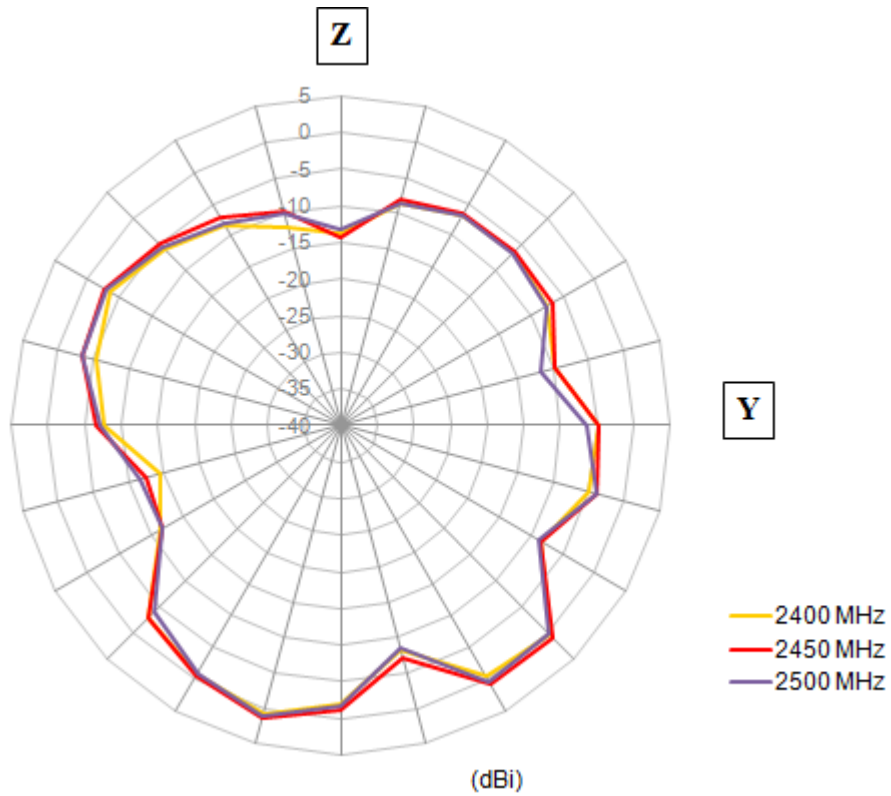
### 3.8 2D radiation patterns



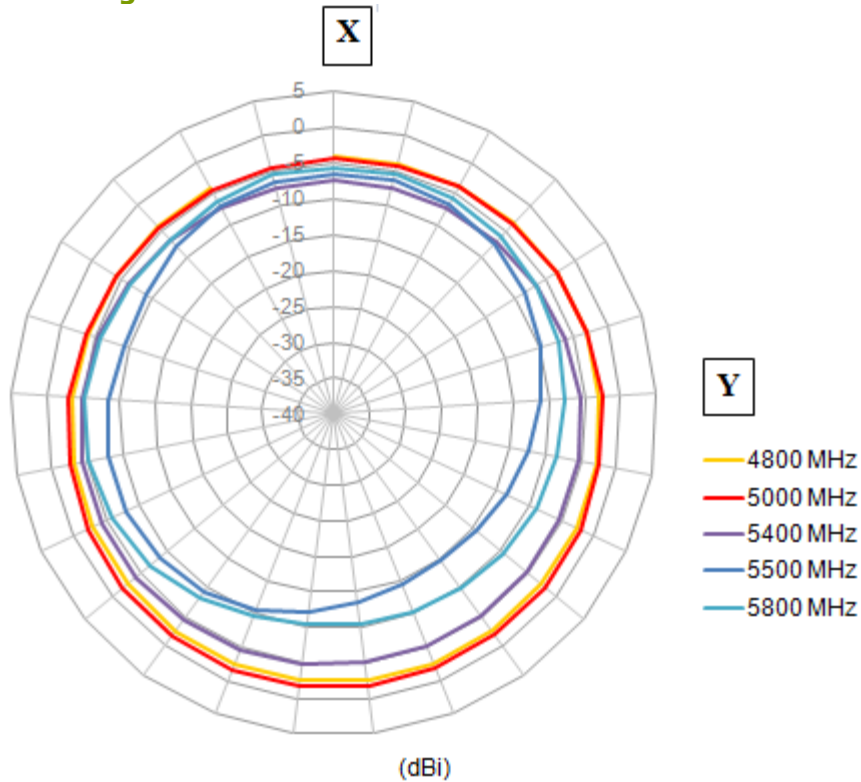
(dBi)

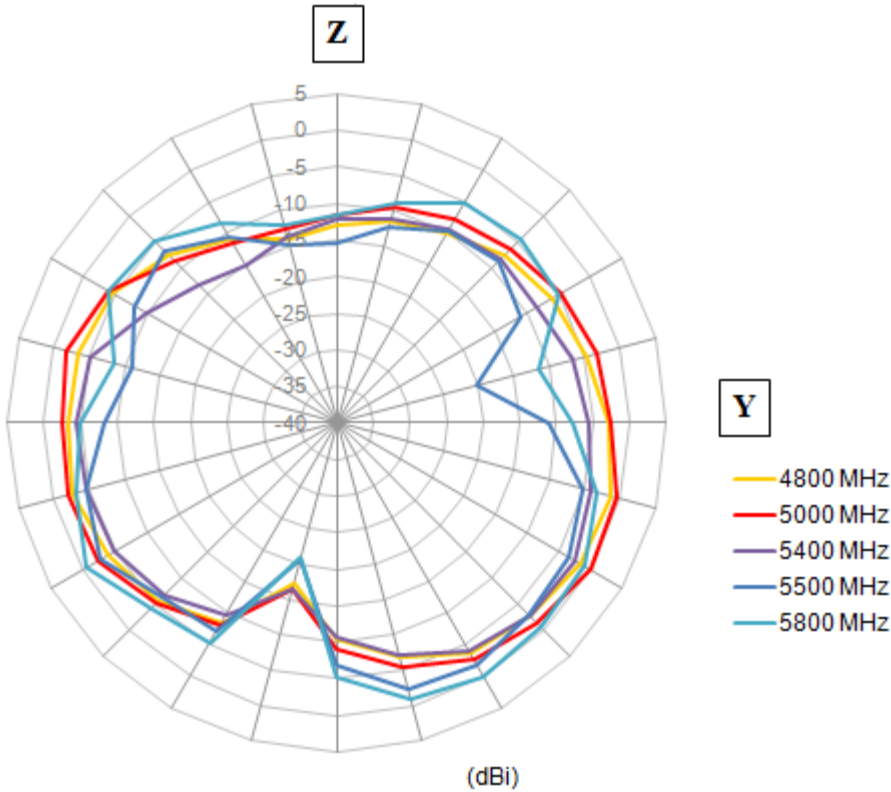
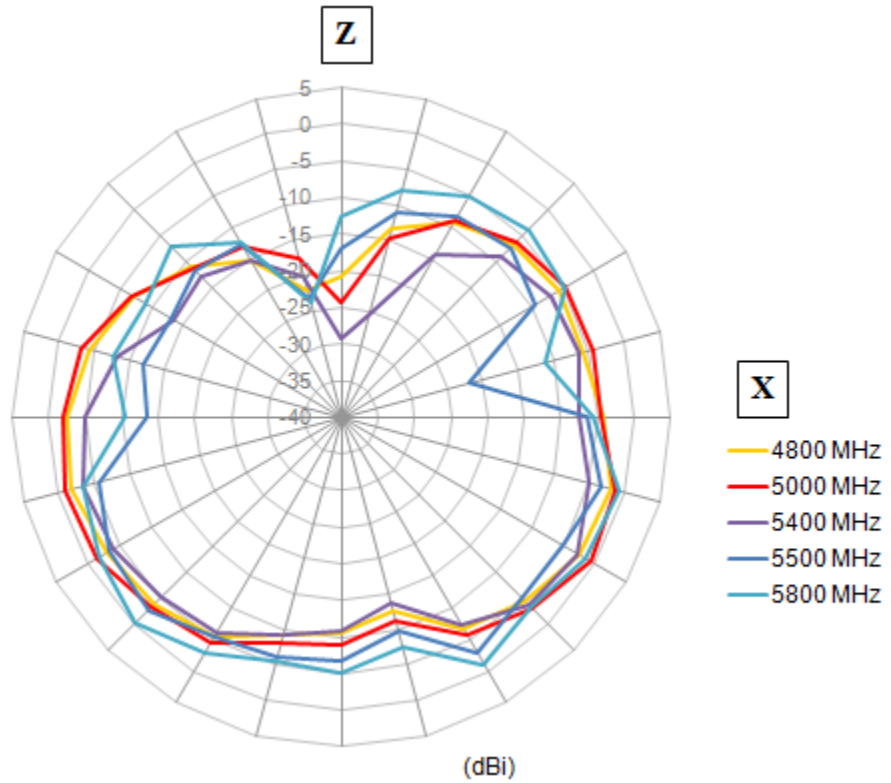


(dBi)



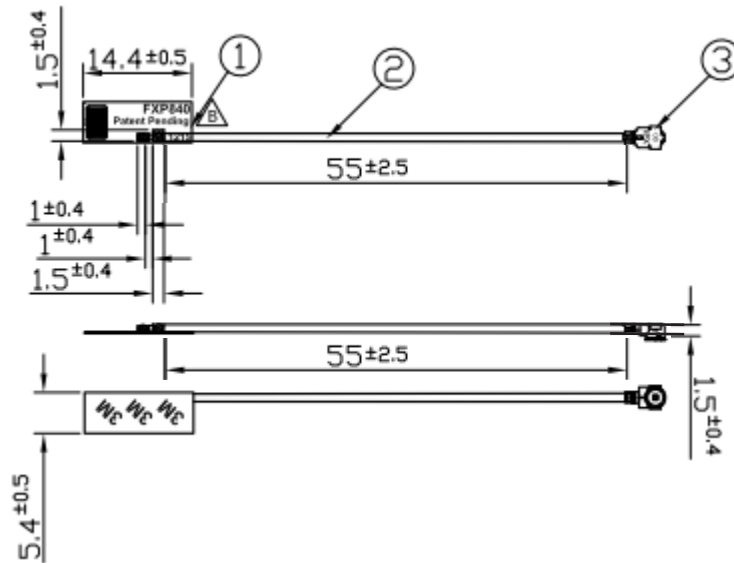
**Figure 13.** 2D Radiation Pattern at 2400MHz band





**Figure 14.** 2D Radiation Pattern at 5800MHz band

## 4. Antenna Drawing



	Name
①	FXP840 FPCB
②	0.81 Coaxial Cable
③	IPEX MHF1

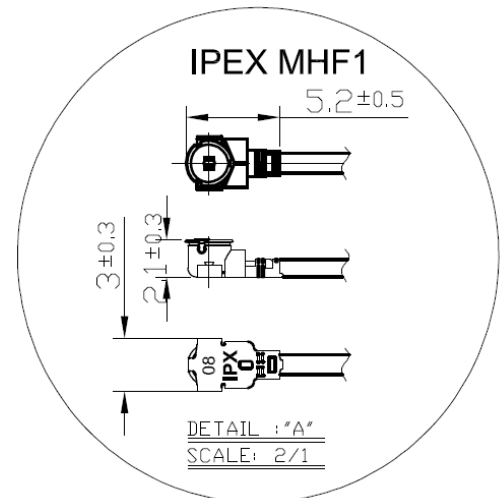
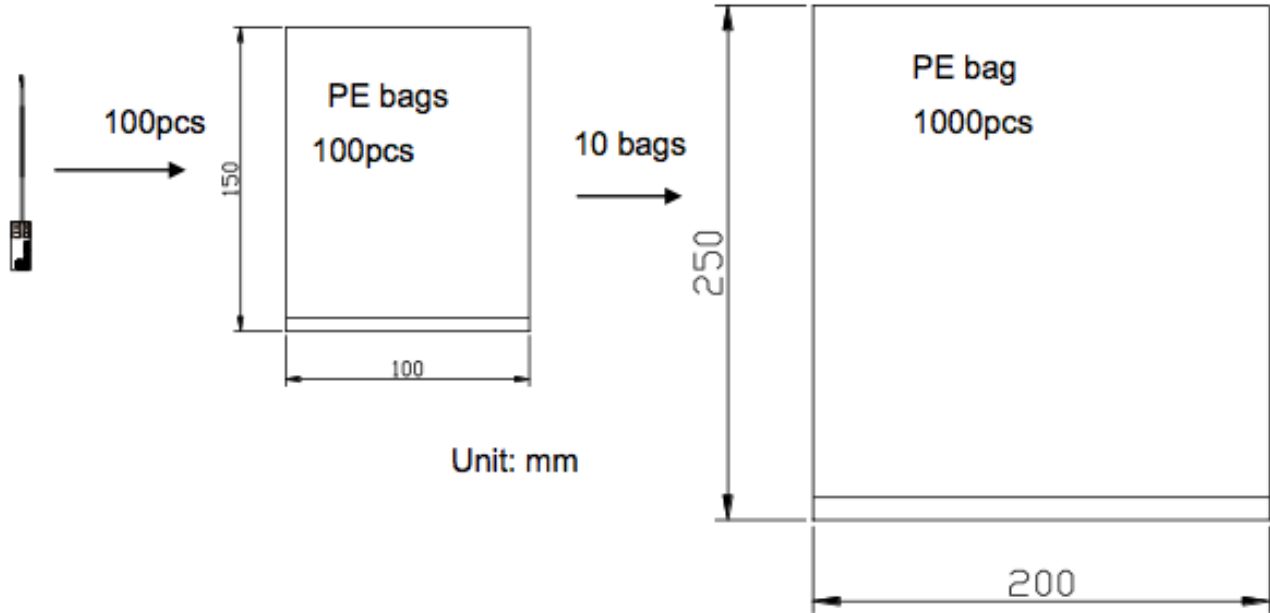


Figure 15. Antenna drawing

## 5. Packaging



**Figure 16.** Package of the FXP840 Antenna.