

30V N-Channel Enhancement Mode MOSFET

MTN007N03LS3

BV _{DSS}	30V
I _D	780mA
R _{DS(on)} @V _{GS} =4.5V, I _D =400mA	310mΩ (typ)
R _{DS(on)} @V _{GS} =2.5V, I _D =250mA	440mΩ (typ)
R _{DS(on)} @V _{GS} =1.8V, I _D =150mA	580mΩ (typ)

Features

- Simple drive requirement
- Small package outline
- Pb-free lead plating and halogen-free package

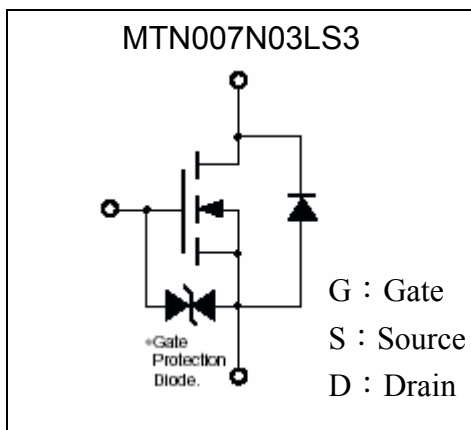
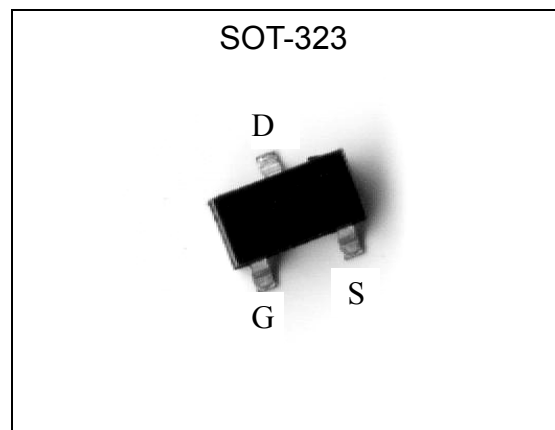
Symbol

Outline

Ordering Information

Device	Package	Shipping
MTN007N03LS3-0-T1-G	SOT-323 (Pb-free lead plating and halogen-free package)	3000 pcs / Tape & Reel



Absolute Maximum Ratings (Ta=25°C)

Parameter	Symbol	Limits	Unit
Drain-Source Voltage	V _{DS}	30	V
Gate-Source Voltage	V _{GS}	±8	
Continuous Drain Current @ TA=25°C (Note 3)	I _D	780	mA
Continuous Drain Current @ TA=70°C (Note 3)		620	
Pulsed Drain Current (Notes 1, 2)	I _{DM}	3.5	A
Maximum Power Dissipation@ TA=25°C	P _D	0.35	W
Linear Derating Factor		0.003	
ESD susceptibility		1000 (Note 4)	V
Operating Junction and Storage Temperature	T _j , T _{stg}	-55~+150	°C

- Note : 1. Pulse width limited by maximum junction temperature.
 2. Pulse width ≤ 300μs, duty cycle ≤ 2%.
 3. Surface mounted on 1 in² copper pad of FR-4 board, t ≤ 10 seconds.
 4. Human body model, 1.5kΩ in series with 100pF.

Thermal Performance

Parameter	Symbol	Limit	Unit
Thermal Resistance, Junction-to-Ambient(PCB mounted) (Note)	R _{th,ja}	360	°C/W

Note : Surface mounted on 1 in² copper pad of FR-4 board, t ≤ 10 seconds.

Electrical Characteristics (Tj=25°C, unless otherwise noted)

Symbol	Min.	Typ.	Max.	Unit	Test Conditions
Static					
BV _{DSS}	30	-	-	V	V _{GS} =0, I _D =250μA
ΔBV _{DSS} /ΔT _j	-	0.02	-	V/°C	Reference to 25°C, I _D =250μA
V _{GS(th)}	0.5	0.75	1.0	V	V _{DS} =V _{GS} , I _D =250μA
I _{GSS}	-	-	±5	μA	V _{GS} =±8V, V _{DS} =0
I _{DSS}	-	-	1		V _{DS} =30V, V _{GS} =0
	-	-	10		V _{DS} =24V, V _{GS} =0 (T _j =70°C)
*R _{DS(ON)}	-	310	400	mΩ	V _{GS} =4.5V, I _D =400mA
	-	440	600		V _{GS} =2.5V, I _D =250mA
	-	580	750		V _{GS} =1.8V, I _D =150mA
*G _{FS}	-	1.2	-	S	V _{DS} =5V, I _D =400mA
Dynamic					
C _{iss}	-	58	-	pF	V _{DS} =15V, V _{GS} =0, f=1MHz
C _{oss}	-	10	-		
C _{rss}	-	6	-		



$t_{d(ON)}$	-	6	-	ns	$V_{DS}=15V, I_D=400mA, V_{GS}=4.5V,$ $R_G=6\Omega$
t_r	-	7	-		
$t_{d(OFF)}$	-	14	-		
t_f	-	4	-		
Q_g	-	1.4	-	nC	$V_{DS}=24V, I_D=780mA, V_{GS}=4.5V$
Q_{gs}	-	0.2	-		
Q_{gd}	-	0.5	-		
Source-Drain Diode					
$*V_{SD}$	-	0.74	1.2	V	$V_{GS}=0V, I_S=100mA$

*Pulse Test : Pulse Width $\leq 300\mu s$, Duty Cycle $\leq 2\%$

Typical Characteristics

Typical Output Characteristics

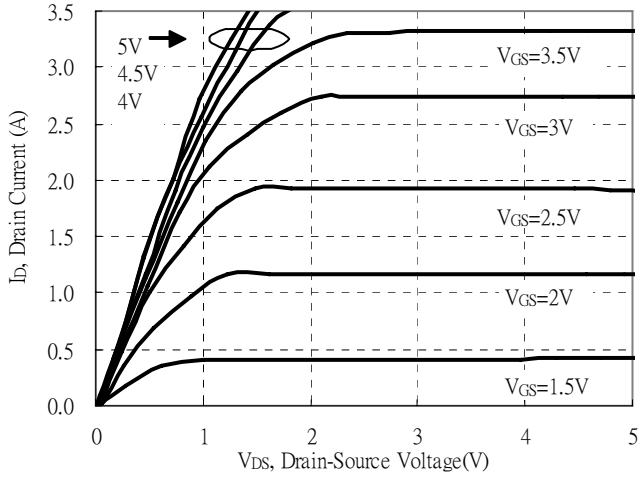

Breakdown Voltage vs Ambient Temperature

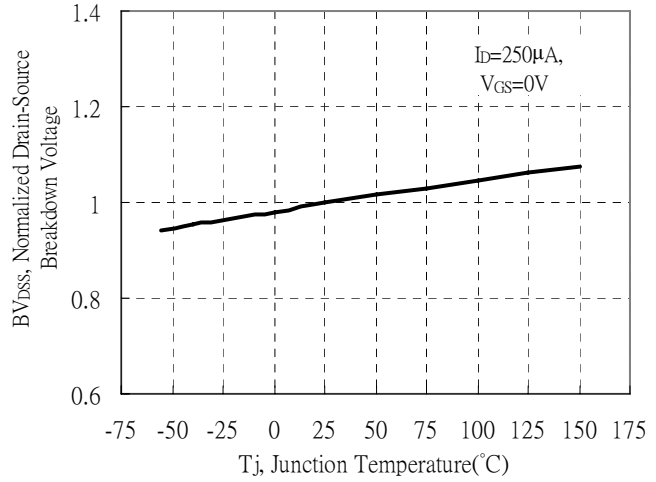

Static Drain-Source On-State resistance vs Drain Current

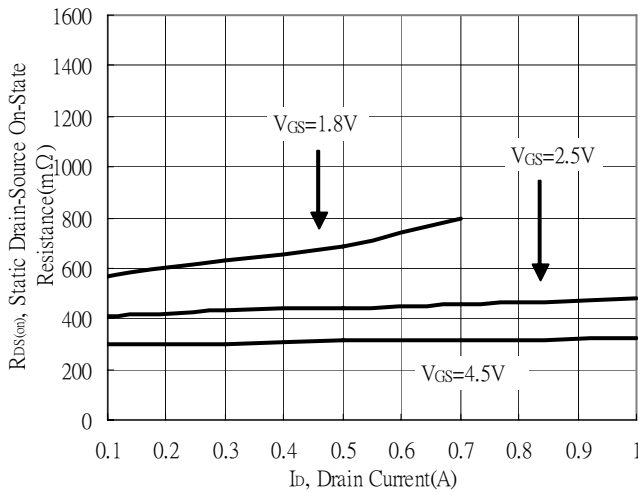

Reverse Drain Current vs Source-Drain Voltage

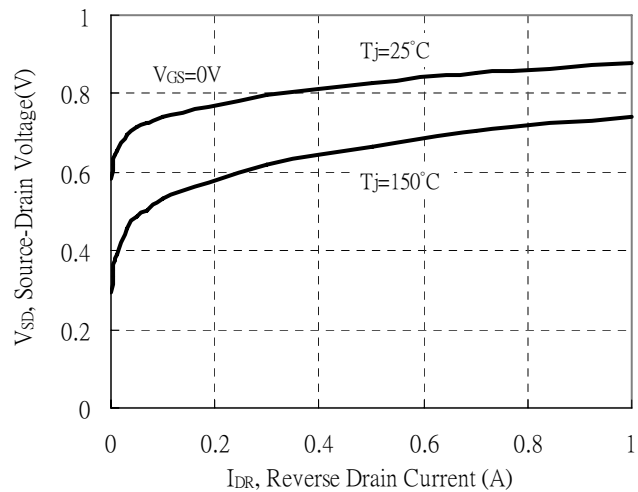

Static Drain-Source On-State Resistance vs Gate-Source Voltage

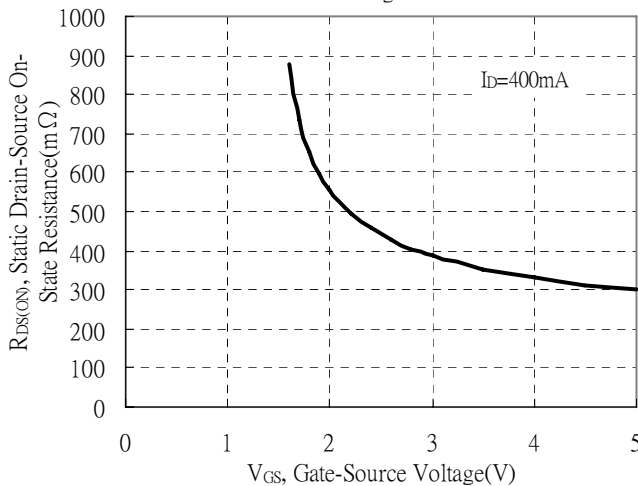

Drain-Source On-State Resistance vs Junction Temperature

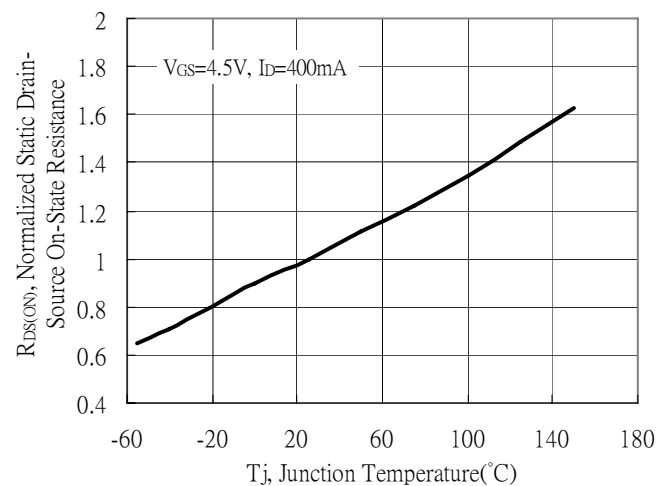



Typical Characteristics(Cont.)

Capacitance vs Drain-to-Source Voltage

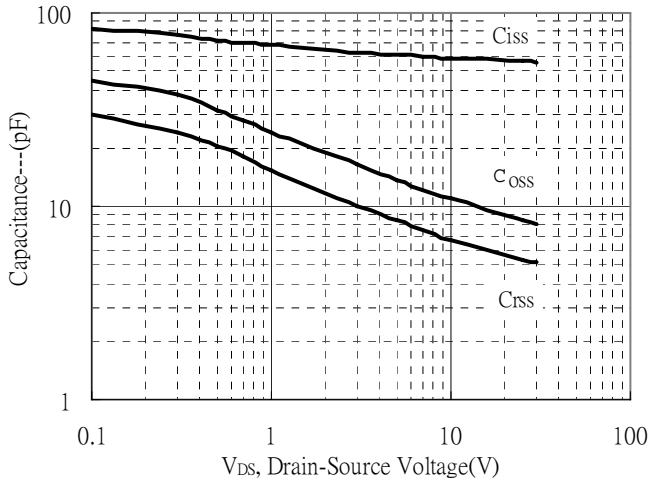

Threshold Voltage vs Junction Temperature

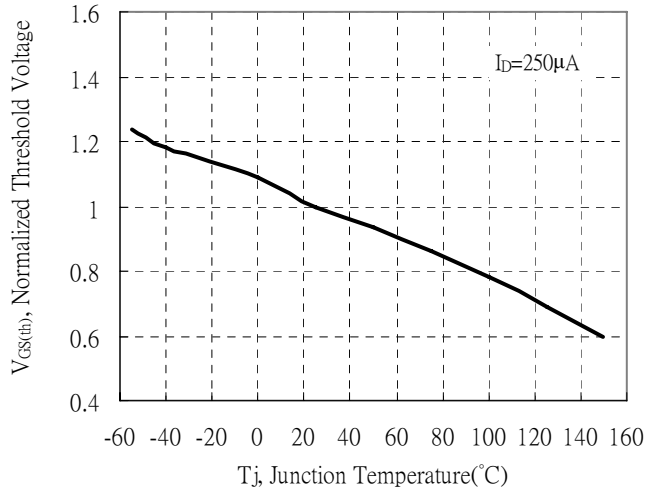

Single Pulse Power Rating, Junction to Ambient
 (Note on page 2)

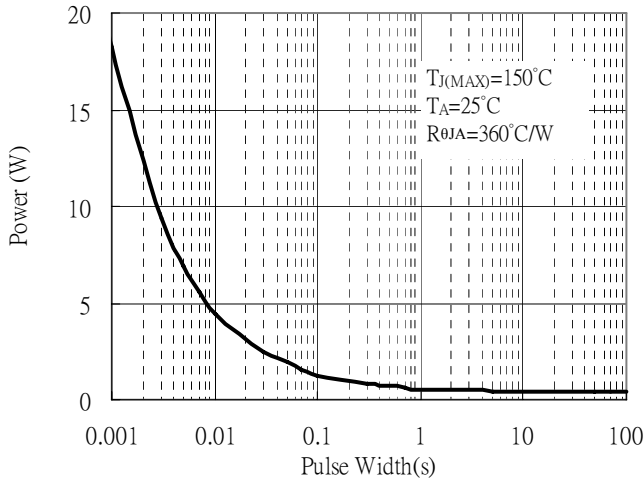

Gate Charge Characteristics

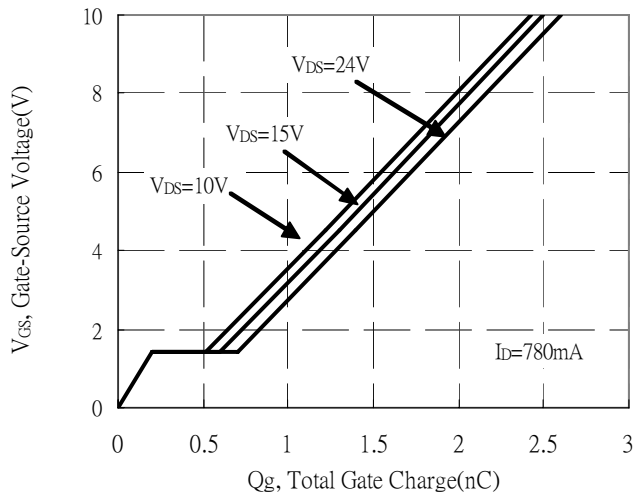

Maximum Safe Operating Area

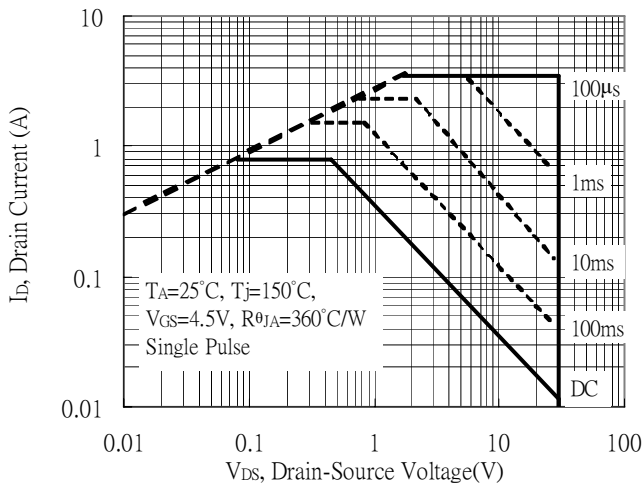

Maximum Drain Current vs Junction Temperature

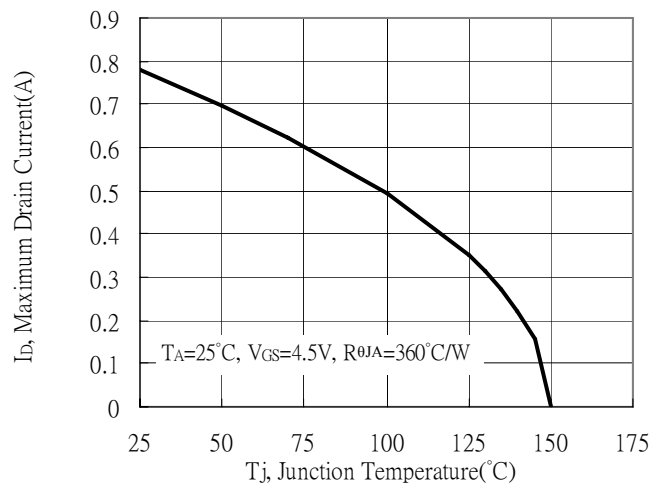

Typical Characteristics(Cont.)

Typical Transfer Characteristics

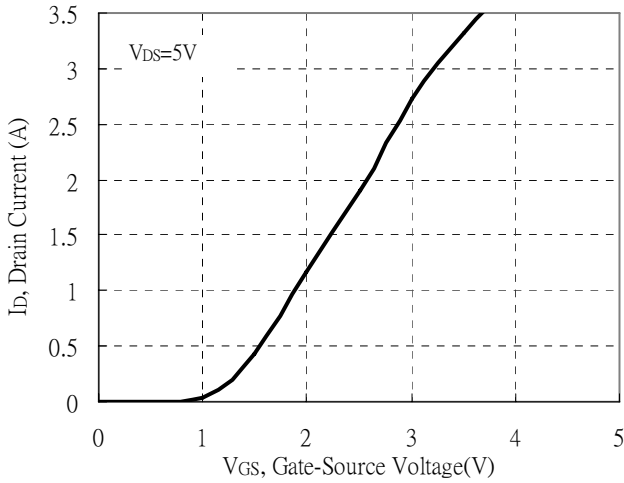

Power Derating Curve

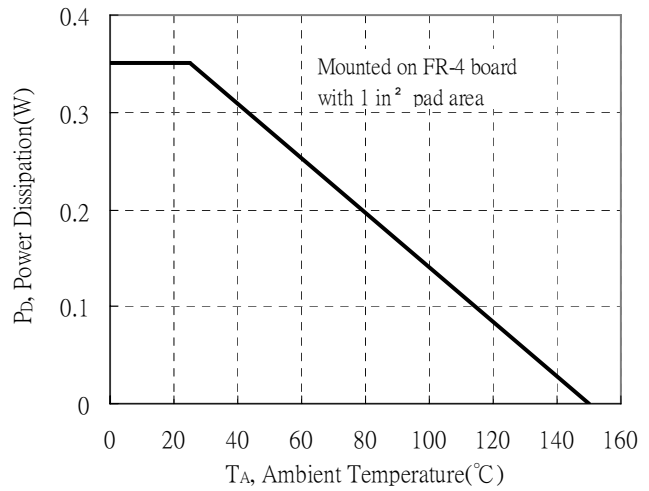

Transient Thermal Response Curves

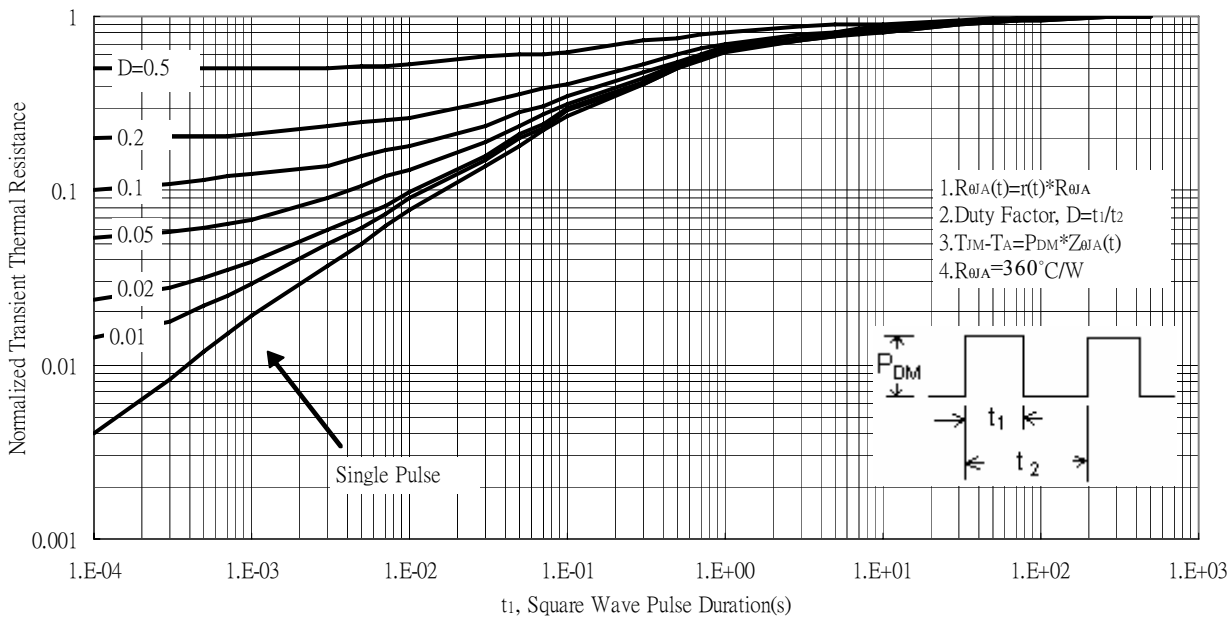

Forward Transfer Admittance vs Drain Current

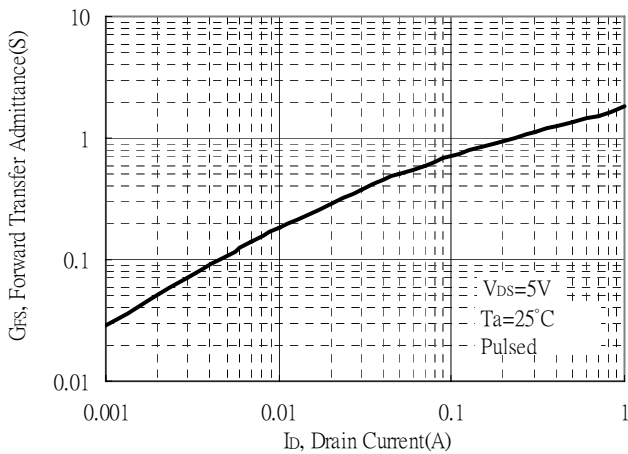

Reel Dimension

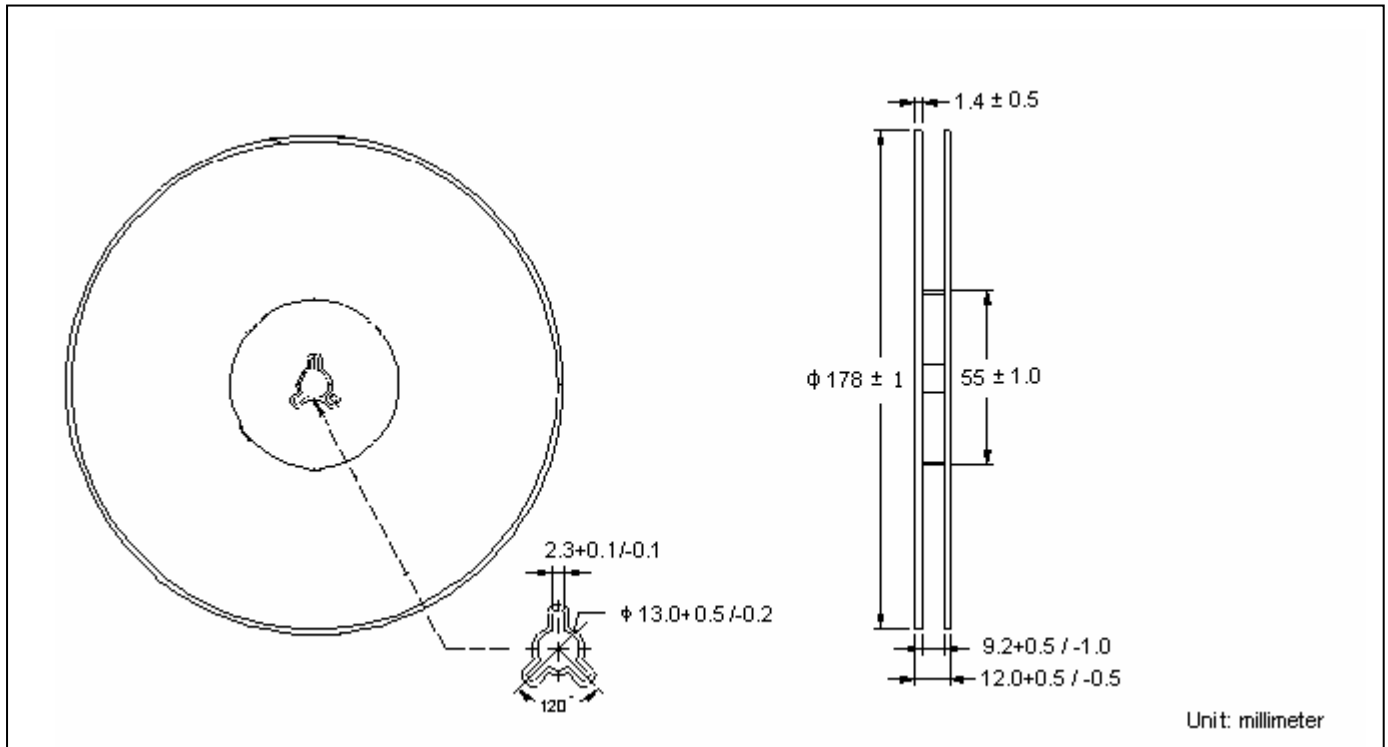

Carrier Tape Dimension

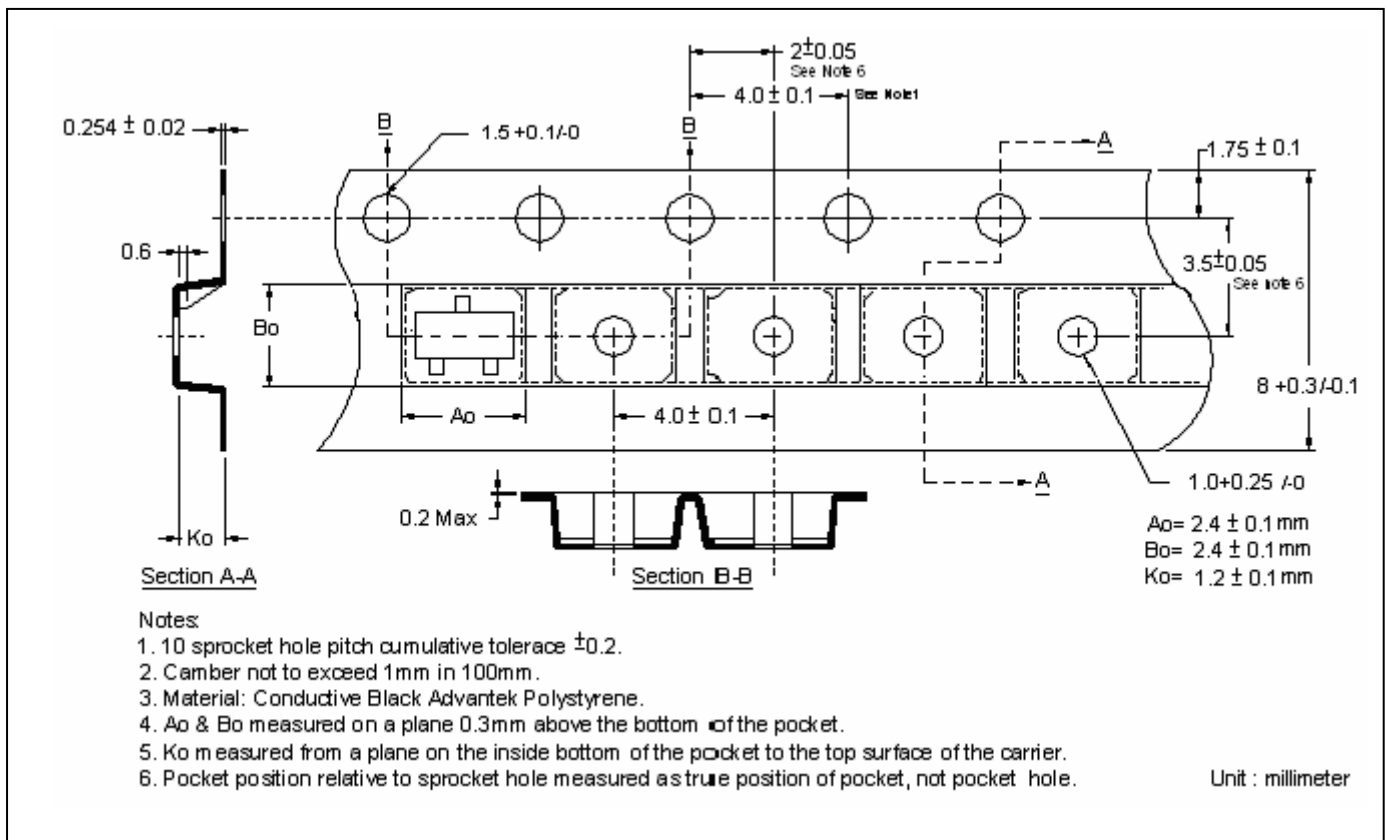

Recommended wave soldering condition

Product	Peak Temperature	Soldering Time
Pb-free devices	260 +0/-5 °C	5 +1/-1 seconds

Recommended temperature profile for IR reflow

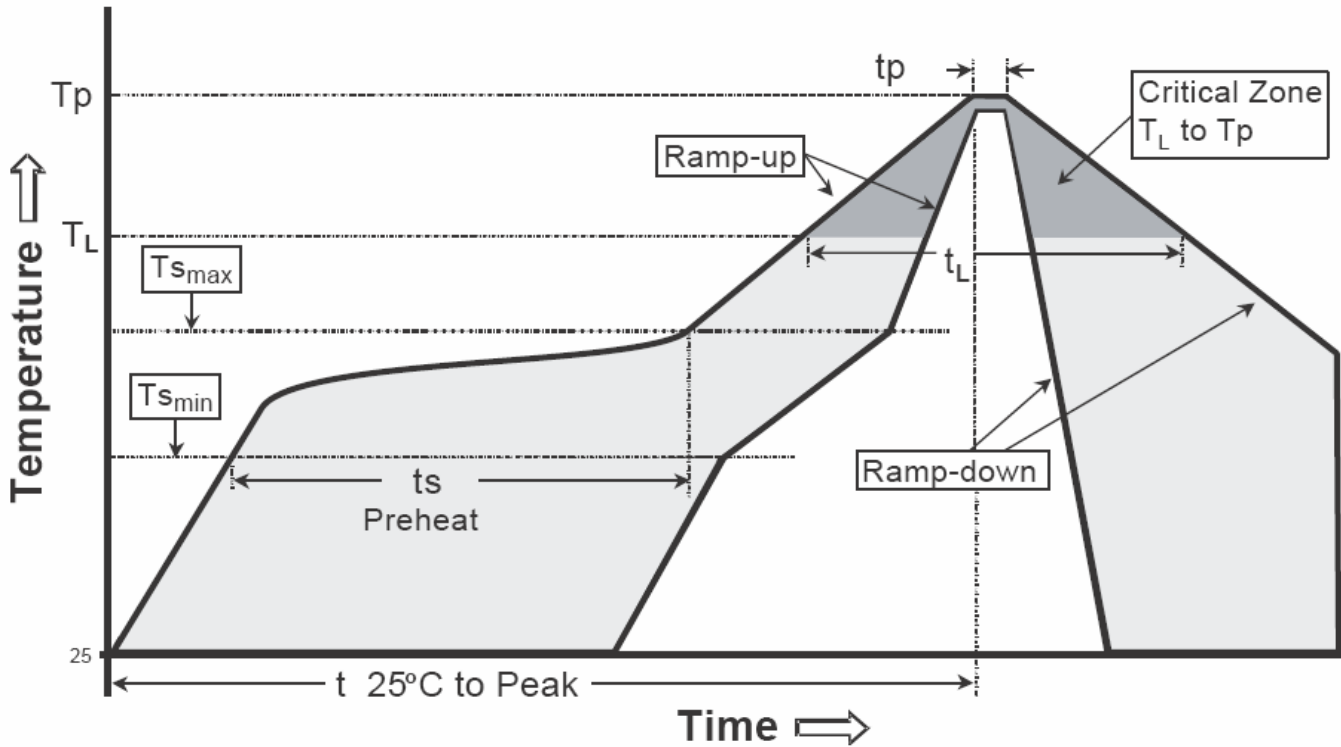

Profile feature	Sn-Pb eutectic Assembly	Pb-free Assembly
Average ramp-up rate (Tsmax to Tp)	3°C/second max.	3°C/second max.
Preheat -Temperature Min(Ts min) -Temperature Max(Ts max) -Time(ts min to ts max)	100°C 150°C 60-120 seconds	150°C 200°C 60-180 seconds
Time maintained above: -Temperature (TL) - Time (tL)	183°C 60-150 seconds	217°C 60-150 seconds
Peak Temperature(TP)	240 +0/-5 °C	260 +0/-5 °C
Time within 5°C of actual peak temperature(tp)	10-30 seconds	20-40 seconds
Ramp down rate	6°C/second max.	6°C/second max.
Time 25 °C to peak temperature	6 minutes max.	8 minutes max.

Note : All temperatures refer to topside of the package, measured on the package body surface.

SOT-323 Dimension

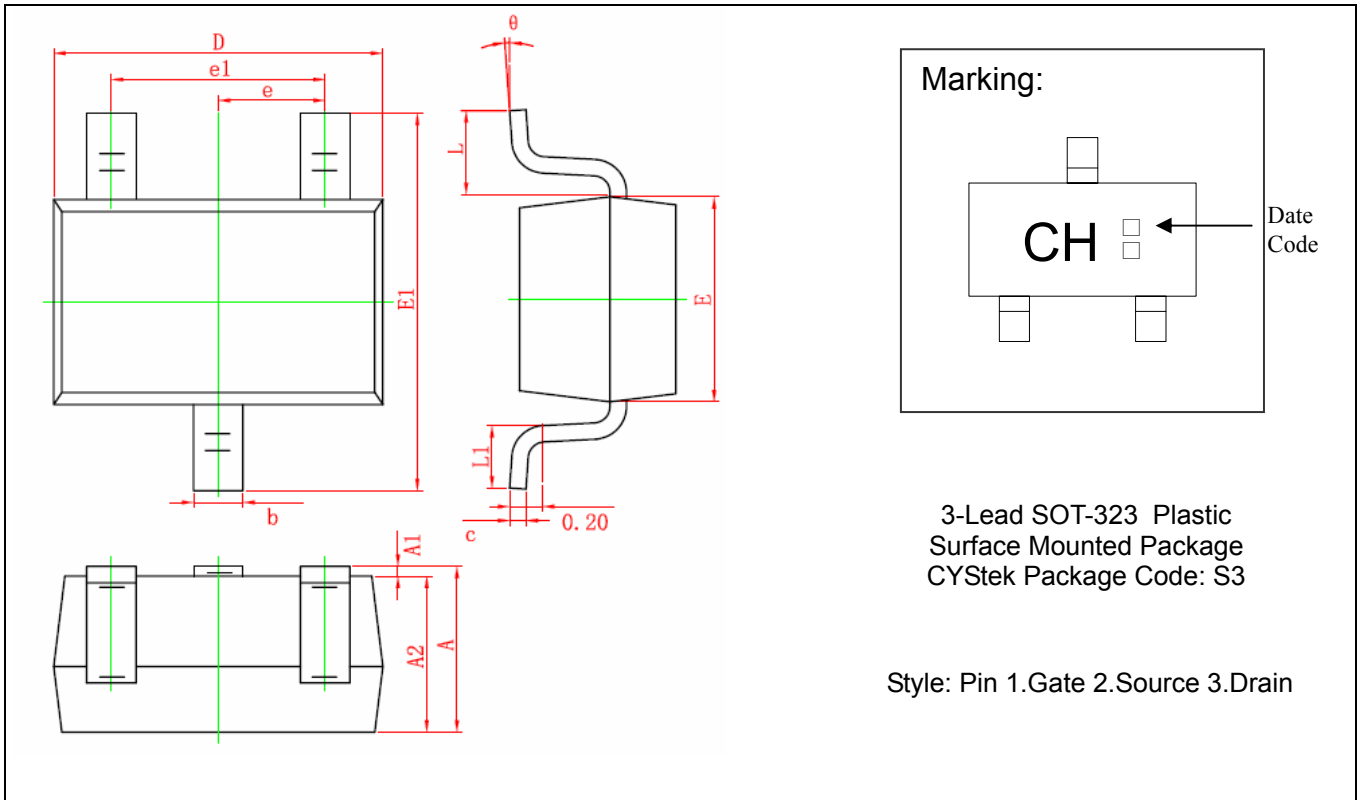

DIM	Millimeters		Inches		DIM	Millimeters		Inches	
	Min.	Max.	Min.	Max.		Min.	Max.	Min.	Max.
A	0.900	1.100	0.035	0.043	E1	2.150	2.450	0.085	0.096
A1	0.000	0.100	0.000	0.004	e	0.650 TYP		0.026	TYP
A2	0.900	1.000	0.035	0.039	e1	1.200	1.400	0.047	0.055
b	0.200	0.400	0.008	0.016	L	0.525 REF		0.021	REF
c	0.080	0.150	0.003	0.006	L1	0.260	0.460	0.010	0.018
D	2.000	2.200	0.079	0.087	θ	0°	8°	0°	8°
E	1.150	1.350	0.045	0.053					

Notes: 1.Controlling dimension: millimeters.
 2.Maximum lead thickness includes lead finish thickness, and minimum lead thickness is the minimum thickness of base material.
 3.If there is any question with packing specification or packing method, please contact your local CYStek sales office.

Material:

- Lead: Pure tin plated.
- Mold Compound: Epoxy resin family, flammability solid burning class: UL94V-0.

Important Notice:

- All rights are reserved. Reproduction in whole or in part is prohibited without the prior written approval of CYStek.
- CYStek reserves the right to make changes to its products without notice.
- CYStek **semiconductor products are not warranted to be suitable for use in Life-Support Applications, or systems.**
- CYStek assumes no liability for any consequence of customer product design, infringement of patents, or application assistance.