

## Micropower Single Supply Rail-to-Rail Input-Output Precision Op Amp

The EL8178 is a micropower precision operational amplifier optimized for single supply operation at 5V and can operate down to 2.4V.

The EL8178 draws minimal supply current while meeting excellent DC-accuracy noise and output drive specifications. Competing devices seriously degrade these parameters to achieve micropower supply current. Offset current, voltage and current noise, slew rate, and gain-bandwidth product are all two to ten times better than on previous micropower op amps.

The 1/f corner of the voltage noise spectrum is at 1kHz. This results in low frequency noise performance which can only be found on devices with an order of magnitude higher supply current.

The EL8178 can be operated from one lithium cell or two Ni-Cd batteries. The input range includes both positive and negative rail. The output swings to both rails.

### Ordering Information

PART NUMBER	PACKAGE	TAPE & REEL	PKG. DWG. #
EL8178AIW-T7	6-Pin SOT-23	7" (3K pcs)	MDP0038
EL8178AIW-T7A	6-Pin SOT-23	7" (250 pcs)	MDP0038
EL8178BIW-T7	6-Pin SOT-23	7" (3K pcs)	MDP0038
EL8178BIW-T7A	6-Pin SOT-23	7" (250 pcs)	MDP0038
EL8278IY (Note)	10-Pin MSOP	-	MDP0043
EL8278IL (Note)	10-Pin DFN	-	MDP0047

NOTE: Contact factory for availability

### Features

- 50µA supply current
- 100µV max offset voltage
- 1pA input bias current
- 400kHz gain-bandwidth product
- 0.13V/µs slew rate
- Single supply operation down to 2.4V
- Rail-to-rail input and output
- Output sources and sinks 26mA load current

### Applications

- Battery- or solar-powered systems
- 4mA to 25mA current loops
- Handheld consumer products
- Medical devices
- Thermocouple amplifiers
- Photodiode pre amps
- pH probe amplifiers

### Pinouts

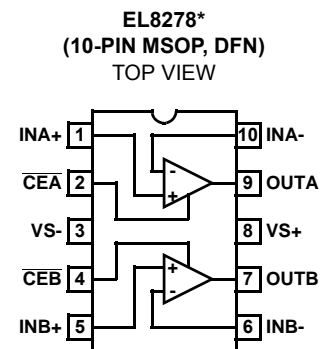
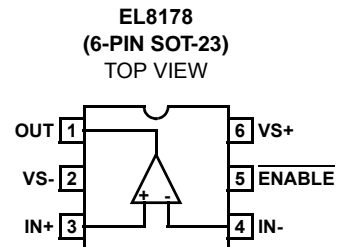

\*COMING SOON

**Absolute Maximum Ratings** ( $T_A = 25^\circ\text{C}$ )

Supply Voltage .....	5.5V	Output Short-Circuit Duration .....	Indefinite
Differential Input Voltage .....	0.5V	Ambient Operating Temperature Range .....	-40°C to +85°C
Input Voltage .....	-0.5V to $V_S + 0.5V$	Storage Temperature Range .....	-65°C to +150°C

CAUTION: Stresses above those listed in "Absolute Maximum Ratings" may cause permanent damage to the device. This is a stress only rating and operation of the device at these or any other conditions above those indicated in the operational sections of this specification is not implied.

IMPORTANT NOTE: All parameters having Min/Max specifications are guaranteed. Typical values are for information purposes only. Unless otherwise noted, all tests are at the specified temperature and are pulsed tests, therefore:  $T_J = T_C = T_A$

**Electrical Specifications**  $V_S = 5V, 0V, V_{CM} = 0.1V, V_O = 1.4V, T_A = 25^\circ\text{C}$  unless otherwise specified.

PARAMETER	DESCRIPTION	CONDITIONS	MIN	TYP	MAX	UNIT
V <sub>OS</sub>	Input Offset Voltage	Grade A		50	100	μV
		Grade B		110	400	μV
$\frac{\Delta V_{OS}}{\Delta \text{Time}}$	Long Term Input Offset Voltage Stability			TBD		μV/Mo
$\frac{\Delta V_{OS}}{\Delta T}$	Input Offset Drift vs Temperature			1.5		μV/°C
I <sub>B</sub>	Input Bias Current			1	50	pA
e <sub>N</sub>	Input Noise Voltage Density	f <sub>O</sub> = 1KHz		25		nV/√Hz
i <sub>N</sub>	Input Noise Current Density	f <sub>O</sub> = 1KHz		0.1		pA/√Hz
CMIR	Input Voltage Range	Guaranteed by CMRR test	0		5	V
CMRR	Input Voltage Range		0		5	V
CMRR	Common-Mode Rejection Ratio	V <sub>CM</sub> = 0V to 5V	80	100		dB
PSRR	Power Supply Rejection Ratio	V <sub>S</sub> = 3.3V to 5V	80	100		dB
A <sub>VOL</sub>	Large Signal Voltage Gain	V <sub>O</sub> = 0.5V to 4.5V, R <sub>L</sub> = 100kΩ	100	400		V/mV
		V <sub>O</sub> = 0.5V to 4.5V, R <sub>L</sub> = 1kΩ		15		V/mV
V <sub>OUT</sub>	Maximum Output Voltage Swing	Output low, R <sub>L</sub> = 100kΩ		3	6	mV
		Output low, R <sub>L</sub> = 1kΩ		130	200	mV
		Output high, R <sub>L</sub> = 100kΩ	4.994	4.997		V
		Output high, R <sub>L</sub> = 1kΩ	4.8	4.88		V
SR	Slew Rate		0.09	0.13	0.16	V/μs
GBW	Gain Bandwidth Product	f <sub>O</sub> = 100kHz		400		kHz
I <sub>S,ON</sub>	Supply Current, Enabled		40	50	75	μA
I <sub>S,OFF</sub>	Supply Current, Disabled			3	10	μA
I <sub>O+</sub>	Short Circuit Output Current	R <sub>L</sub> = 10Ω	18	31		mA
I <sub>O-</sub>	Short Circuit Output Current	R <sub>L</sub> = 10Ω	17	26		mA
V <sub>S</sub>	Minimum Supply Voltage			2.2	2.4	V
V <sub>INH</sub>	Enable Pin High Level				2	V
V <sub>INL</sub>	Enable Pin Low Level		0.8			V
I <sub>ENH</sub>	Enable Pin Input Current	V <sub>EN</sub> = 5V	0.25	0.7	2	μA
I <sub>ENL</sub>	Enable Pin Input Current	V <sub>EN</sub> = 0V	-0.5	0	+0.5	μA

Typical Performance Curves

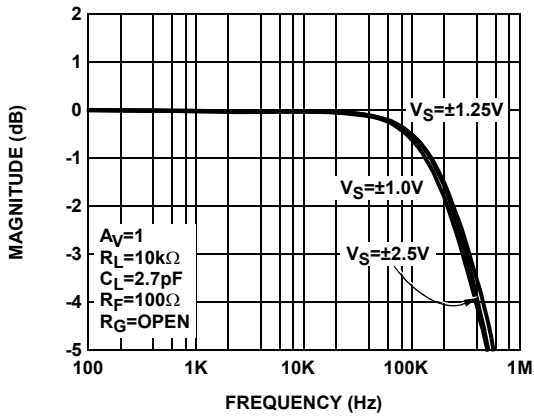

FIGURE 1. FREQUENCY RESPONSE vs SUPPLY VOLTAGE

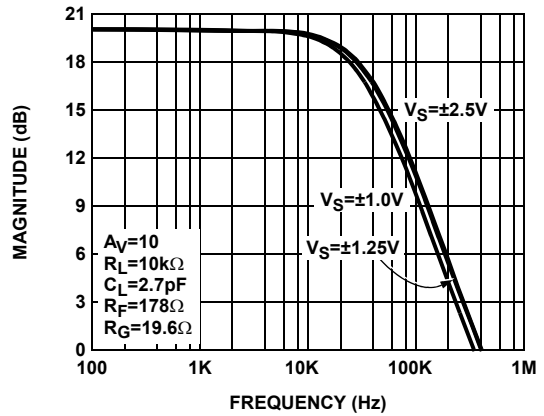

FIGURE 2. FREQUENCY RESPONSE vs SUPPLY VOLTAGE

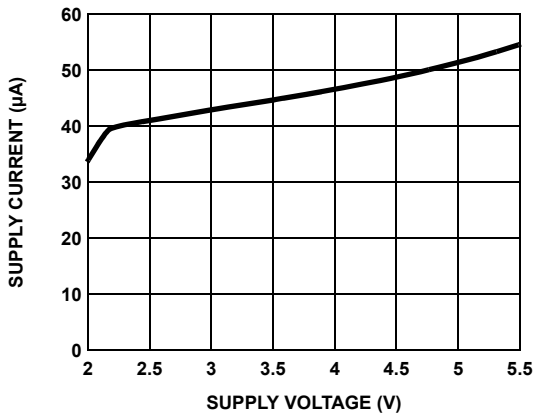

FIGURE 3. SUPPLY CURRENT vs SUPPLY VOLTAGE

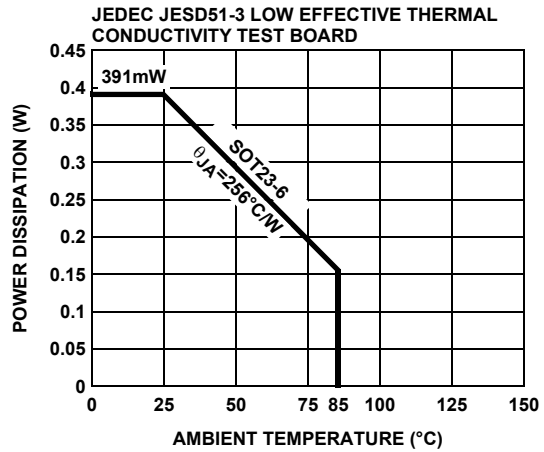

FIGURE 4. PACKAGE POWER DISSIPATION vs AMBIENT TEMPERATURE

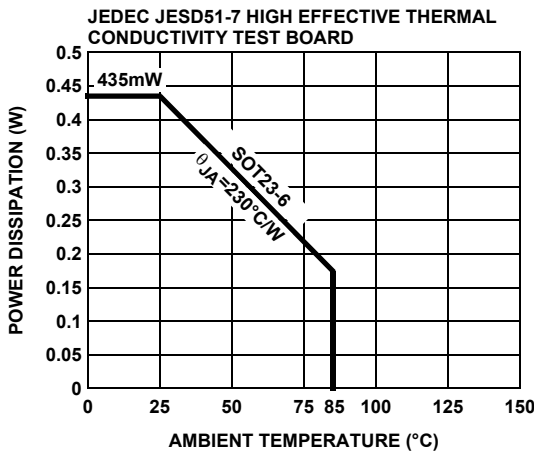

FIGURE 5. PACKAGE POWER DISSIPATION vs AMBIENT TEMPERATURE

All Intersil U.S. products are manufactured, assembled and tested utilizing ISO9000 quality systems.  
Intersil Corporation's quality certifications can be viewed at [www.intersil.com/design/quality](http://www.intersil.com/design/quality)

---

*Intersil products are sold by description only. Intersil Corporation reserves the right to make changes in circuit design, software and/or specifications at any time without notice. Accordingly, the reader is cautioned to verify that data sheets are current before placing orders. Information furnished by Intersil is believed to be accurate and reliable. However, no responsibility is assumed by Intersil or its subsidiaries for its use; nor for any infringements of patents or other rights of third parties which may result from its use. No license is granted by implication or otherwise under any patent or patent rights of Intersil or its subsidiaries.*

---

For information regarding Intersil Corporation and its products, see [www.intersil.com](http://www.intersil.com)