

Silicon Schottky Barrier Detector Diodes



CDB, DDB Series

Features

- Low 1/f Noise
- Bonded Junctions for Reliability
- Planar Passivated Beam-Lead and Chip Construction

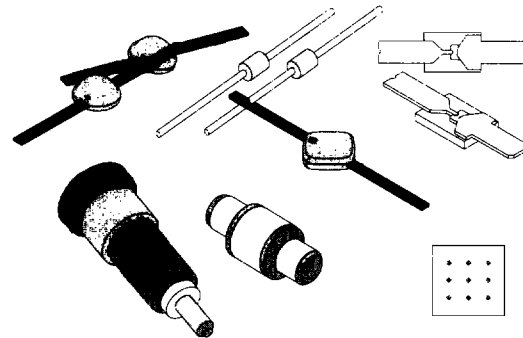

Description

Alpha packaged, beam-lead and chip Schottky barrier detector diodes are designed for applications through 40 GHz in Ka-band. They are made by the deposition of a suitable barrier metal on an epitaxial silicon substrate to form the junction. The process and choice of materials result in low series resistance along with a narrow spread of capacitance values for close impedance control. P-type silicon is used to obtain superior 1/f noise characteristics.

The packaged diodes are suitable for use in waveguide, coaxial, and stripline applications.

Applications

These diodes are categorized by TSS (Tangential Signal Sensitivity) for detector applications in four frequency ranges: S, X, Ku, and Ka-band. However, they can also be used as modulators, high speed switches and low power limiters. RF parameters on chips and beam-lead diodes are tested on a sample basis, while breakdown voltage and capacitance measurements are 100% tested. Packaged diodes are 100% RF tested.

The beam-lead and chip diodes can also be mounted in a variety of packages or on special customer substrates.

Unmounted beam-lead diodes are especially well suited for use in MIC applications. Mounted beam-lead diodes can be easily used in MIC, stripline or other such circuitry.

A complete line of chips is shown for those MIC applications where the chip and wire approach is more desirable.

TSS, is the one parameter that best describes a diode's use as a video detector. It is defined as the amount of signal power, below a one milliwatt reference level, required to produce an output pulse whose amplitude is sufficient to raise the noise fluctuations by an amount equal to the average noise level. TSS is approximately 4 dB above the Minimum Detectable Signal.

The Schottky barrier diodes in this data sheet are of P-type construction and are optimized for low noise, particularly in the 1/f region. They require a small forward bias (to overcome the barrier potential) if efficient operation is required, especially at power levels below -20 dBm. Bias not only increases sensitivity but also greatly reduces parameter variation due to temperature change. Video impedance is a direct function of bias and closely follows the $28/I$ (mA) relationship. This is important

to pulse fidelity, since the video impedance in conjunction with the detector output capacitance affects the effective amplifier bandwidth.

Bias does, however, increase noise, particularly in the 1/f region. Therefore, it should be kept at as low a level as possible (typically 5–50 microamps).

Voltage output versus power input as a function of load resistance and bias is shown in Figures 1a and 1b.

Electrical Specifications

Packaged Low 1/f Noise (6.0 dB Max)

Frequency Band	Part Number	Electrical Characteristics				Test Conditions		Outline Drawing Number
		TSS – dBm ^{1,2}	Z _{IF} (Ohms)		C _J @ 0V (pF)	Frequency GHz	Holder	
		min	min	max	max			
C-X	DDB4517-006	50	500	700	–	5, 11	P-066	207-001
C-X	DDL6672-006	48	500	700	–	5, 11	P-085	075-001 ⁴
C-X	DDB4517-000	47	500	700	–	5, 11	P-066	207-001
C-X	DDL6672-000	45	500	700	–	5, 11	P-085	075-001 ⁴
X	DDL6725-000	48	500	700	–	10.525	Optimized	005-801
K	DDB6673-094	50	–	–	0.10	24.15	Optimized	207-001
KA	DDB6673-000	40	500	700	–	34.86	P-064	207-001

Beam-Lead Low 1/f Noise (6.0 dB Max)

X	DDB4719-000	50	500	700	0.15	10	–	130-011
X	DDB2503-000	50	500	700	0.15	10	–	491-006
X	DDB3321-000	50	500	700	0.15	10	–	295-011
X	DDB3268-000	50	500	700	0.15	10	–	364-011
Ku	DDB3263-000	48	500	700	0.10	16	–	130-011
Ku	DDB2504-000	48	500	700	0.10	16	–	491-006
Ku	DDB3266-000	49	500	700	0.10	16	–	295-011
Ku	DDB4393-000	49	500	700	0.10	16	–	364-011
K	DDB5098-000	50 ³	800 ³	1200 ³	0.10	24.15	–	130-011
K	DDB2265-000	50 ³	800 ³	1200 ³	0.10	24.15	–	491-006
K	DDB3267-000	50 ³	800 ³	1200 ³	0.10	24.15	–	295-011
K	DDB3269-000	50 ³	800 ³	1200 ³	0.10	24.15	–	364-011

Chip Low 1/f Noise (6.0 dB Max)

X/Ku	CDB7620-000	50	500	700	0.15	18	–	526-006
Ku/K	CDB7619-000	48	500	700	0.10	20	–	526-006

1. Bias = 50 μ A.
 2. Video Bandwidth = 10 MHz.
 3. Bias = 30 μ A.
 4. For stripline applications, all diodes in the 075-001 package are available with flattened leads.
- Maximum operating temperature = 150°C.

Typical Performance Data

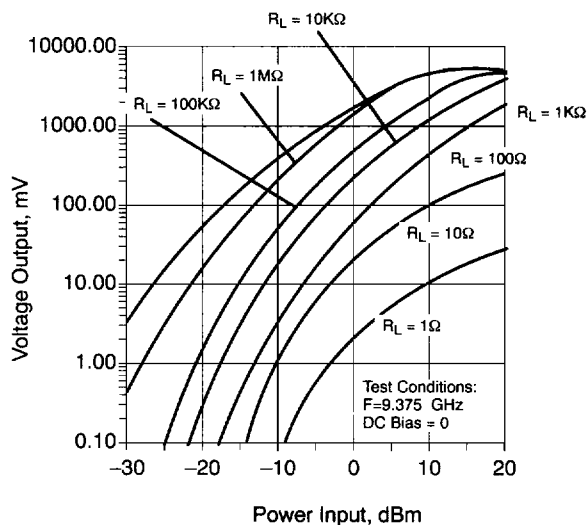

Figure 1a. Voltage Output vs. Power Input as a Function of Load Resistance

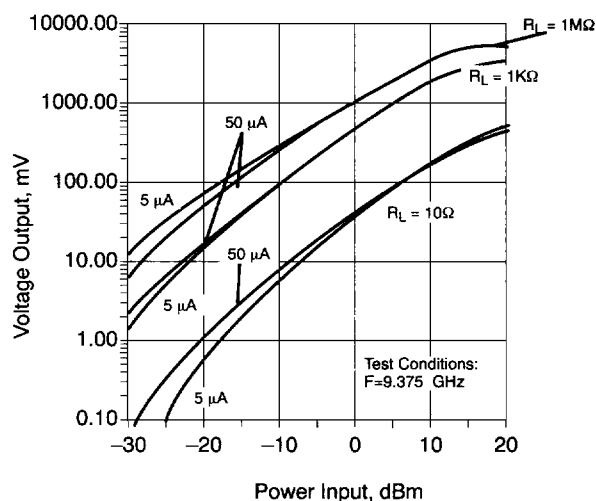
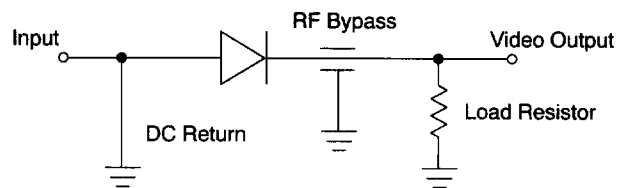

Figure 1b. Voltage Output vs. Power Input as a Function of Load Resistance and Bias

Frequency Table

Band	Frequencies (GHz)
UHF	Up to 1
L	1 - 2
S	2 - 4
C	4 - 8
X	8.2 - 12.4
Ku	12.4 - 18
K	18.0 - 26.5
Ka	26.5 - 40
mm	40 - 100

a) Unbiased



a) Biased

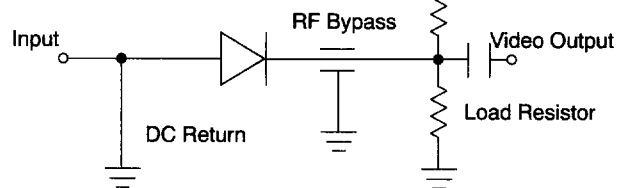

Multi Octave-High Sensitivity

a) Unbiased

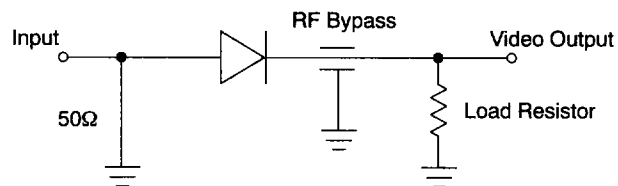

a) Biased

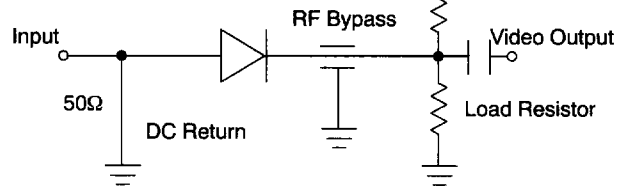

Broadband-Low Sensitivity

Figure 2. Typical Video Detector Circuits