

# MRA4003T3G Series, NRVA4003T3G Series

## Surface Mount Standard Recovery Power Rectifier

### SMA Power Surface Mount Package

Features construction with glass passivation. Ideally suited for surface mounted automotive applications.

#### Features

- Compact Package with J-Bend Leads Ideal for Automated Handling
- Stable, High Temperature, Glass Passivated Junction
- NRVA Prefix for Automotive and Other Applications Requiring Unique Site and Control Change Requirements; AEC-Q101 Qualified and PPAP Capable
- These Devices are Pb-Free and are RoHS Compliant\*

#### Mechanical Characteristics

- Case: Molded Epoxy  
Epoxy meets UL 94 V-0 @ 0.125 in
- Weight: 70 mg (Approximately)
- Finish: All External Surfaces are Corrosion Resistant and Terminal Leads are Readily Solderable
- Lead and Mounting Surface Temperature for Soldering Purposes: 260°C Max. for 10 seconds in Solder Bath
- Polarity: Band in Plastic Body Indicates Cathode Lead
- Marking: MRA4003T3G = R13  
MRA4004T3G = R14  
MRA4005T1G = R15  
MRA4005T3G = R15  
MRA4006T3G = R16  
MRA4007T3G = R17  
NRVA4004T3G = R14  
NRVA4005T3G = R15  
NRVA4006T3G = R16  
NRVA4007T3G = R17
- ESD Rating:
  - ◆ Human Body Model 3A
  - ◆ Machine Model C



ON Semiconductor®

<http://onsemi.com>

**STANDARD RECOVERY  
RECTIFIERS  
1.0 AMPERES  
300-1000 VOLTS**



CASE 403D  
SMA

#### MARKING DIAGRAM



R1x = Specific Device Code  
F = Wafer Source  
A = Assembly Location  
Y = Year  
WW = Work Week  
▪ = Pb-Free Package

(Note: Microdot may be in either location)

#### ORDERING INFORMATION

See detailed ordering and shipping information in the ordering information section on page 4 of this data sheet.

\*For additional information on our Pb-Free strategy and soldering details, please download the ON Semiconductor Soldering and Mounting Techniques Reference Manual, SOLDERRM/D.

# MRA4003T3G Series, NRVA4003T3G Series

## MAXIMUM RATINGS

Rating	Symbol	Value					Unit
		MRA4003	MRA4004/ NRVA4004	MRA4005/ NRVA4005	MRA4006/ NRVA4006	MRA4007/ NRVA4007	
Peak Repetitive Reverse Voltage Working Peak Reverse Voltage DC Blocking Voltage	$V_{RRM}$ $V_{RWM}$ $V_R$	300	400	600	800	1000	Volts
Avg. Rectified Forward Current (At Rated $V_R$ , $T_L = 150^\circ\text{C}$ )	$I_O$	1					Amp
Peak Repetitive Forward Current (At Rated $V_R$ , Square Wave, 20 kHz, $T_L = 150^\circ\text{C}$ )	$I_{FRM}$	2					Amps
Non-Repetitive Peak Surge Current (Surge applied at rated load conditions, halfwave, single phase, 60 Hz)	$I_{FSM}$	30					Amps
Storage/Operating Case Temperature	$T_{stg}$ , $T_C$	-55 to 150					$^\circ\text{C}$
Operating Junction Temperature	$T_J$	-55 to 175					$^\circ\text{C}$

Stresses exceeding Maximum Ratings may damage the device. Maximum Ratings are stress ratings only. Functional operation above the Recommended Operating Conditions is not implied. Extended exposure to stresses above the Recommended Operating Conditions may affect device reliability.

## THERMAL CHARACTERISTICS

Characteristic	Symbol	Value	Unit
Thermal Resistance, Junction-to-Lead (Note 1)	$R_{\theta JL}$	16.2	$^\circ\text{C}/\text{W}$
Thermal Resistance, Junction-to-Ambient (Note 2)	$R_{\theta JA}$	88.3	$^\circ\text{C}/\text{W}$

## ELECTRICAL CHARACTERISTICS

Characteristic	Symbol	Value		Unit
		$T_J = 25^\circ\text{C}$	$T_J = 100^\circ\text{C}$	
Maximum Instantaneous Forward Voltage (Note 3) ( $I_F = 1\text{ A}$ ) ( $I_F = 2\text{ A}$ )	$V_F$	1.1 1.18	1.04 1.12	Volts
Maximum Instantaneous Reverse Current (at rated DC voltage)	$I_R$	10	50	$\mu\text{A}$

1. Minimum Pad Size
2. 1 inch Pad Size
3. Pulse Test: Pulse Width  $\leq 250\ \mu\text{s}$ , Duty Cycle  $\leq 2\%$ .

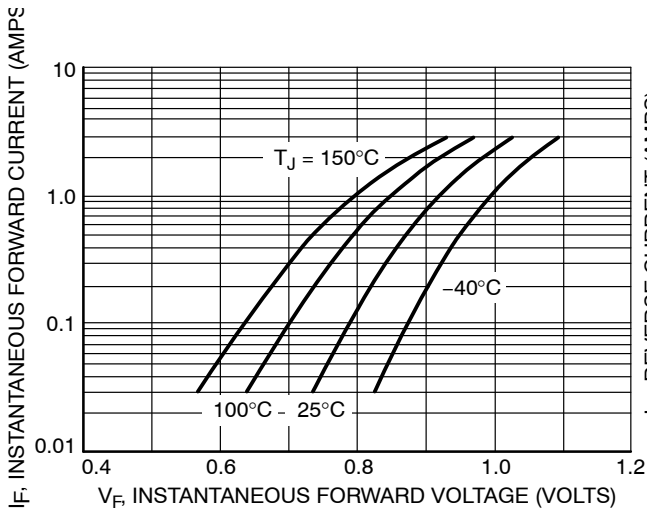

Figure 1. Typical Forward Voltage

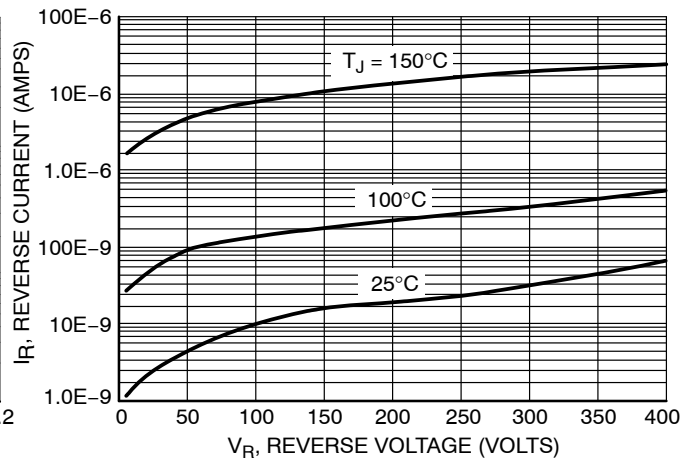

Figure 2. Typical Reverse Current

# MRA4003T3G Series, NRVA4003T3G Series

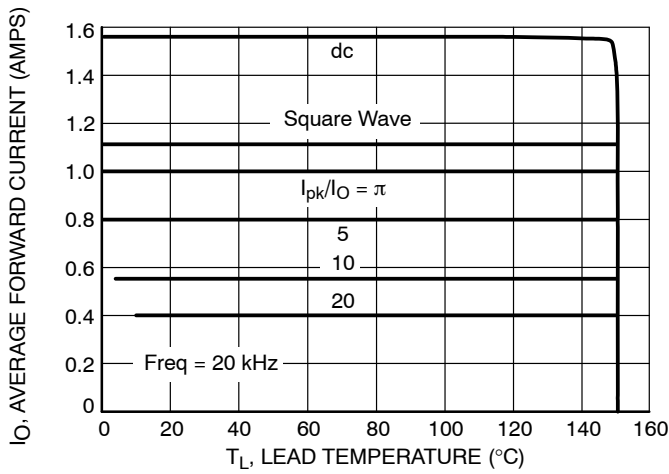

Figure 3. Current Derating per Leg

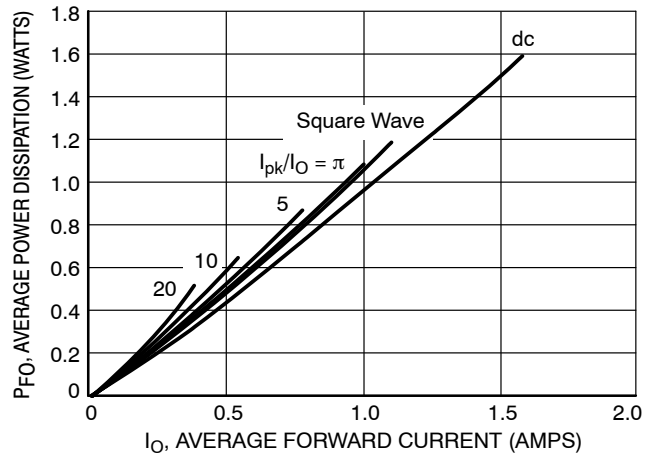

Figure 4. Forward Power Dissipation per Leg

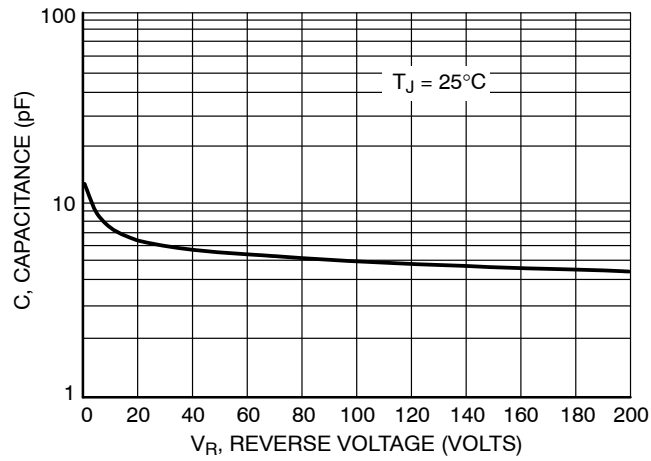

Figure 5. Capacitance

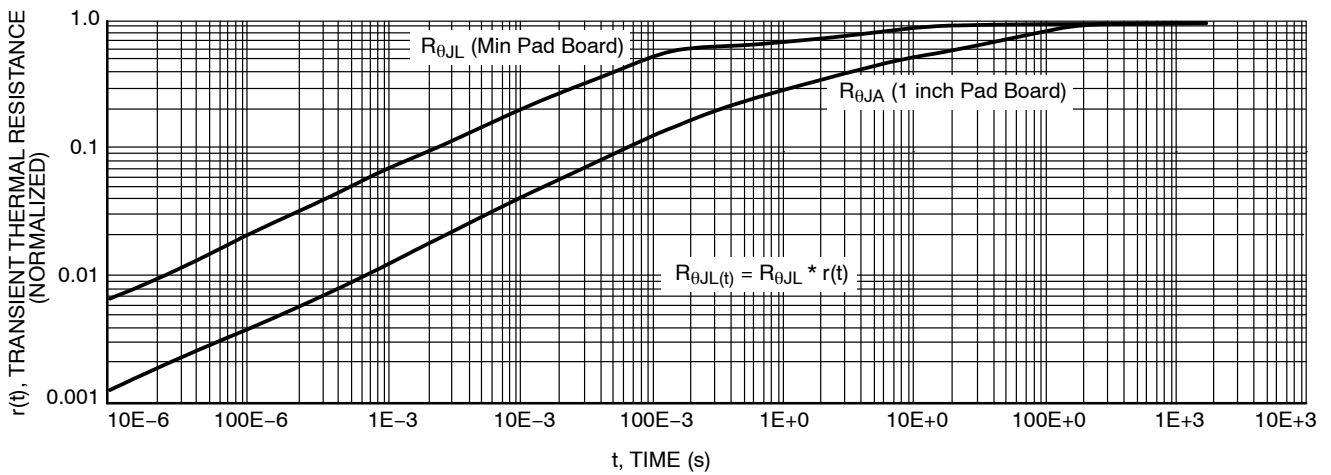

Figure 6. Thermal Response

## MRA4003T3G Series, NRVA4003T3G Series

### ORDERING INFORMATION

Device	Package	Shipping†
MRA4003T3G	SMA (Pb-Free)	5,000 / Tape & Reel
MRA4004T3G		
MRA4005T1G		1,500 / Tape & Reel
MRA4005T3G		5,000 / Tape & Reel
MRA4006T3G		
MRA4007T3G		
NRVA4004T3G*		
NRVA4005T3G*		
NRVA4006T3G*		
NRVA4007T3G*		

†For information on tape and reel specifications, including part orientation and tape sizes, please refer to our Tape and Reel Packaging Specifications Brochure, BRD8011/D.

\*NRVA Prefix for Automotive and Other Applications Requiring Unique Site and Control Change Requirements; AEC-Q101 Qualified and PPAP Capable.

# MRA4003T3G Series, NRVA4003T3G Series

## PACKAGE DIMENSIONS

### SMA CASE 403D-02 ISSUE G

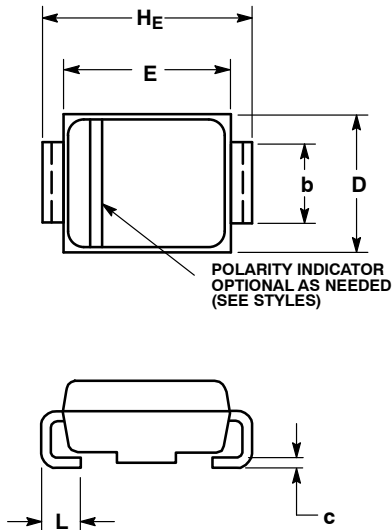

- NOTES:
1. DIMENSIONING AND TOLERANCING PER ANSI Y14.5M, 1982.
  2. CONTROLLING DIMENSION: INCH.
  3. DIMENSION b SHALL BE MEASURED WITHIN DIMENSION L.

DIM	MILLIMETERS			INCHES		
	MIN	NOM	MAX	MIN	NOM	MAX
A	1.97	2.10	2.20	0.078	0.083	0.087
A1	0.05	0.10	0.20	0.002	0.004	0.008
b	1.27	1.45	1.63	0.050	0.057	0.064
c	0.15	0.28	0.41	0.006	0.011	0.016
D	2.29	2.60	2.92	0.090	0.103	0.115
E	4.06	4.32	4.57	0.160	0.170	0.180
HE	4.83	5.21	5.59	0.190	0.205	0.220
L	0.76	1.14	1.52	0.030	0.045	0.060

### SOLDERING FOOTPRINT\*

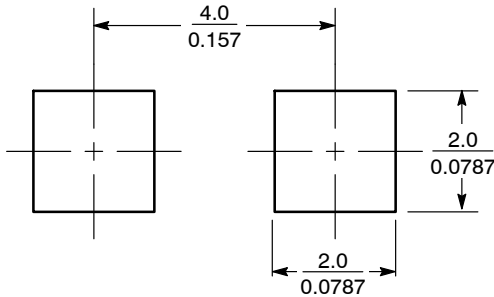

SCALE 8:1  $\left(\frac{\text{mm}}{\text{inches}}\right)$

\*For additional information on our Pb-Free strategy and soldering details, please download the ON Semiconductor Soldering and Mounting Techniques Reference Manual, SOLDERRM/D.

ON Semiconductor and  are registered trademarks of Semiconductor Components Industries, LLC (SCILLC). SCILLC owns the rights to a number of patents, trademarks, copyrights, trade secrets, and other intellectual property. A listing of SCILLC's product/patent coverage may be accessed at [www.onsemi.com/site/pdf/Patent-Marking.pdf](http://www.onsemi.com/site/pdf/Patent-Marking.pdf). SCILLC reserves the right to make changes without further notice to any products herein. SCILLC makes no warranty, representation or guarantee regarding the suitability of its products for any particular purpose, nor does SCILLC assume any liability arising out of the application or use of any product or circuit, and specifically disclaims any and all liability, including without limitation special, consequential or incidental damages. "Typical" parameters which may be provided in SCILLC data sheets and/or specifications can and do vary in different applications and actual performance may vary over time. All operating parameters, including "Typicals" must be validated for each customer application by customer's technical experts. SCILLC does not convey any license under its patent rights nor the rights of others. SCILLC products are not designed, intended, or authorized for use as components in systems intended for surgical implant into the body, or other applications intended to support or sustain life, or for any other application in which the failure of the SCILLC product could create a situation where personal injury or death may occur. Should Buyer purchase or use SCILLC products for any such unintended or unauthorized application, Buyer shall indemnify and hold SCILLC and its officers, employees, subsidiaries, affiliates, and distributors harmless against all claims, costs, damages, and expenses, and reasonable attorney fees arising out of, directly or indirectly, any claim of personal injury or death associated with such unintended or unauthorized use, even if such claim alleges that SCILLC was negligent regarding the design or manufacture of the part. SCILLC is an Equal Opportunity/Affirmative Action Employer. This literature is subject to all applicable copyright laws and is not for resale in any manner.

### PUBLICATION ORDERING INFORMATION

**LITERATURE FULFILLMENT:**  
Literature Distribution Center for ON Semiconductor  
P.O. Box 5163, Denver, Colorado 80217 USA  
**Phone:** 303-675-2175 or 800-344-3860 Toll Free USA/Canada  
**Fax:** 303-675-2176 or 800-344-3867 Toll Free USA/Canada  
**Email:** [orderlit@onsemi.com](mailto:orderlit@onsemi.com)

**N. American Technical Support:** 800-282-9855 Toll Free  
USA/Canada  
**Europe, Middle East and Africa Technical Support:**  
Phone: 421 33 790 2910  
**Japan Customer Focus Center**  
Phone: 81-3-5817-1050

**ON Semiconductor Website:** [www.onsemi.com](http://www.onsemi.com)  
**Order Literature:** <http://www.onsemi.com/orderlit>

For additional information, please contact your local Sales Representative