

DESCRIPTION

- 140 MHz SAW bandpass filter with 2.2 MHz bandwidth.
- 13.3 x 6.5 mm SMP.
- RoHS compliant.

TYPICAL PERFORMANCE

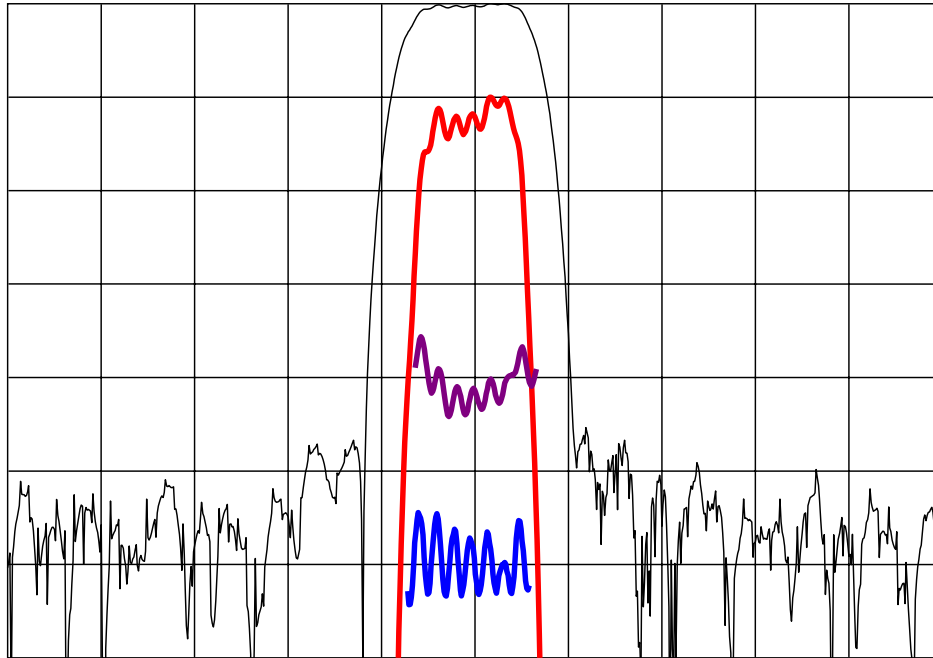

Horizontal: Frequency : 3 MHz/div
 Vertical from Top: Relative Magnitude : 10 dB/div
 Relative magnitude : 1 dB/div
 Phase Linearity : 5 deg/div
 Group Delay Deviation : 100 ns/div

S11 (125 to 155 MHz)

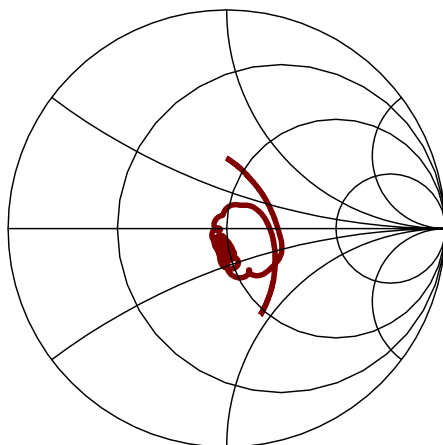

S22 (125 to 155 MHz)

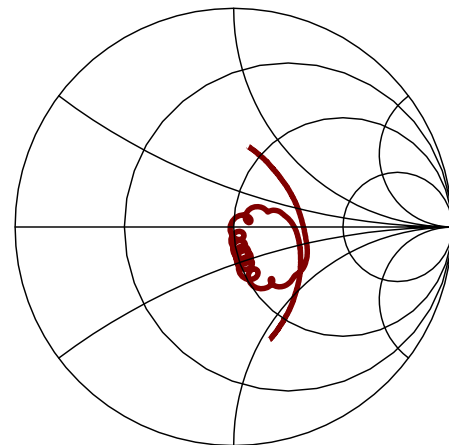

SPECIFICATION

Parameter	Min	Typ	Max	Units
Center Frequency, F_c ¹	139.70	140.00	140.30	MHz
Insertion Loss at F_c	10	12	13	dB
1 dB Bandwidth ²	2.20	2.28	-	MHz
3 dB Bandwidth ²	2.30	2.73	-	MHz
40 dB Bandwidth ²	-	4.30	4.50	MHz
Ultimate Rejection (70 to 210 MHz) ²	40	45	-	dB
Passband Ripple ($F_c \pm 1$ MHz)	-	0.6	1.0	dB p-p
Phase Ripple ($F_c \pm 1$ MHz)	-	2.5	5	deg p-p
Group Delay Ripple ($F_c \pm 0.8$ MHz)	-	50	300	ns/div
Temperature Coefficient of Frequency	-	-23	-	ppm/°C
Source/Load Impedance	50			ohms
Ambient Temperature	-	25	-	°C

- Notes: 1. Defined as the average of the lower and upper 3 dB frequencies at room ambient.
2. All dB levels are defined relative to the insertion loss.

MAXIMUM RATINGS

Parameter	Min	Max	Units
Storage Temperature Range	-40	85	°C
Operating Temperature Range	5	50	°C
Input Power Level	-	10	dBm

MATCHING CIRCUIT

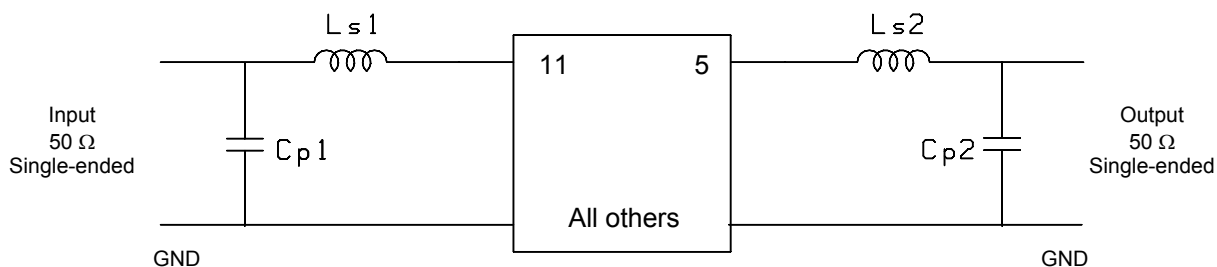

Typical component values:

$$\begin{aligned} L_{s1} &= 52 \text{ nH} & L_{s2} &= 59.3 \text{ nH} \\ C_{p1} &= 39 \text{ pF} & C_{p2} &= 41 \text{ pF} \end{aligned}$$

Notes:

1. Recommend use of 2% tolerance matching components.
2. Component values are for reference only and may change depending on board layout.

PACKAGE OUTLINE

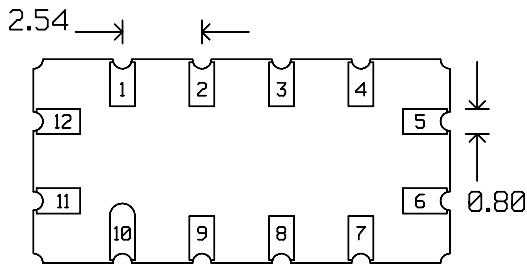
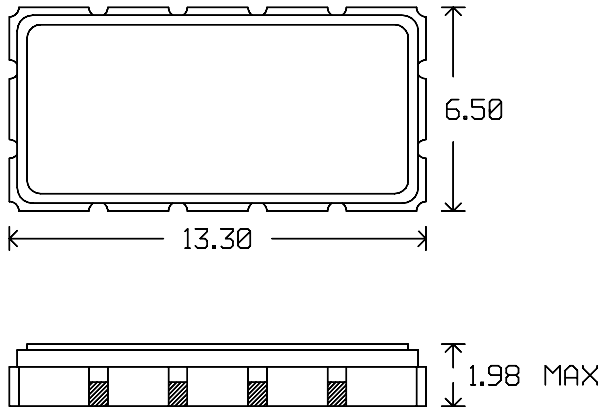

Package Material:
Body: Al_2O_3 ceramic
Lid: Kovar, Ni plated
Terminations: Au plating 1 μ m min,
over a 1.3-8.9 μ m Ni plating

SUGGESTED FOOTPRINT

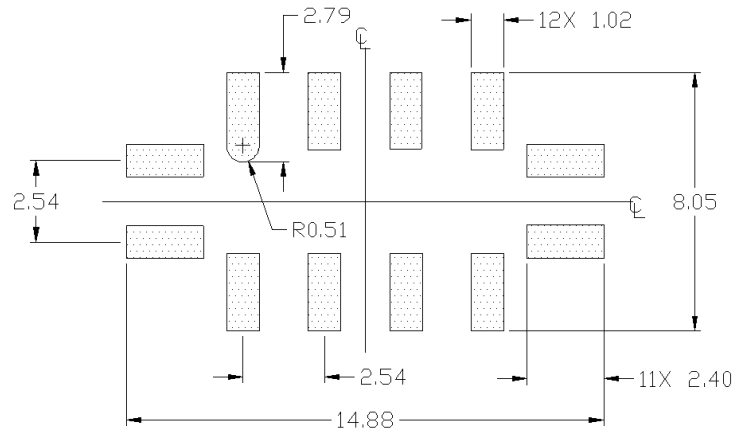

Units: mm

Tolerances are ± 0.15 mm except for the overall length and width, which are nominal values.

Pad Configuration:

Input: 11
Output: 5
Ground: 1,2,3,4,6,7,8,9,10,12

ISO 9001
Registered

All specifications are believed to be accurate and reliable. However, Spectrum Microwave reserves the right to make changes without notice.
© 2010 All rights reserved.