

# Specification for Approval

( Ver 1.0 )

Part No. : LWM1037N

comments

LUXPIA Co., Ltd.

Designed by	Checked by	Approved by
/	/	/

Approved by	Approved by	Approved by
/	/	/

Date : \_\_\_\_\_ . \_\_\_\_\_ . \_\_\_\_\_ .

Date : \_\_\_\_\_ . \_\_\_\_\_ . \_\_\_\_\_ .

- CONTENTS -

1. Features
2. Package Outline Dimensions and Materials
3. Absolute Maximum Ratings
4. Electro-Optical Characteristics
5. CIE Chromaticity Diagram
6. Materials
7. Taping
8. Packing
9. Reliability
10. Cautions
11. Warranty
12. Characteristic Diagrams

## 1. Features

- Package : SMD Top View Type (1chip, 1Zener in 1PKG)
- Dimension : 3.5 × 2.8 × 0.8 mm (L×W×H)
- Small size surface mount type
- Viewing angle : extremely wide(120°)
- Soldering methods : IR reflow soldering

## 2. Package Outline Dimensions and Recommended Solder Patterns

(units : mm)

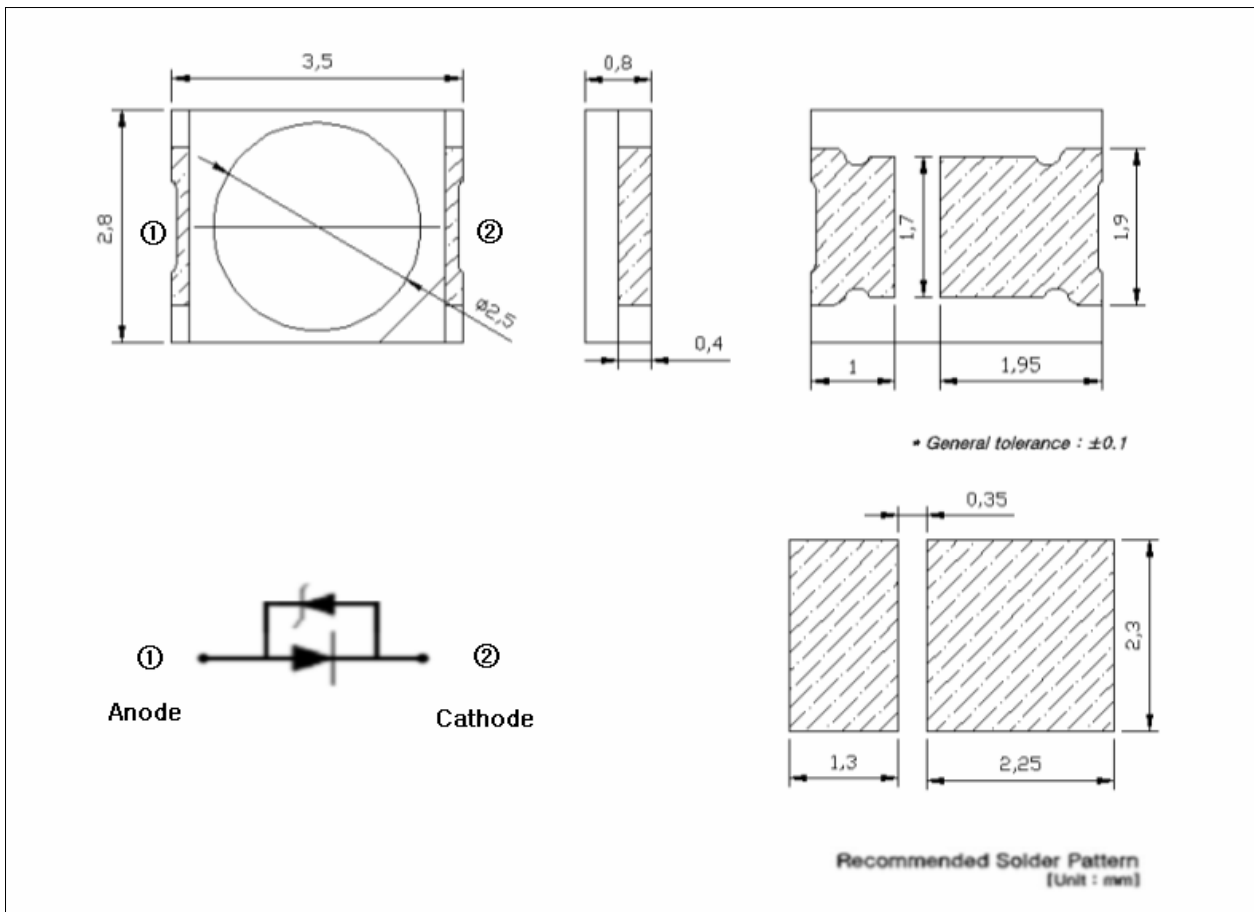

### 3. Absolute Maximum Ratings

( $T_a=25$  )

Iem	Smbol	Vlue	Unit
Forward Current	$I_F$	60	mA
Pulse Forward Current <sup>1)</sup>	$I_{FP}$	150	mA
Reverse Voltage	$V_R$	5	V
Power Dissipation	$P_D$	200	mW
Operating Temperature	$T_{opr}$	-30 to+85	
Storage Temperature	$T_{stg}$	-40 to +100	

<sup>1)</sup>  $I_{FP}$  conditions : pulse width  $\leq 10$ msec & duty ratio  $\leq 1/10$

### 4. Electro-Optical Characteristics

( $T_a=25$  )

Item	Rank	Symbol	Condition	Min	Typ	Max	Unit
Forward voltage <sup>3)</sup>	V28	$V_F$	$I_F= 60$ mA	2.8	-	2.9	V
	V29			2.9	-	3.0	
	V30			3.0	-	3.1	
	V31			3.1	-	3.2	
	V32			3.2	-	3.3	
Luminous intensity <sup>4)</sup>	3E60	$I_V$	$I_F= 60$ mA	6.0	-	6.5	cd
	3E65			6.5	-	7.0	
	3E70			7.0	-	7.5	
	3E75			7.5	-	8.0	
Reverse current	-	$I_R$	$V_R= 5$ V	-	-	150	$\mu$ A

<sup>2)</sup> Forward voltages are tested at a current pulse duration of 10 ms and an accuracy within  $\pm 0.1$ V.

<sup>3)</sup> Dominant wavelength are tested at a current pulse duration of 10 ms and an accuracy within  $\pm 1$ nm.

<sup>4)</sup> The allowance of luminous intensity measurement is within  $\pm 10$ %.

\* To avoid optical difference, please do not mix differently ranked product.

\* All measurements were made under the standardized environment of LUXPIA.

## 5. CIE Chromaticity Diagram <sup>5)</sup>

( $T_a=25$  ,  $I_f=20\text{mA}$ )

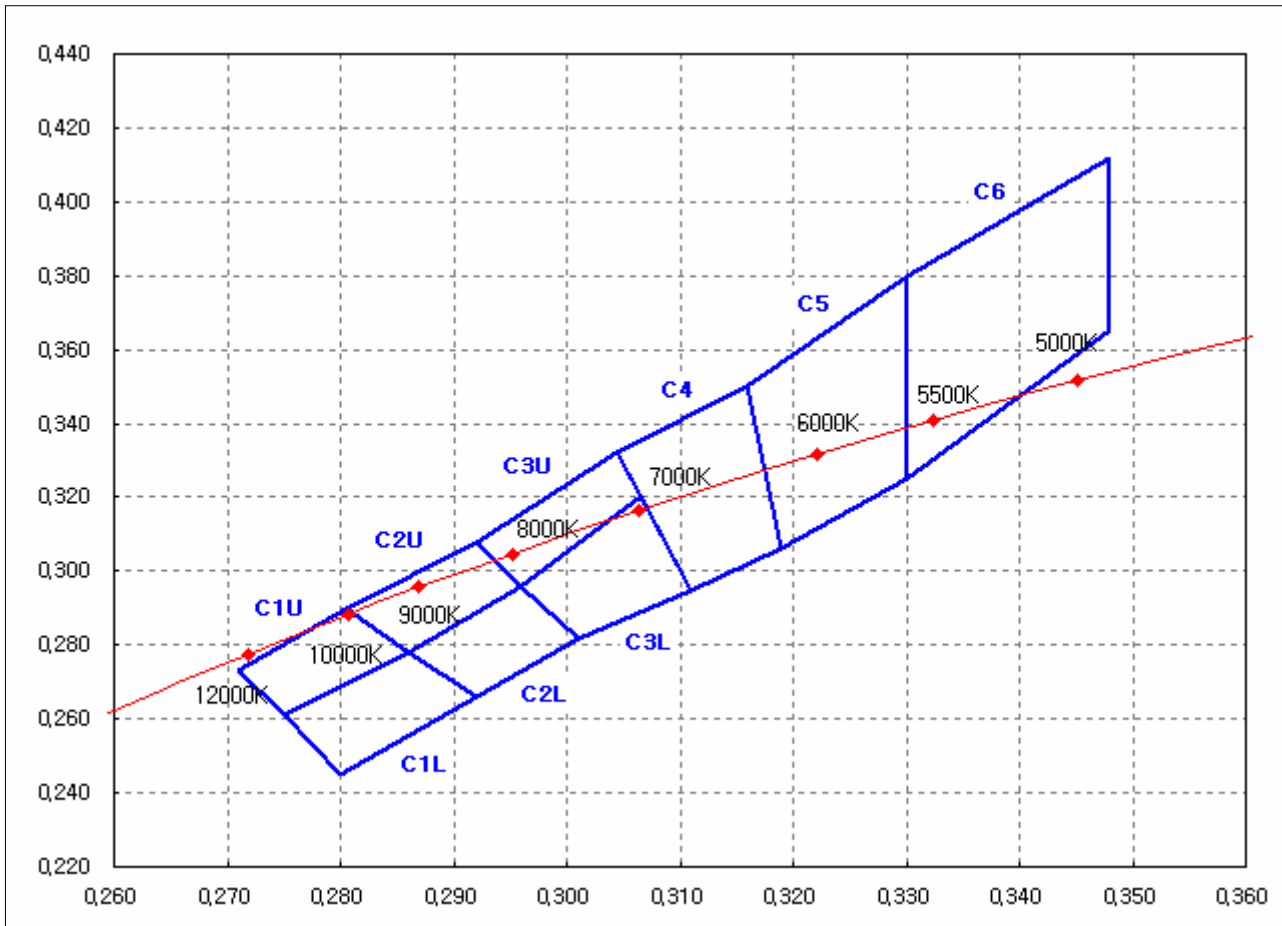

C1U		C1L		C2U		C2L		C3U	
x	y	x	y	x	y	x	y	x	y
0.2750	0.2610	0.2800	0.2450	0.2860	0.2780	0.2920	0.2660	0.2960	0.2960
0.2710	0.2730	0.2750	0.2610	0.2805	0.2900	0.2860	0.2780	0.2920	0.3080
0.2805	0.2900	0.2860	0.2780	0.2920	0.3080	0.2960	0.2960	0.3045	0.3320
0.2860	0.2780	0.2920	0.2660	0.2960	0.2960	0.3010	0.2820	0.3065	0.3200

C3L		C4		C5		C6	
x	y	x	y	x	y	x	y
0.3010	0.2820	0.3110	0.2950	0.3190	0.3060	0.3300	0.3250
0.2960	0.2960	0.3045	0.3320	0.3160	0.3500	0.3300	0.3800
0.3065	0.3200	0.3160	0.3500	0.3300	0.3800	0.3480	0.4120
0.3110	0.2950	0.3190	0.3060	0.3300	0.3250	0.3480	0.3650

(  $T_a=25$  ,  $I_F=20\text{mA}$  )

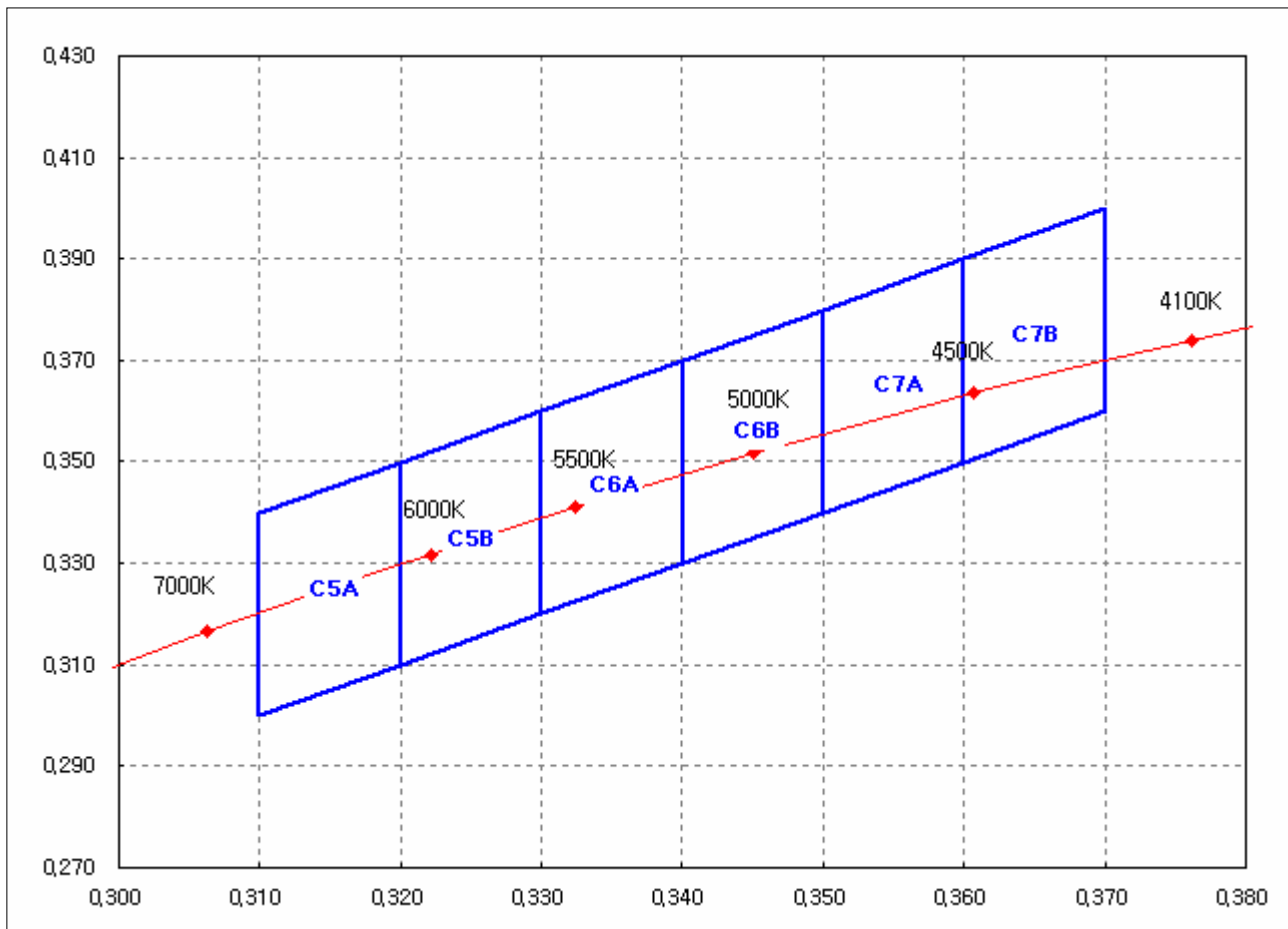

C5A		C5B		C6A		C6B	
x	y	x	y	x	y	x	y
0.3100	0.3000	0.3200	0.3100	0.3300	0.3200	0.3400	0.3300
0.3100	0.3400	0.3200	0.3500	0.3300	0.3600	0.3400	0.3700
0.3200	0.3500	0.3300	0.3600	0.3400	0.3700	0.3500	0.3800
0.3200	0.3100	0.3300	0.3200	0.3400	0.3300	0.3500	0.3400

C7A		C7B	
x	y	x	y
0.3500	0.3400	0.3600	0.3500
0.3500	0.3800	0.3600	0.3900
0.3600	0.3900	0.3700	0.4000
0.3600	0.3500	0.3700	0.3600

( $T_a=25$  ,  $I_f=20\text{mA}$ )

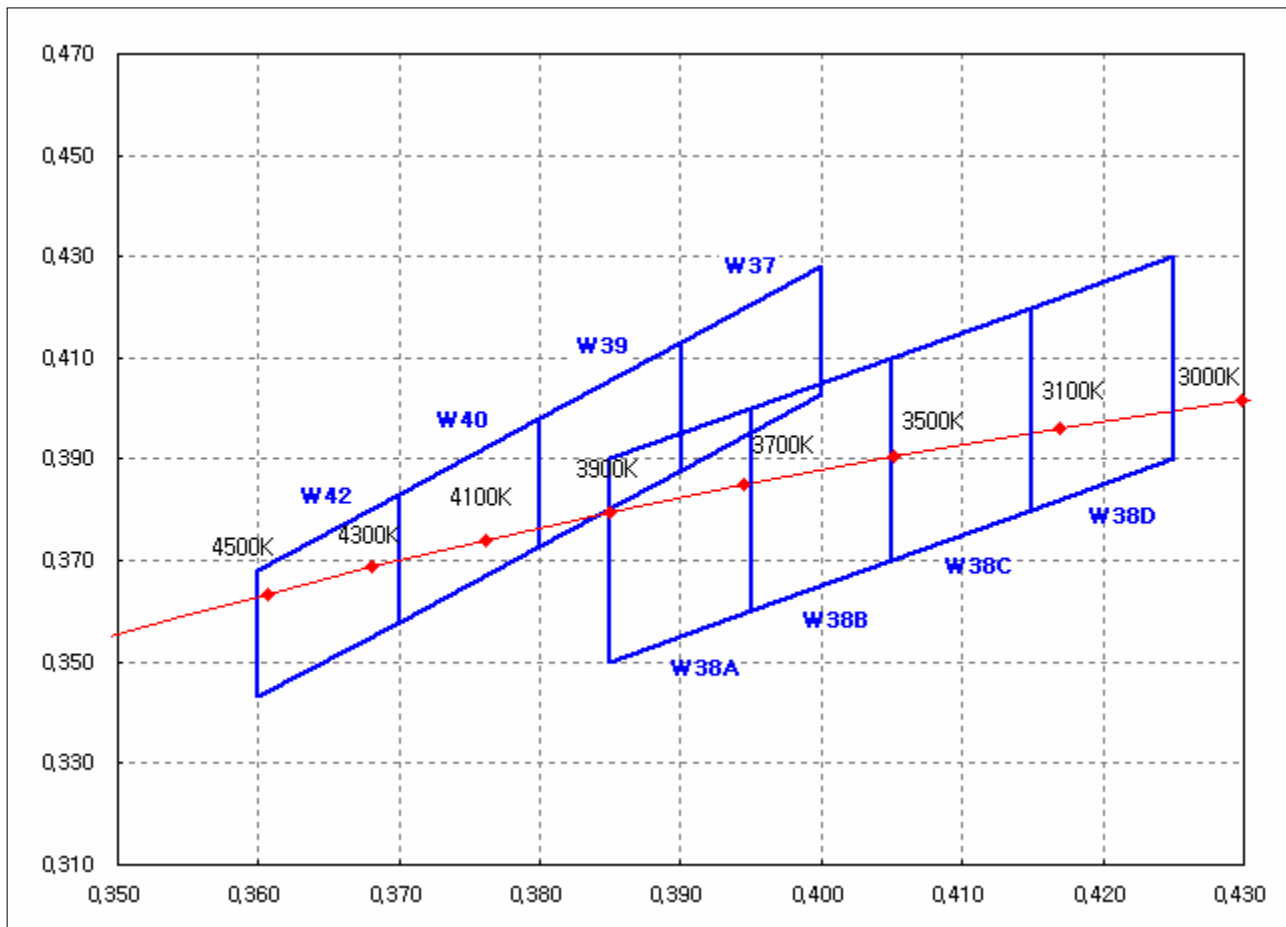

W42		W40		W39		W37	
x	y	x	y	x	y	x	y
0.360	0.343	0.370	0.358	0.380	0.373	0.390	0.388
0.360	0.368	0.370	0.383	0.380	0.398	0.390	0.413
0.370	0.383	0.380	0.398	0.390	0.413	0.400	0.428
0.370	0.358	0.380	0.373	0.390	0.388	0.400	0.403

W38A		W38B		W38C		W38D	
x	y	x	y	x	y	x	y
0.385	0.350	0.395	0.360	0.405	0.370	0.415	0.380
0.385	0.390	0.395	0.400	0.405	0.410	0.415	0.420
0.395	0.400	0.405	0.410	0.415	0.420	0.425	0.430
0.395	0.360	0.405	0.370	0.415	0.380	0.425	0.390

( $T_a=25$  ,  $I_f=20\text{mA}$ )

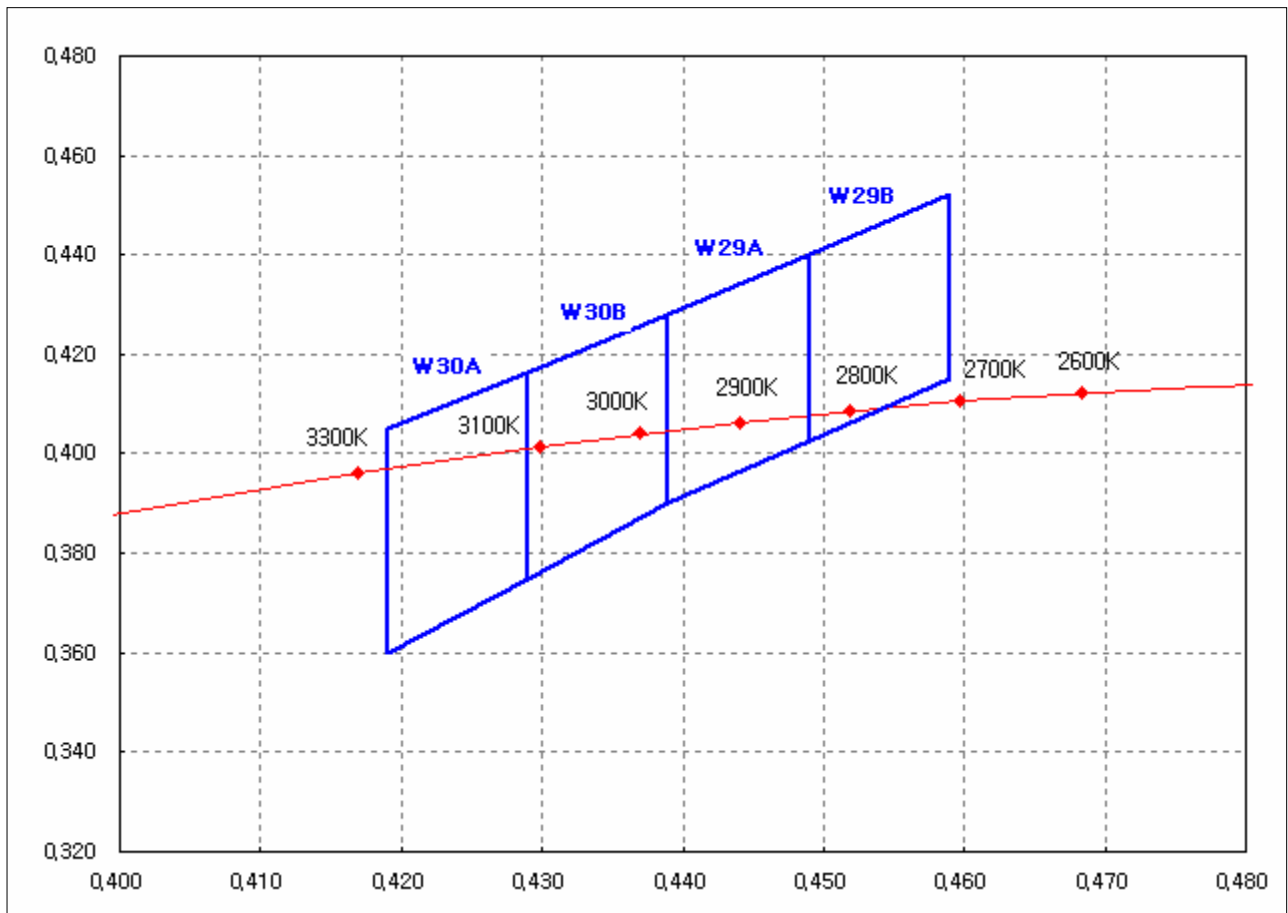

W30A		W30B		W29A		W29B	
x	y	x	y	x	y	x	y
0.4190	0.3600	0.4290	0.3750	0.4390	0.3900	0.4490	0.4025
0.4190	0.4050	0.4290	0.4165	0.4390	0.4280	0.4490	0.4400
0.4290	0.4165	0.4390	0.4280	0.4490	0.4400	0.4590	0.4520
0.4290	0.3750	0.4390	0.3900	0.4490	0.4025	0.4590	0.4150



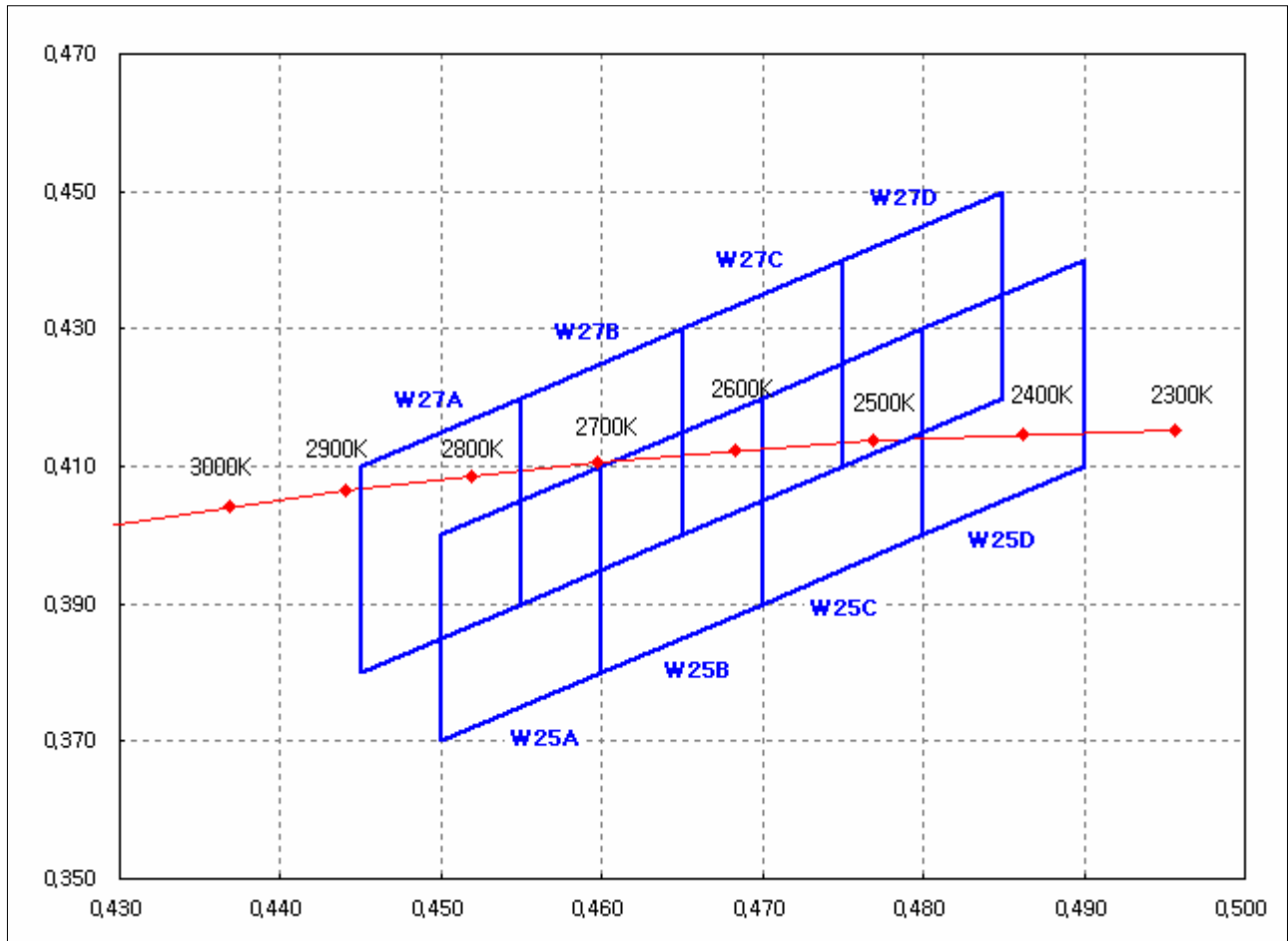

W25A		W25B		W25C		W25D	
x	y	x	y	x	y	x	y
0.450	0.370	0.460	0.380	0.470	0.390	0.480	0.400
0.450	0.400	0.460	0.410	0.470	0.420	0.480	0.430
0.460	0.410	0.470	0.420	0.480	0.430	0.490	0.440
0.460	0.380	0.470	0.390	0.480	0.400	0.490	0.410

W27A		W27B		W27C		W27D	
x	y	x	y	x	y	x	y
0.445	0.380	0.455	0.390	0.465	0.400	0.475	0.410
0.445	0.410	0.455	0.420	0.465	0.430	0.475	0.440
0.455	0.420	0.465	0.430	0.475	0.440	0.485	0.450
0.455	0.390	0.465	0.400	0.475	0.410	0.485	0.420

<sup>5)</sup> The allowance of color coordinates measurement is within  $\pm 0.01$ . (CIE1931 standard colorimetric system)

## 6. Materials

Item	Material
LED chip	InGaN
Wire	Gold
Lead Frame	Copper Alloy/Ni/Ag Plating
Encapsulation	Silicone
Heat-Resistant Polymer	PPA

## 7. Taping

7.1. Tape (Material : PS conductive,  $10^4 \sim 10^5 \Omega$ )

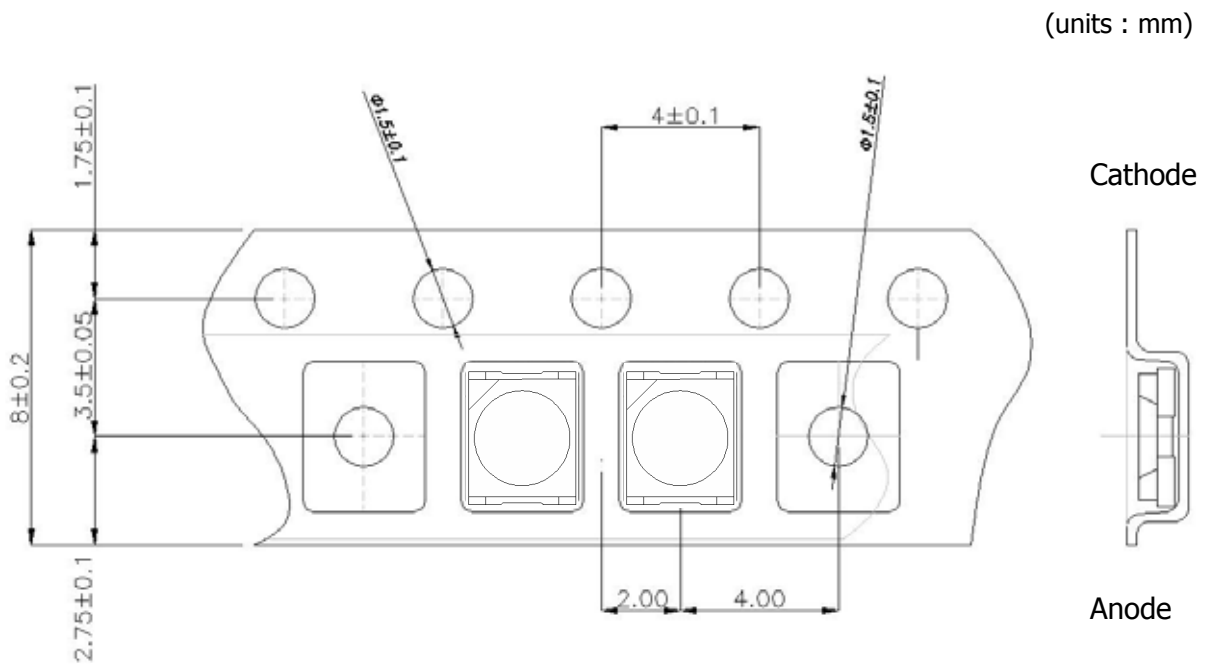

7.2. Wheel (Color : Black, Material : PS conductive,  $10^9 \sim 10^{12} \Omega$ )

(units : mm)

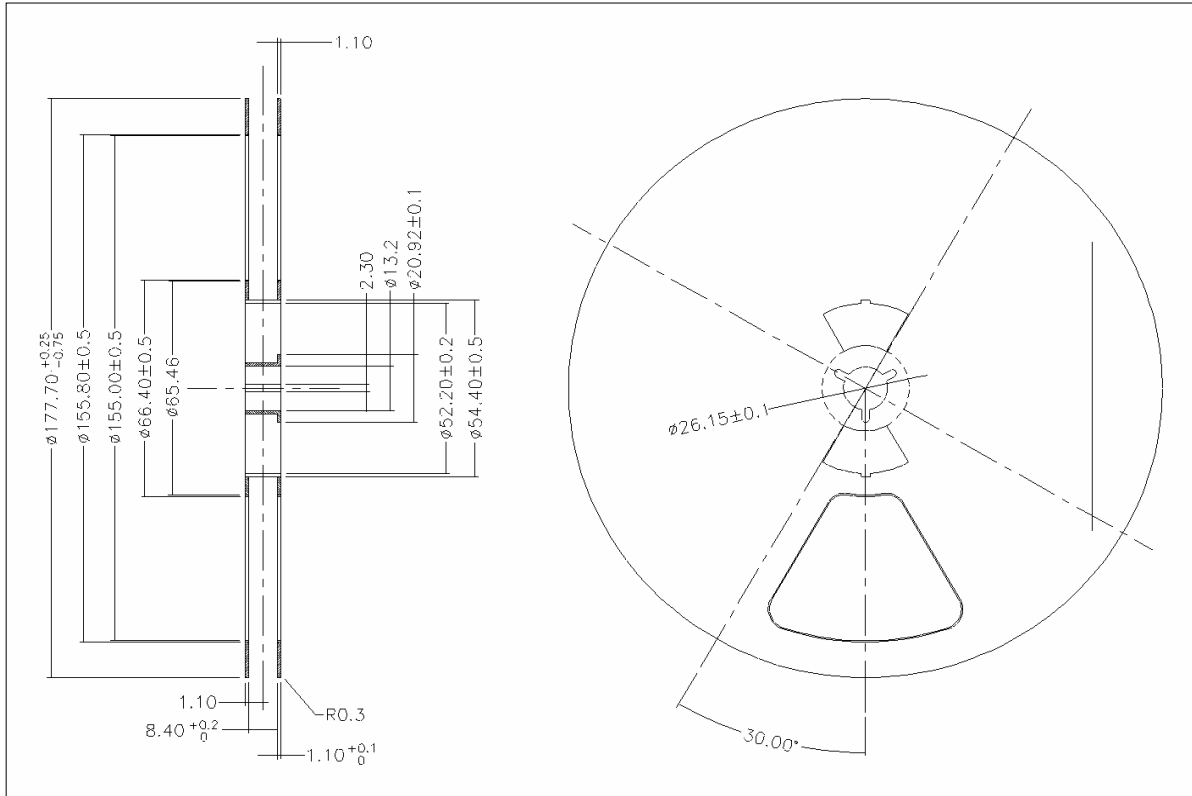

- Quantity Per Reel LWM1035N : 3,000pcs

7.3. Label

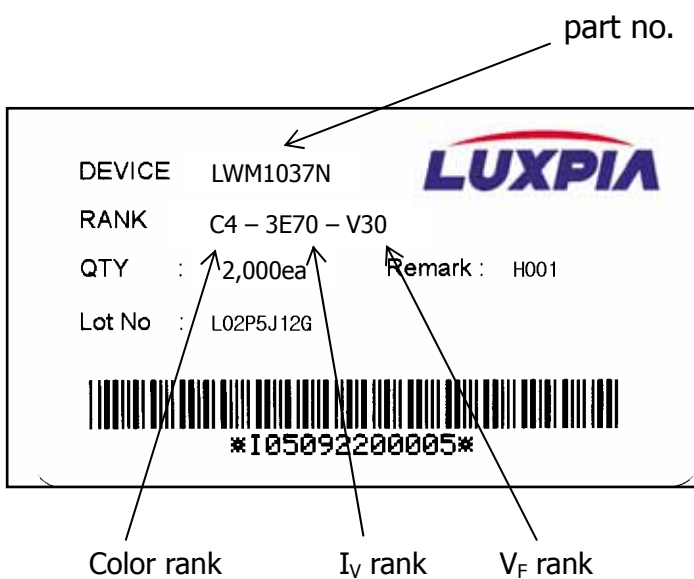

size (L X W) : 85mm × 50mm

## 8. Packing

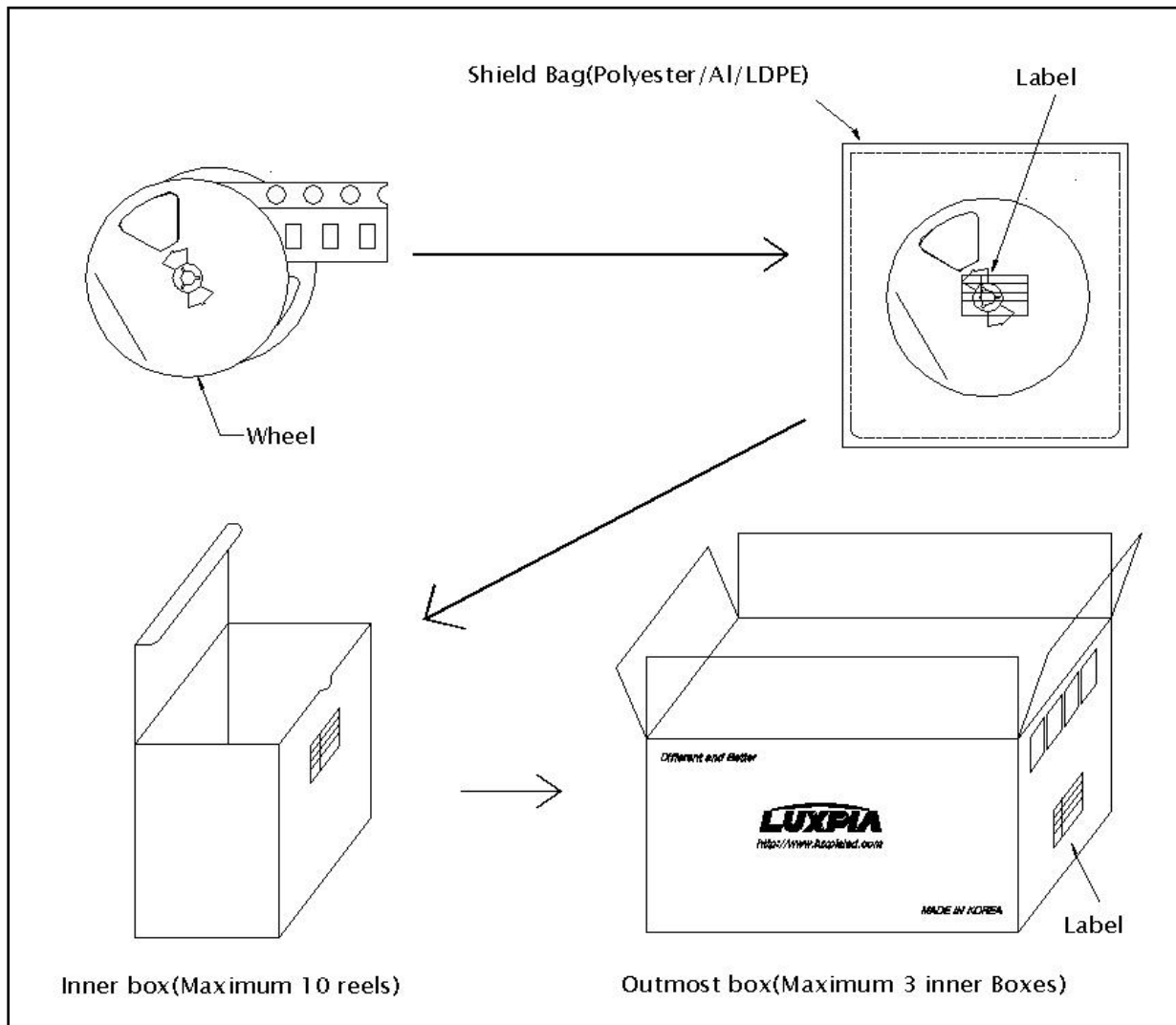

- The LEDs are packed in cardboard boxes after taping. The label shows part number, lot number, rank, and quantity.
- In order to protect the LEDs from mechanical shock, they are packed with cardboard boxes for transportation.
- The LEDs may be damaged if the boxes are dropped or receive a strong impact against them, so cautions must be taken to prevent any possible damage.
- The boxes are not water-resistant and, therefore, must be kept away from water and moisture.
- When the LEDs are transported, it is recommended that the same packing method as Luxpia's is used.
- If noticeable damage on a box appears upon arrival at the user's warehouse, the user should submit a claim to Luxpia within one week after arrival of the products.

## 9. Reliability

### 8.1. Test Items And Results

No.	Test Item	Standard Test Method	Test Conditions	Note	Number Of Damaged Sample
1	Resistance to Soldering Heat (Reflow)	JESD22-B106	$T_{sld}=260^{\circ}\text{C}$ , 10sec (pre treatment $60^{\circ}\text{C}$ ,90%,24hrs)	2 times	0/45
2	Solderability (reflow)	EIAJED4701-200 JESD22-B102	$T_{sld}=215\pm 5^{\circ}\text{C}$ , 3sec	1 time over 95%	0/45
3	Temperature Cycle	EIAJED4701-100 JESD22-A104	$-40^{\circ}\text{C}$ through $+25^{\circ}\text{C}$ to $+100$ (30min/5min/30min)	100 cycles	0/45
4	High Temperature Storage	EIAJED4701-200 JESD22-A103	$T_a=100$	1000 hrs	0/45
5	High Humidity and Temperature Storage	EIAJED4701-200 JESD22-A101	$T_a=60$ , RH=90%	1000 hrs	0/45
6	Low Temperature Storage	EIAJED4701-200 JESD22-A103	$T_a=-40$	1000 hrs	0/45
7	Steady-state Operating Lifetime Test	MIL-STD-883E JESD22-A108	$T_a=25$ , $I_F=60\text{mA}$	500 hrs	0/45
8	Steady-state Operating Lifetime of High Temperature	MIL-STD-883E JESD22-A108	$T_a=85$ , $I_F=7.5\text{mA}$	1000 hrs	0/45
9	Steady-state Operating Lifetime of High Humidity and Temperature	-	$T_a=60$ , RH=90%, $I_F=20\text{mA}$	500 hrs	0/45
10	Steady-state Operating Lifetime of Low Temperature	MIL-STD-810F JESD22-A108	$T_a=-30$ , $I_F=20\text{mA}$	1000 hrs	0/45

\* LED with Luxpia standard circuit board

### 8.2. Criteria for Judging the Damage

Item	Symbol	Test Condition	Criteria for Judgment	
			Min	Max
Forward Voltage	$V_F$	$I_F = 60\text{mA}$	-	U.S.L. <sup>5)</sup> $\times 1.1$
Luminous Intensity	$I_V$	$I_F = 60\text{mA}$	L.S.L. <sup>6)</sup> $\times 0.7$	-

<sup>5)</sup> U.S.L. : Upper Standard Level

<sup>6)</sup> L.S.L. : lower standard level

## 10. Cautions

The LEDs are device which are materialized by combining Blue LEDs and special phosphors. Consequently, the color of White LEDs is subject to change a little by an operating current.

Care should be taken after due consideration when using LEDs.

### (1) Moisture-Proof Package

- When moisture is absorbed into the SMT package it may vaporize and expand products during soldering. There is a possibility that this may cause exfoliation of the contacts and damage to the optical characteristics of the LEDs. For this reason, the moisture-proof package is used to keep moisture to a minimum in the package.

- A package of a moisture-absorbent material (silica gel) is inserted into the shielding bag. The silica gel changes its color from blue to pink as it absorbs moisture.

### (2) Storage

- Storage Conditions

- Before opening the package :

The LEDs should be kept at 5 ~30 or less and 65%RH or less. The LEDs should be used within a year. When storing the LEDs, moisture-proof packaging with moisture-absorbent material (silica gel) is recommended.

- After opening the package :

The LEDs should be kept at 5 ~40 or less and 30%RH or less. The LEDs should be soldered within 168 hours (7 days) after opening the package. If unused LEDs remain, they should be stored in moisture-proof packages, such as sealed containers with packages of moisture-absorbent material (silica gel). It is also recommended to return the LEDs to the original moisture-proof bag and to reseal the moisture-proof bag again.

- If the moisture-absorbent material (silica gel) has faded away or the LEDs have exceeded the recommended storage time, baking treatment should be performed using the following conditions.

- Baking treatment : more than 24 hours at 65±5

- After assembly and during use, silver plating can be affected by the corrosive gases emitted by components and materials in close proximity of the LEDs within an end product, and the gases entering into the product from the external atmosphere. The above should be taken into consideration when designing.

- Please avoid rapid transitions in ambient temperature, especially in high humidity environments where condensation can occur.

### (3) Heat Generation

- Thermal design of the end product is of paramount importance. Please consider the heat generation of the LED when the system is designed. The coefficient of temperature increase per input electric power is affected by the thermal resistance of the circuit board and density of LED placement on the board, as well as other components. It is necessary to avoid intense heat generation and operate within the maximum ratings given in the specification.

- The operating current should be decided after considering the ambient maximum temperature of LEDs.

#### (4) Recommended circuit

- In designing a circuit, the current through each LED must not exceed its absolute maximum rating. It is recommended to use Circuit B which regulates the current flowing through each LED. In the meanwhile, when driving LEDs with a constant voltage in Circuit A, the current through the LEDs may vary due to the variation in forward (VF) of the LEDs. In worst case, some LED may be subjected to stresses in excess of the absolute maximum rating.



- This product should be operated in forward bias. Driving circuit must be designed so that the product is not subjected to either forward or reverse voltage while it is off. In particular, if a reverse voltage is continuously applied to the product, such operation can cause migration resulting in LED damage.
- Please determine the operating current with consideration of the ambient temperature local to the LED and refer to the plot of Ambient temperature vs. Allowable Forward Current on CHARACTERISTICS in this specifications. Please also take measures to remove heat from the area near the LED to improve the operational characteristics of the LED.

#### (5) Handling Precautions

- Bare Hand

When handling the product, touching encapsulant with bare hands will contaminate its surface that could affect optical characteristics. In the worst cases, excessive force on the encapsulant by hands might result in catastrophic failure of the LEDs due to wire deformation and/or breakage.

- Tweezers

Since silicone used as encapsulating resin in this product is a soft material, the upper surface of the product is soft. Pressing onto the product might cause catastrophic failure of the LEDs due to damage to encapsulant (such as scratch, chip-out and delamination) and wire (such as deformation and breakage) and LED detachment.



- Pick and Place

Recommended conditions: Outer nozzle 2.4mm

Avoid direct contact to the encapsulant with the picking nozzle.

Failure to comply might result in damage to encapsulant and in the worst cases, catastrophic failure of the LEDs due to wire deformation and/or breakage.

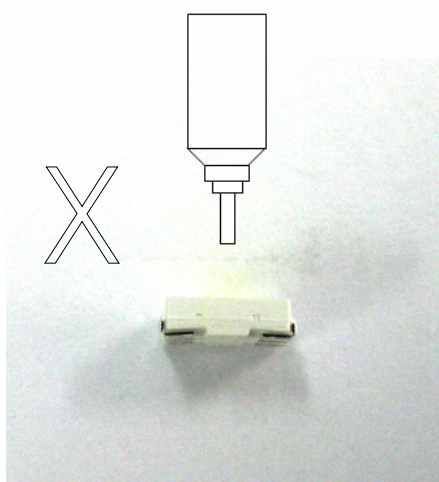

- Drop

Please note that a package damage such as crack might occur when having dropped the product.





- Printed Circuit Board Assembled (PCB with LEDs soldered)

Do not stack assembled PCBs together. Since silicone is a soft material abrasion between two PCB assembled with encapsulate LED might cause catastrophic failure of the LEDs due to damage to encapsulant (such as scratch, chip-out and delamination) and wire (such as deformation and breakage) and LED detachment.

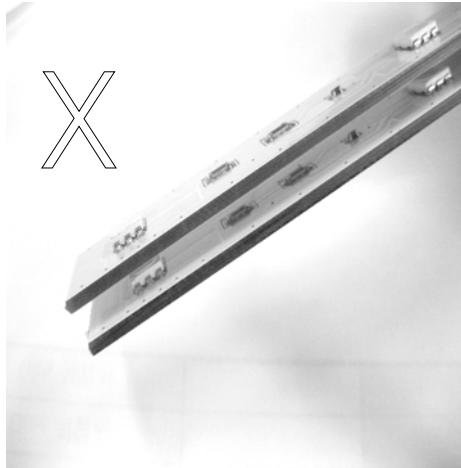

#### (6) Soldering Conditions

- The LEDs can be soldered in place using the reflow soldering method. Luxpia does not make any guarantee on the LEDs after they have been assembled using the dip soldering method.
- Recommended soldering conditions

	Reflow Soldering		Hand Soldering	
	Lead Solder	Lead-free Solder	Temperature	Soldering Time
Pre-Heat	120~150	180~200		
Pre-Heat Time	120sec Max.	120sec Max.		
Peak Temperature	240 Max.	260 Max.		
Soldering Time	10sec Max.	10sec Max.		
Condition	refer to profile	refer to profile		

\* Although the recommended soldering conditions are specified in the above table, reflow soldering at the lowest possible temperature is desirable for the LEDs.

\* A rapid-rate process is not recommended for cooling the LEDs down from the peak temperature.

[Temperature-Profile (surface of circuit board)]

Use the conditions shown to the following figures.

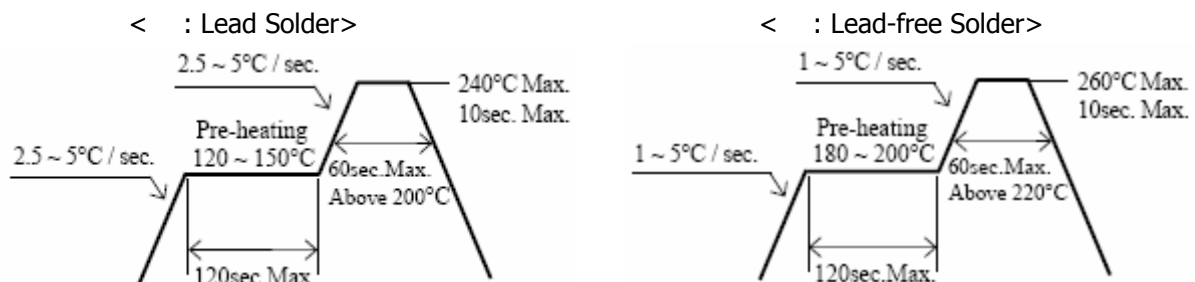

- Occasionally there is a brightness decrease caused by the influence of heat or ambient atmosphere during

air reflow. It is recommended that the User use the nitrogen reflow method.

- Repairing should not be done after the LEDs have been soldered. When repairing is unavoidable, a double-head soldering iron should be used. It should be confirmed beforehand whether the characteristics of the LEDs will or will not be damaged by repairing.
- Reflow soldering should not be done more than two times.
- When soldering, do not put stress on the LEDs during heating.
- After soldering, do not warp the circuit board.

#### (7) Cleaning

- It is recommended that isopropyl alcohol be used as a solvent for cleaning the LEDs. When using other solvents, it should be confirmed beforehand whether the solvents will dissolve the package and the resin or not. Freon solvents should not be used to clean the LEDs because of worldwide regulations. Do not clean the LEDs by the ultrasonic. When it is absolutely necessary, the influence of ultrasonic cleaning on the LEDs depends on factors such as ultrasonic power and the assembled condition. Before cleaning, a pre-test should be done to confirm whether any damage to the LEDs will occur.

#### (8) Static Electricity

- Static electricity or surge voltage damages the LEDs. It is recommended that a wrist band or an anti-electrostatic glove be used when handling the LEDs.
  - All devices, equipment and machinery must be properly grounded. It is recommended that measurements be taken against surge voltage to the equipment that mounts the LEDs.
  - When inspecting the final products in which LEDs were assembled, it is recommended to check whether the assembled LEDs are damaged by static electricity or not. It is easy to find static-damaged LEDs by a light-on test or a  $V_F$  test at a lower current (below 1mA is recommended).
  - Damaged LEDs will show some unusual characteristics such as the leak current remarkably increases, the forward voltage becomes lower, or the LEDs do not light at the low current.
- criteria :  $V_F > 2.0V$  at  $I_F=0.5mA$

#### (9) Others

- This LED complies with RoHS Directive.
- The LED light output is strong enough to injure human eyes. Precautions must be taken to prevent looking directly at the LEDs with unaided eyes for more than a few seconds.
- Flashing lights have been known to cause discomfort in people; you can prevent this by taking precautions during use. Also, people should be cautious when using equipment that has had LEDs incorporated into it.
- The customer not reverse engineer by disassembling or analysis of the LEDs without having prior written consent from Luxpia. When defective LEDs are found, the User shall inform Luxpia directly before disassembling or analysis.
- The warranties of quality set forth herein are exclusive. All previous negotiations and agreements not specifically incorporated herein are superseded and rendered null and void.
- Both parties shall sincerely try to find a solution when any disagreement occurs regarding these specifications.
- These specifications can be revised upon mutual agreement.
- Luxpia understands that the User accepts the content of these specifications, if the User does not return these specifications with signatures within 3 weeks after receipt.
- The LEDs described in the specification are intended to be used for ordinary electronic equipment (such as office equipment, communications equipment, on the applications in which exceptional quality and reliability are required, particularly when the failure or malfunction of the LEDs may directly jeopardize life or health (such as for airplanes, aerospace, submersible repeaters, nuclear reactor control systems, automobiles, traffic control equipment, life support systems and safety devices)

## 11. Warranty

- (1) Luxpia warrants that its LEDs conform to the foregoing specifications and that Luxpia will convey good title to all LEDs sold.
- (2) LUXPIA disclaims all other warranties including the implied warranties of merchantability and fitness for a particular purpose.
- (3) In the event any LED supplied by Luxpia is found not to conform to the foregoing specifications within ninety days of receipt, Luxpia will repair or replace the LED, at Luxpia's discretion, provided that the User (a) promptly notifies Luxpia in writing of the details of the defect (b) ships the LEDs at the User's expense to Luxpia for examination, and (c) the defect is due to the negligence of Luxpia and not mishandling or misuse by the User.
- (4) Luxpia will not take responsibility for any trouble that is caused by using the LEDs at conditions exceeding our specifications.
- (5) These specifications are applied only when a LED stands alone and it is strongly recommended that the User of the LEDs confirms the properties upon assembly. Luxpia is not responsible for failures caused during and after assembling. It will be excepted from the rule if the failure would be caused undoubtedly by Luxpia.
- (6) A claim report stating details about the defect shall be made when returning defective LEDs. Luxpia will investigate the report immediately and inform the user of the results.
- (7) LUXPIA's liability for defective lamps shall be limited to replacement and in no event shall LUXPIA be liable for consequential damage or lost profits.

## 12. Characteristic Diagrams

(1) Forward Voltage vs. Forward Current

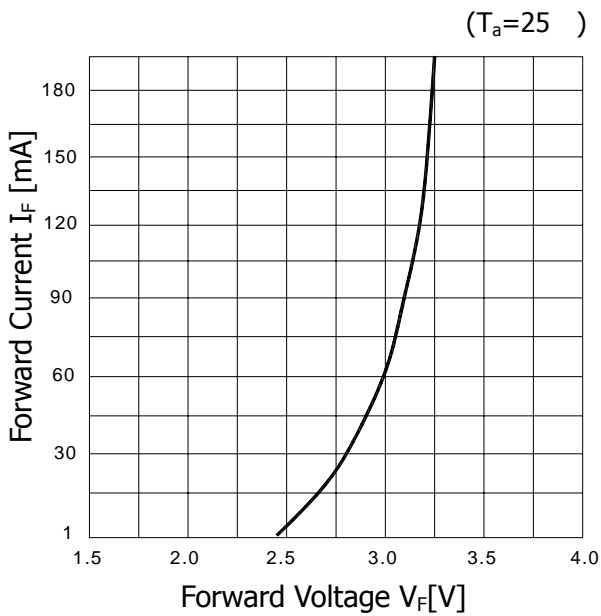

(2) Forward Current vs. Relative Luminosity

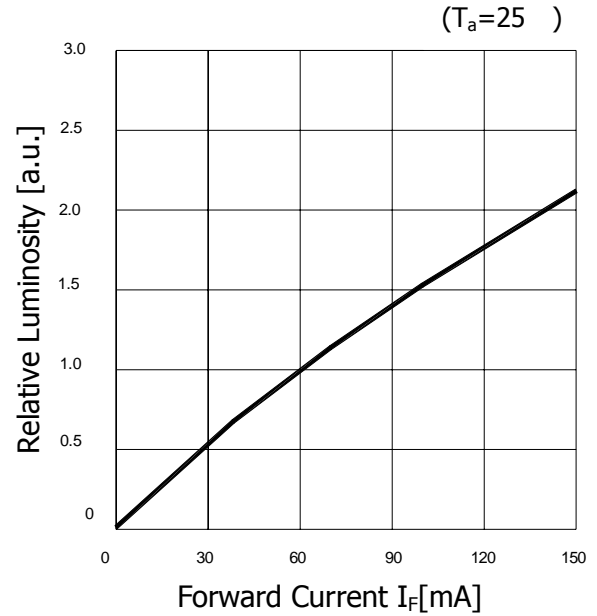

(3) Ambient Temperature vs.  
Allowable Forward Current

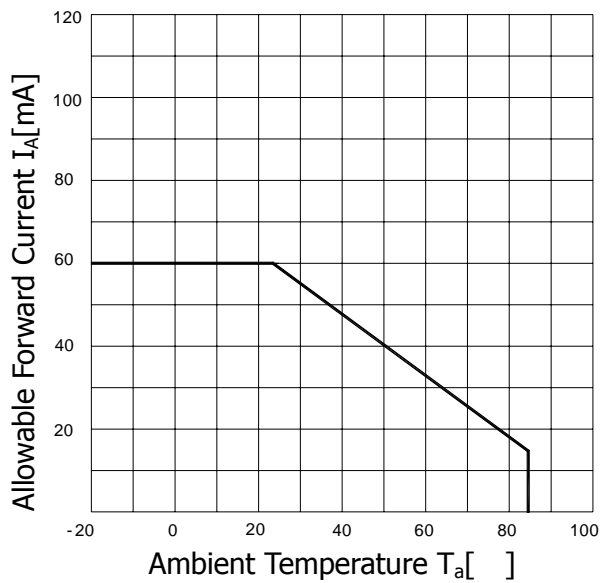

(4) Ambient Temperature vs.  
Relative Luminosity

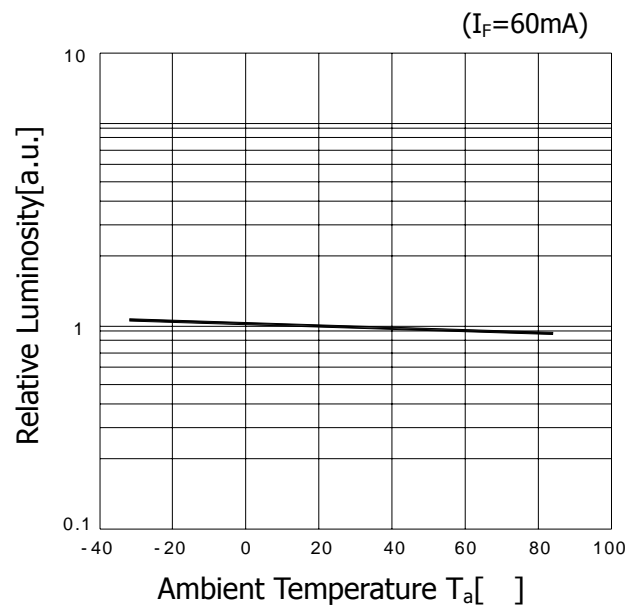

(7) Relative Spectral Emission

$V(\lambda)$  = Standard Eye Response Curve

( $T_a=25$  ,  $I_f=60\text{mA}$ )

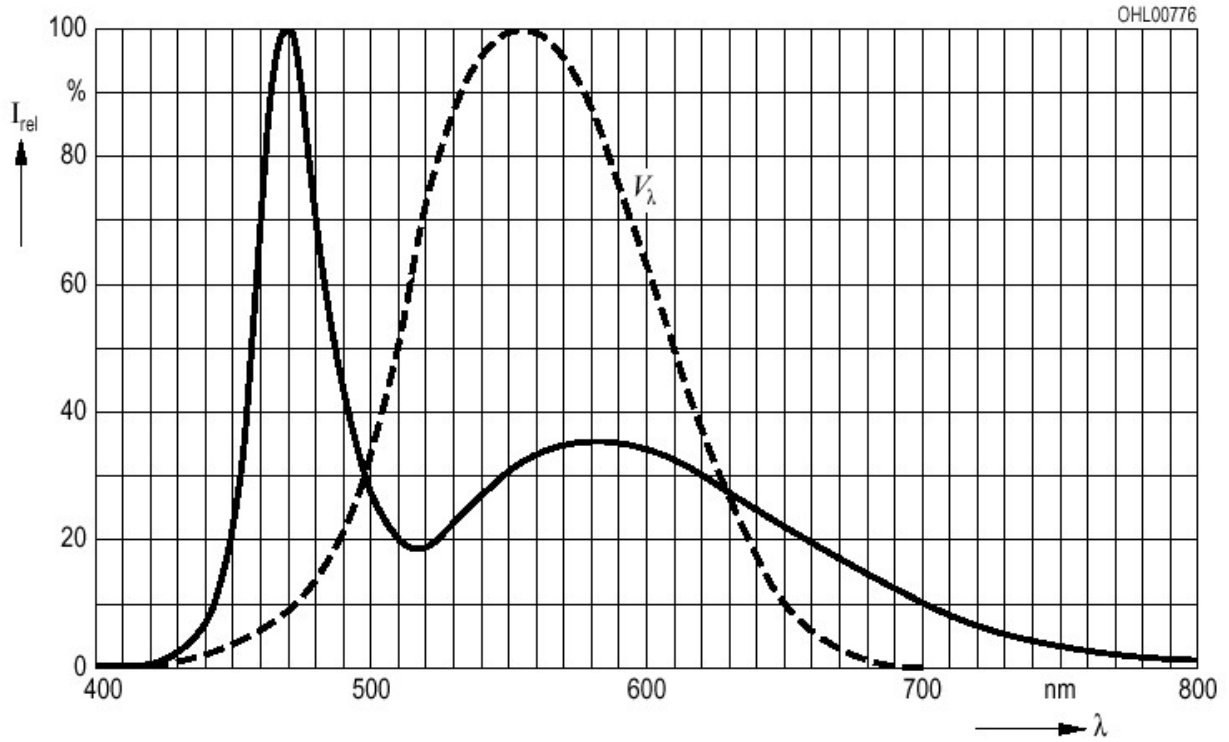

(8) Radiation Characteristics

( $T_a=25$  ,  $I_f=60\text{mA}$ )

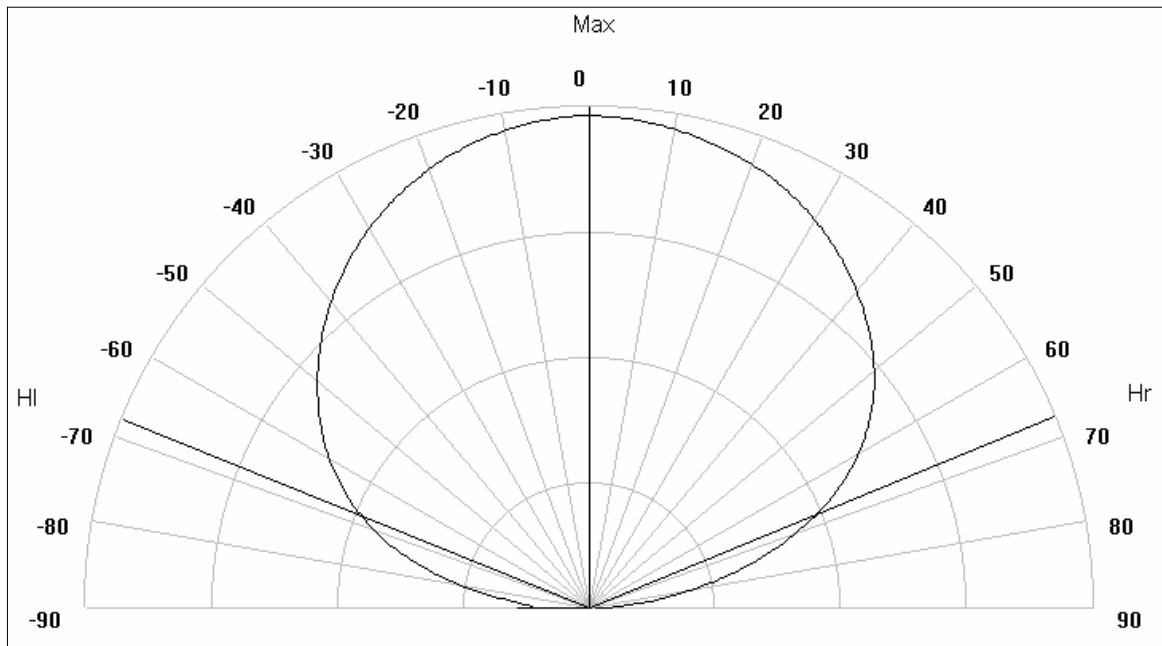

Relative Luminous Intensity  $I_v$  [%]