



Analog Semiconductor IC

HM3033H Series

Low current consumption, 3.0mT High sensitivity
CMOS Hall Magnetic Sensor Switch

(IMPORTANT: Please check the last page for Genuine Product Labeling)

Rev. E13-01

Website: www.anasemi.com
Tel: +852-3590-8442
Email: sales@anasemi.com

AnaSem
..... Future of the analog world



Low current consumption, 3.0mT High sensitivity CMOS Hall Magnetic Sensor Switch

HMX3033H Series

GENERAL DESCRIPTIONS

HMX3033H series are monolithic ICs with built-in Hall magnet sensor element and CMOS switch. It becomes the non-contact switch with low current consumption, high sensitivity and reliability which is combined with magnet.

A vertical magnetic field to the electrode of the package can be detected by an arbitrary polarity. (N pole ⇔ S pole)



FEATURES

- CMOS + Hall monolithic structure
- Low current consumption 5.0μA ($V_{IN}=3.3V$, $T_a=25^{\circ}C$)
- High-sensitivity Typ. 3.0mT
- Operating temperature range $-40 \sim +85^{\circ}C$
- Operating voltage range 1.6V ~ 6.0V
- Detection pulse driving cycle Typ. 50msec with 50μsec width
- Magnetic direction Omnipolar Hall Effect Switch
- Detection magnetic field Vertical direction of marked side of package
(Electrode vertical both direction)
- Small package SOT-23 (2.9×2.8×1.1mm)

APPLICATIONS

- Detection of opening and closing : Mobile phone, Notebook PC, Microwave oven, Washing machine, Rice cooker, Refrigerator, Electronic dictionary, Digital camera, etc.
- Detection of position : Air cylinder, Antitheft window, Digital door lock, etc.
- Detection of water level : Water purifier, Humidifier, Bidet, etc.
- Detection of rotation : Water meter, Gas meter, Wattmeter, Speed meter, etc.
- Power supply switch : Cordless phone, Electric toothbrush, etc.

PRODUCTS NUMBERING GUIDE

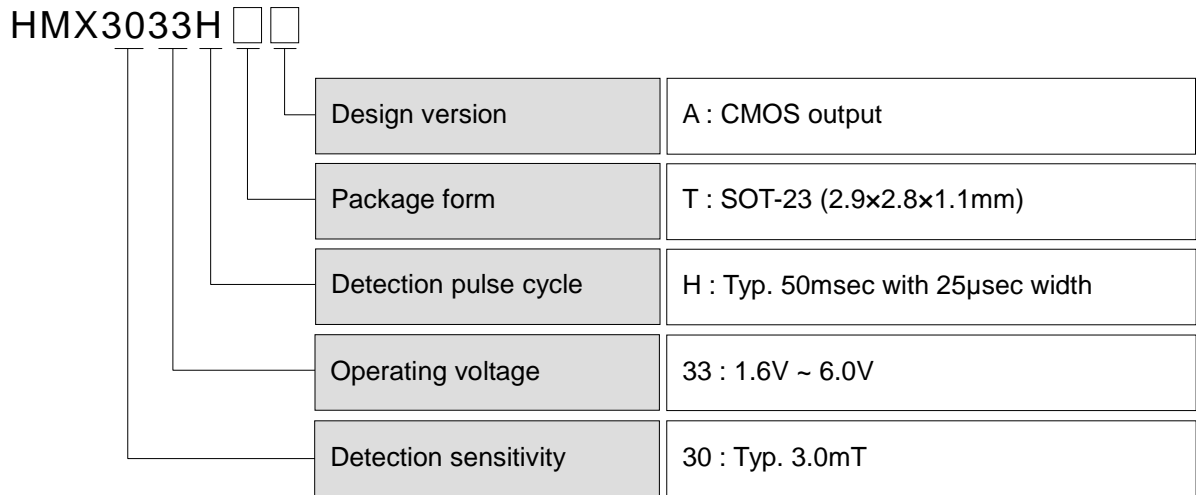

PIN CONFIGURATION / MARKING SPECIFICATION

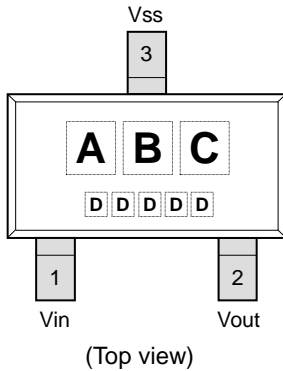

Pin Configuration

No.	Symbol	Descriptions
1	VIN	Voltage input
2	VOUT	Output
3	VSS	Power ground

Marking Specification

Code	Mark	Contents
A	H	Series name
BC	HA	Products specification & version
D	Internal rule	Lot number

BLOCK DIAGRAM

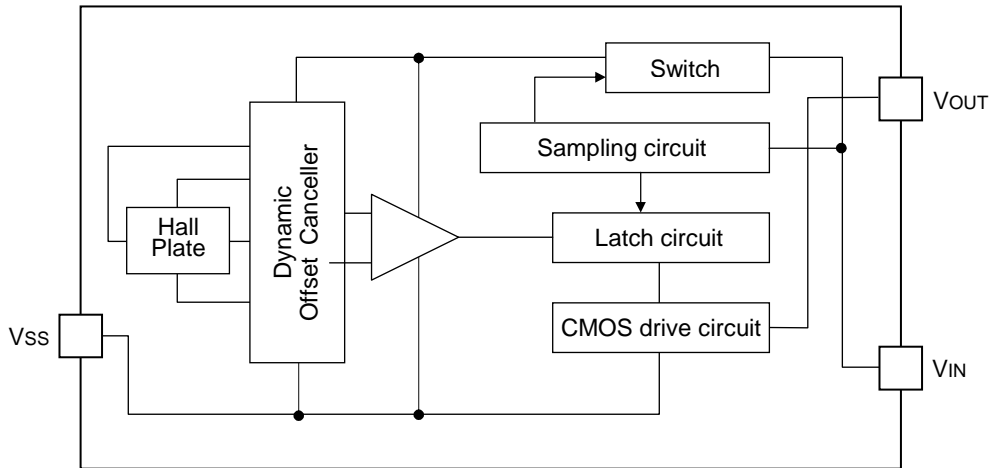

ABSOLUTE MAXIMUM RATINGS

Items	Symbol	Min.	Typ.	Max.	Conditions	Unit
Operating temperature	T _{OPR}	-30	-	+85		°C
Storage temperature	T _{STG}	-40	-	+125		°C
Supply voltage	V _{MAX}	V _{IN} -0.3	-	V _{IN} +7.0		V
Assembly temp. condition	T _{ASY}	-	255	260	t=max:5sec/Tmax	°C

TEST CIRCUIT

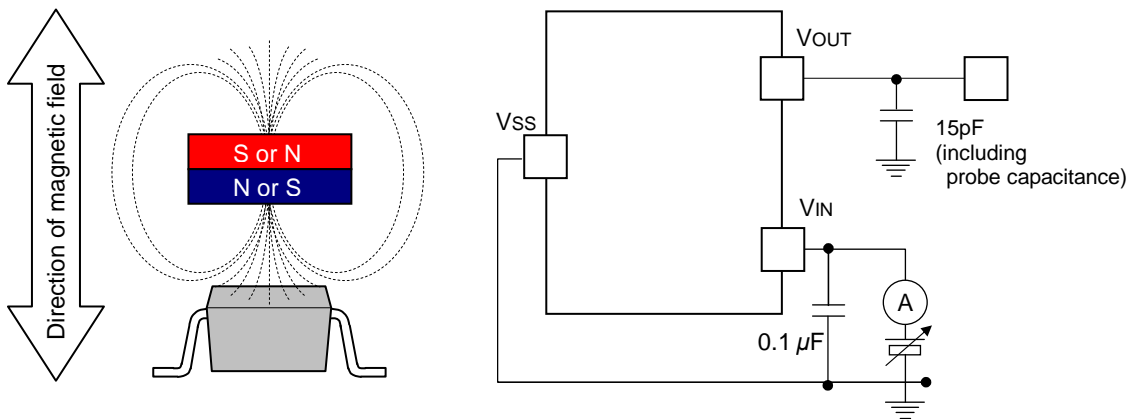

ELECTRICAL CHARACTERISTICS

(Unless otherwise specified, $V_{DD}=3.3V$, $T_a=25^{\circ}C$)

Items	Symbol	Min.	Typ.	Max.	Conditions	Unit
Operating voltage	V_{IN}	1.6	3.3	6.0		V
Current consumption	I_{AVG}	-	5.0	-	Avg. current at $V_{IN}=3.3V$	μA
Detection pulse driving cycle	P_c	-	50	90	Pulse width : 1/1000	msec
"H"-level output voltage	V_{OH}	$V_{IN}-0.4$	-	-	$I_{OH}=-0.5mA$	V
"L"-level output voltage	V_{OL}	-	-	0.4	$I_{OL}=+0.5mA$	V

MAGNETIC CHARACTERISTICS

(Unless otherwise specified, $V_{DD}=3.3V$, $T_a=25^{\circ}C$)

Items	Symbol	Min.	Typ.	Max.	Unit
Magnetic flux density at operating point (H→L)	MBOPS	1.5*	3.0	5.0	mT
	MBOPN	-5.0	-3.0	-1.5*	
Magnetic flux density at release point (L→H)	MBRPS	1.2	2.5	4.7*	mT
	MBRPN	-4.7*	-2.5	-1.2	
Width of hysteresis	MBHYS	0.3*	0.5	1.2*	mT

Note : The values with [*] marks are guaranteed by design, not tested in production.

MAGNETIC-ELECTRIC CONVERSION CHARACTERISTIC

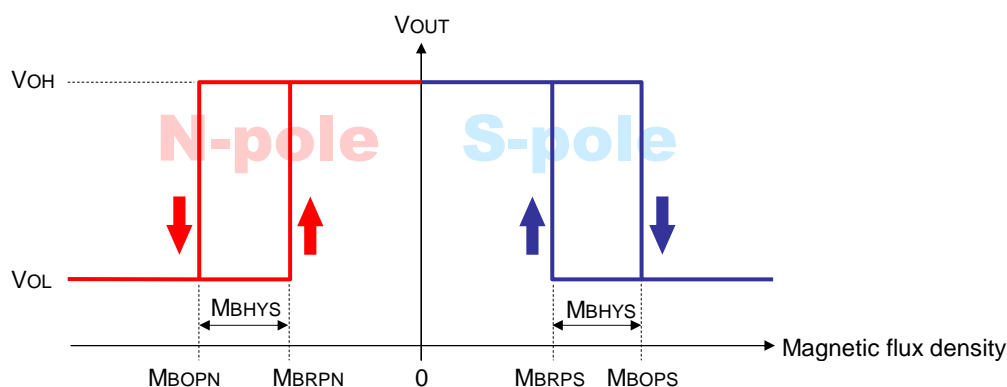

MAGNETIC FLUX DENSITY AND OUTPUT VOLTAGE LEVEL

Conditions		Output level
Magnet & Power	Magnet flux density	
Magnet = OFF / Power = ON	$M = 0\text{mT}$	High-level
Magnet = ON / Power = ON	$M \geq 5.0\text{mT}$	Low-level
Magnet = OFF / Power = ON	$M \leq 1.2\text{mT}$	High-level

DETECTION PULSE DRIVING CYCLE (SAMPLING CYCLE)

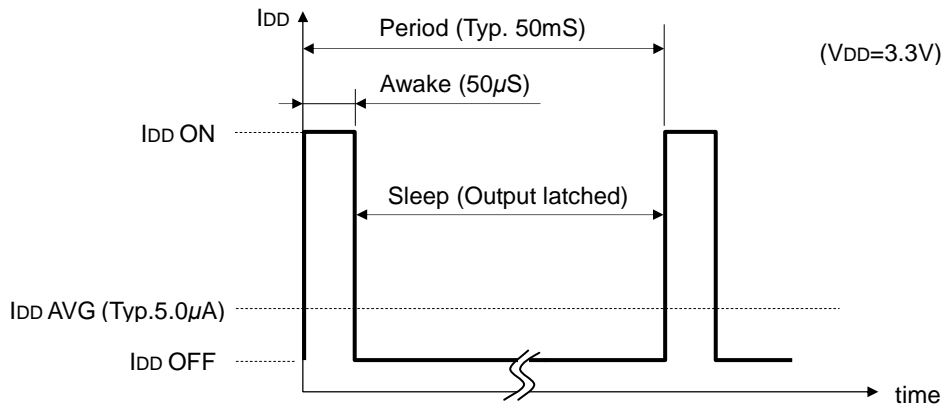

OUTPUT SWITCHING TIMING CHART

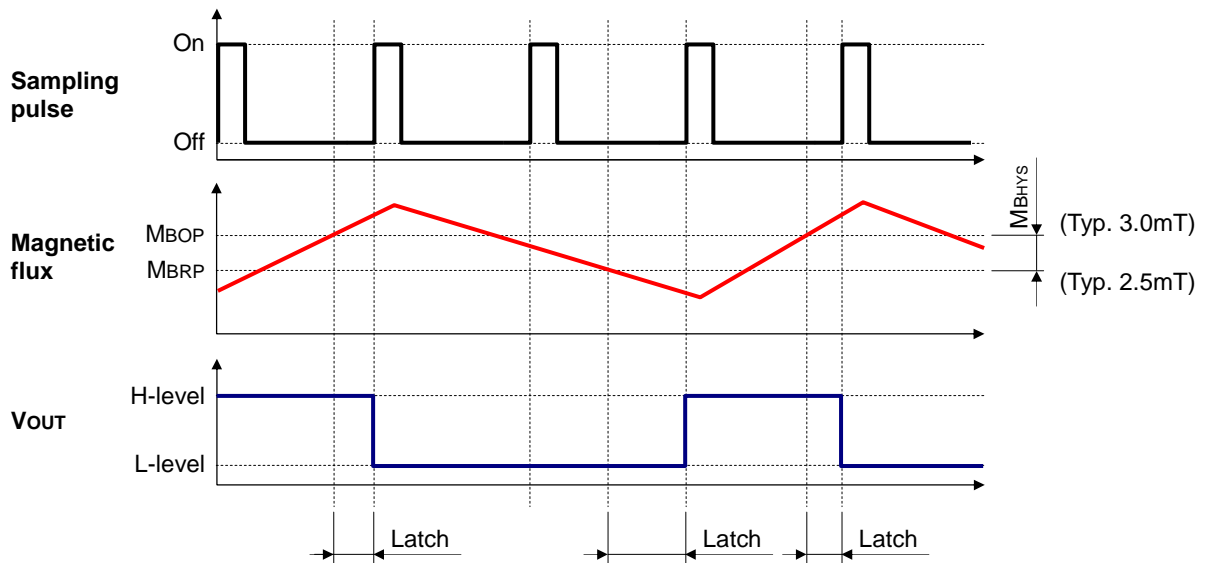

TYPICAL ELECTRIC CHARACTERISTICS

● **Magnetic flux density vs. Input voltage**

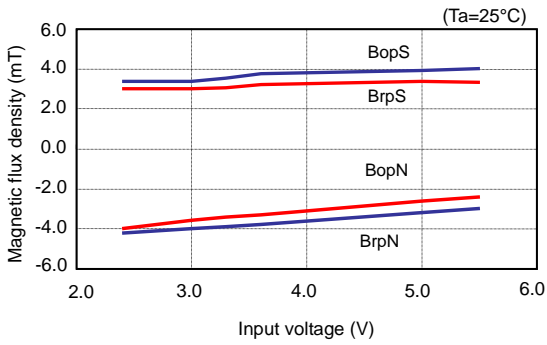

● **Magnetic flux density vs. Ambient temp.**

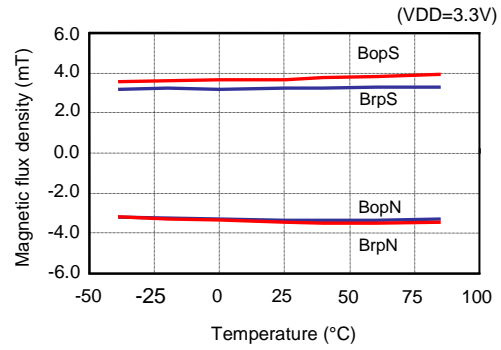

● **Current consumption vs. Input voltage**

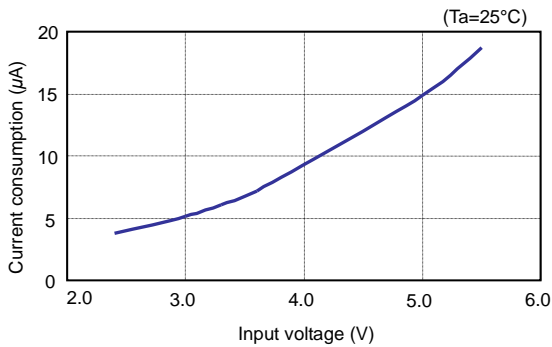

● **Current consumption vs. Ambient temp.**

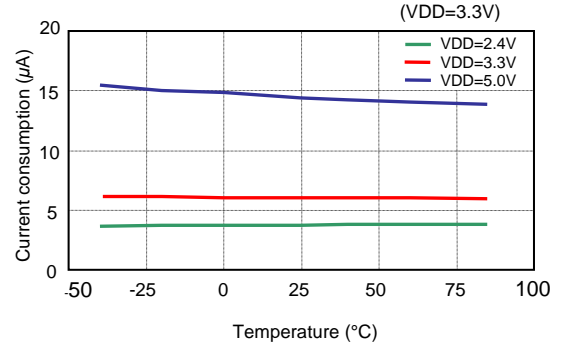

● **Sampling period vs. Input voltage**

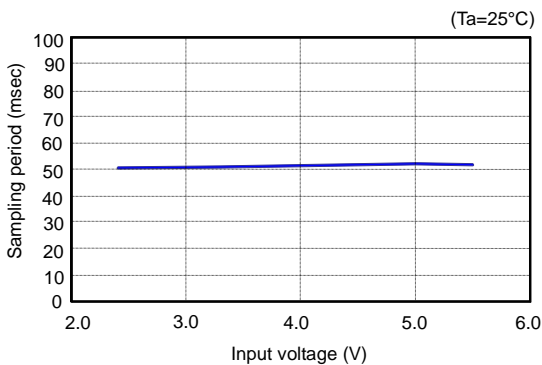

● **Sampling period vs. Ambient temp.**

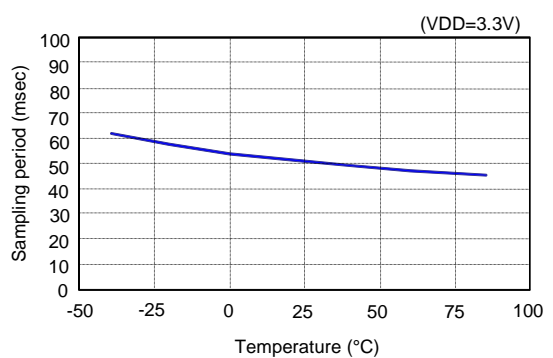

PACKAGE DIMENSIONS (SOT-23)

(Unit : mm)

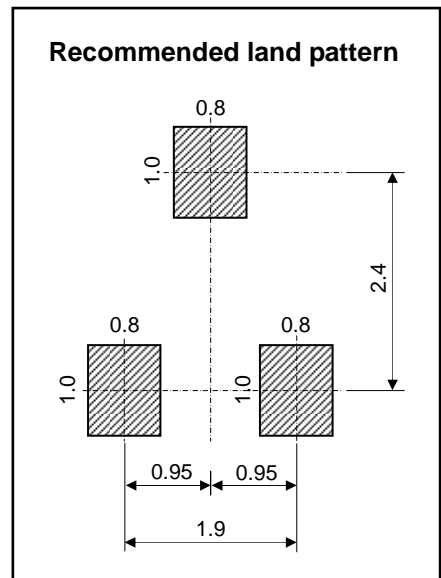
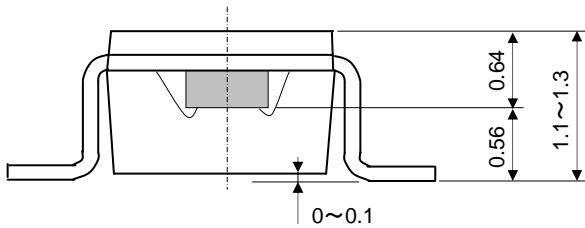
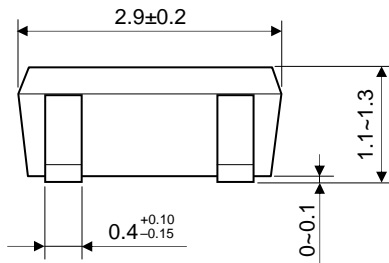
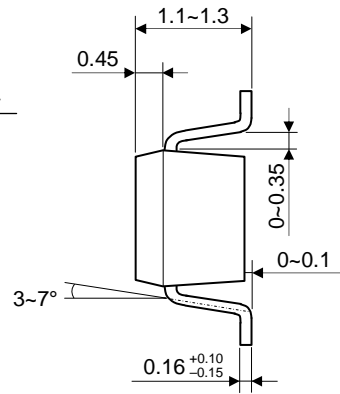
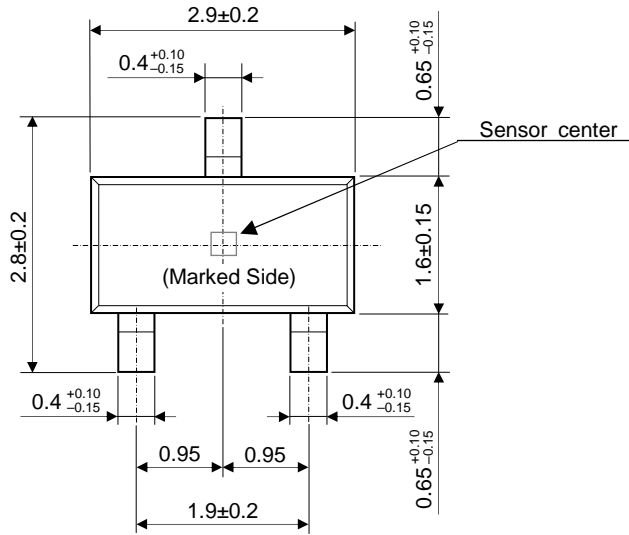

TAPING AND LOADING SPECIFICATIONS (SOT-23)

(Unit : mm)

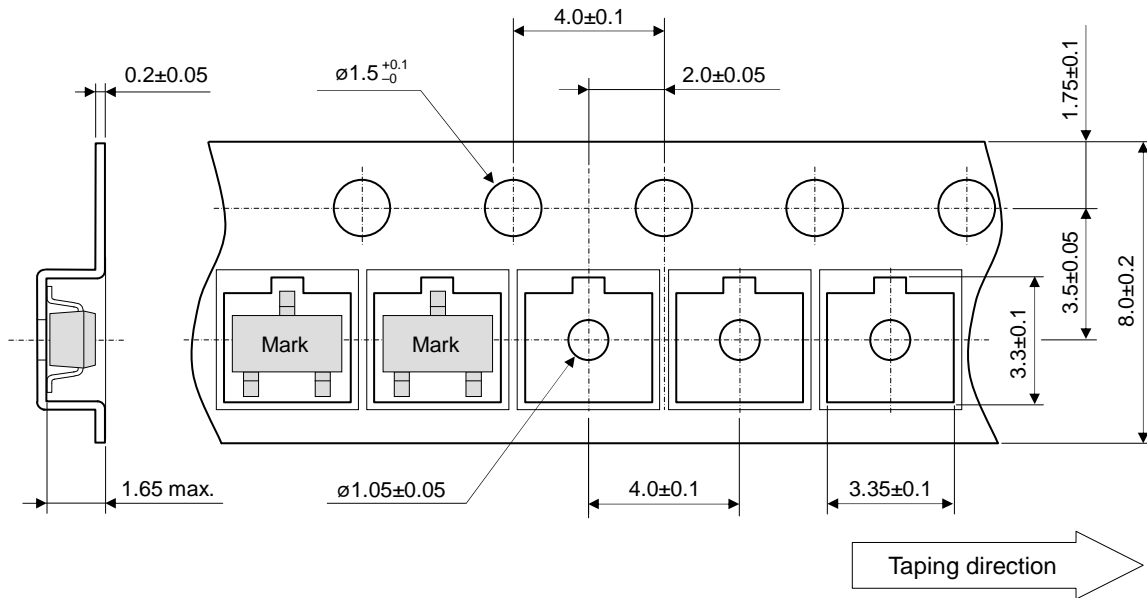

REEL DIMENSIONS (SOT-23)

(Unit : mm)

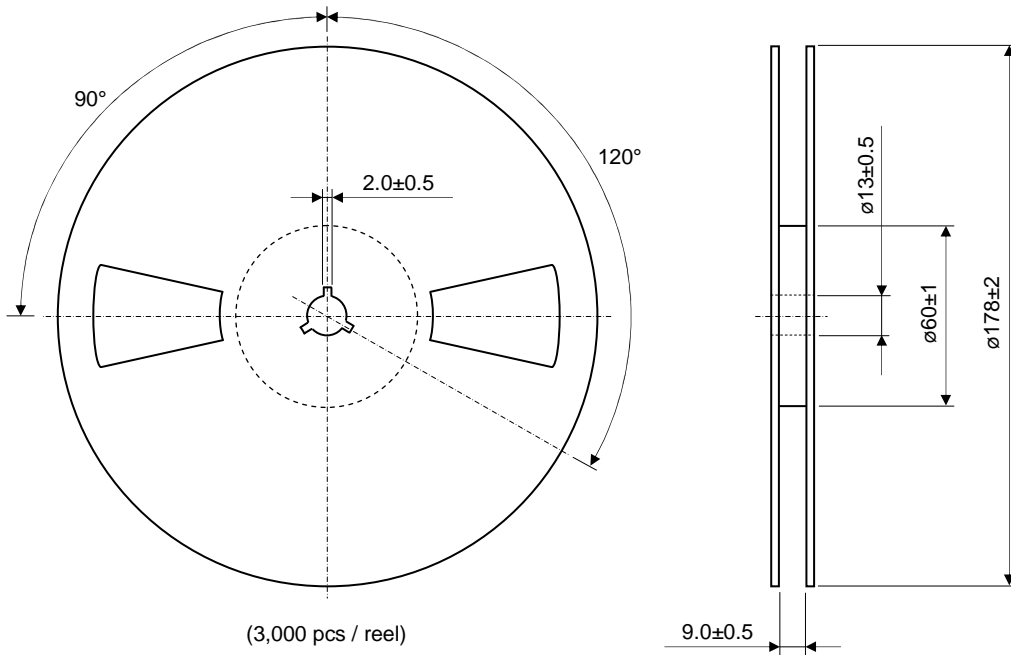

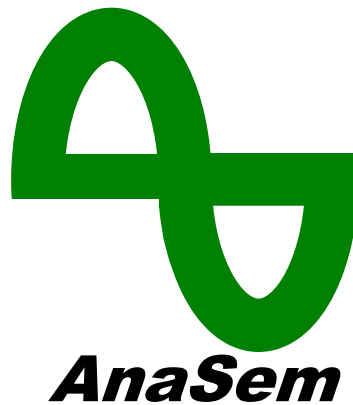

AnaSem may change the products described in this data sheet, or may discontinue production or services without any notice in order to supply the best products through improve the design and performance. Customers are recommended to obtain the latest data or information before placing orders in order to make sure the data or information required is the newest. It is necessary for customers to fully understand the products described in this data sheet and to use it in accordance with its specifications. The products described in this data sheet are not intended to use for the apparatus which have influence on human lives due to the failure or malfunction of the products. AnaSem Corp. is not responsible for any support to customer's application, product design, software performance, patent infringement or service. AnaSem Corp. does not disclose or imply a guarantee or description about being licensed based on patents, copy-rights, circuit location license, or other intellectual properties associated with the devices or combinations in which the products or service of AnaSem Corp. are used or can be used, or which cover the methods. Customers should not export, directly or indirectly, any products without obtaining required licenses and approvals in advance from appropriate government agencies.

AnaSem

www.anasemi.com

sales@anasemi.com

GENUINE PRODUCT LEGITIMATE LABEL DEFINITION

