

End-to-End Embedded Power

2011 Product Selection Guide

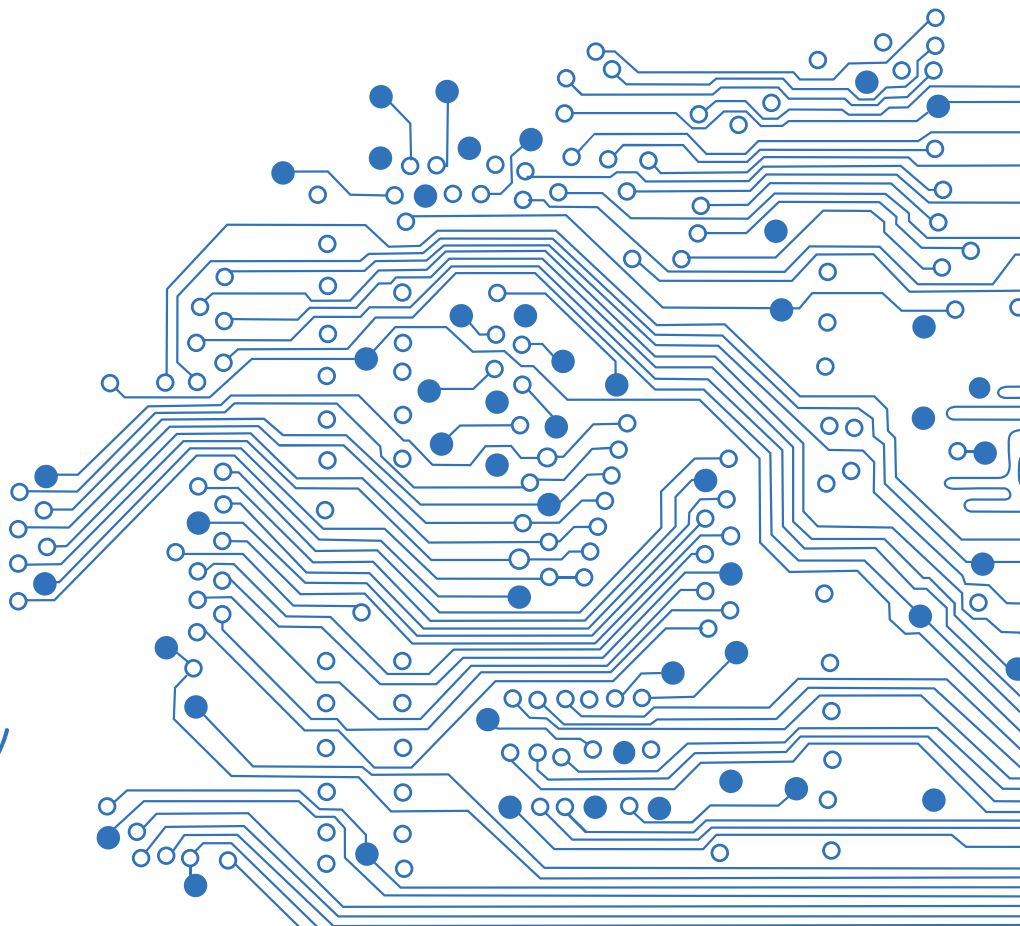

GE Energy



End-to-End Power Solutions

Hybrid Architecture:

≈81% overall efficiency

STRENGTHS:

- Large installed base
- Supports SELV systems
- Battery back-up systems
- Flexibility
- Increased value at lower power
- Optimized for battery operated systems

WEAKNESSES:

- di/dt of isolated bricks less than POLs
- Increased costs for multiple isolation points
- Multiple conversion steps

Intermediate Bus Architecture:

≈84% overall efficiency

STRENGTHS:

- Flexibility (bus voltage options)
- Multiple high di/dt loads
- Provides ground isolation
- Competitive cost
- Increased efficiencies
- Increased power densities

WEAKNESSES:

- Lowest efficiency - 3 conversion stages
- Lowest power density
- Multiple conversion steps

AC to 12V Bus Architecture:

≈87% overall efficiency

STRENGTHS:

- Highest efficiency
- Best power density
- Improved EMI performance
- Lowest cost

WEAKNESSES:

- Circulating current issues
- Higher I²R losses
- Few battery back-up options
- No secondary grounds

Front Ends & Rectifiers

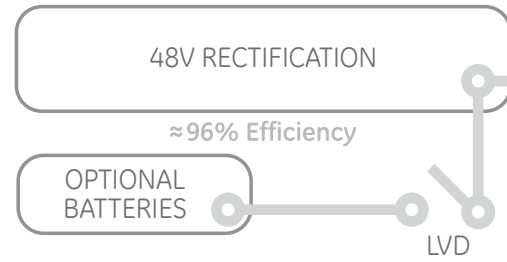
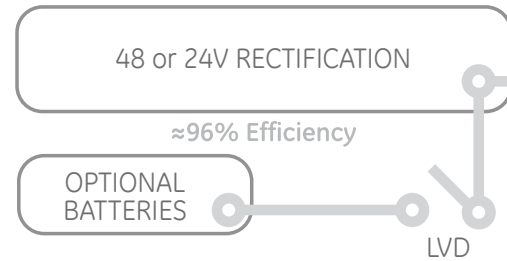

DESCRIPTION	PAGE(S)
Additional Info	11-12, 27-30
Remote Power	11
Compact PCI	12
Digital Converters	25
Industry Solutions	26
Custom Capabilities	27-28
Engineering Resources & Tools	29
Company Profile	30

DESCRIPTION	PAGE(S)
Front End / Rectifiers	3-10
12V Front Ends	6
<i>850-2,500 Watts</i>	
24V & 48V Front Ends	7
<i>500-4,000 Watts</i>	
24V & 48V Rectifiers	8
<i>1,200-4,000 Watt</i>	
Power Shelves	9
<i>6,000-12,000 Watts</i>	
Energy Systems	10
<i>1,600-10,900 Watts</i>	

Lineage Power provides a competitive edge with end-to-end power solutions that offer size, efficiency and cost advantages while dramatically reducing risk with standards-based power components.

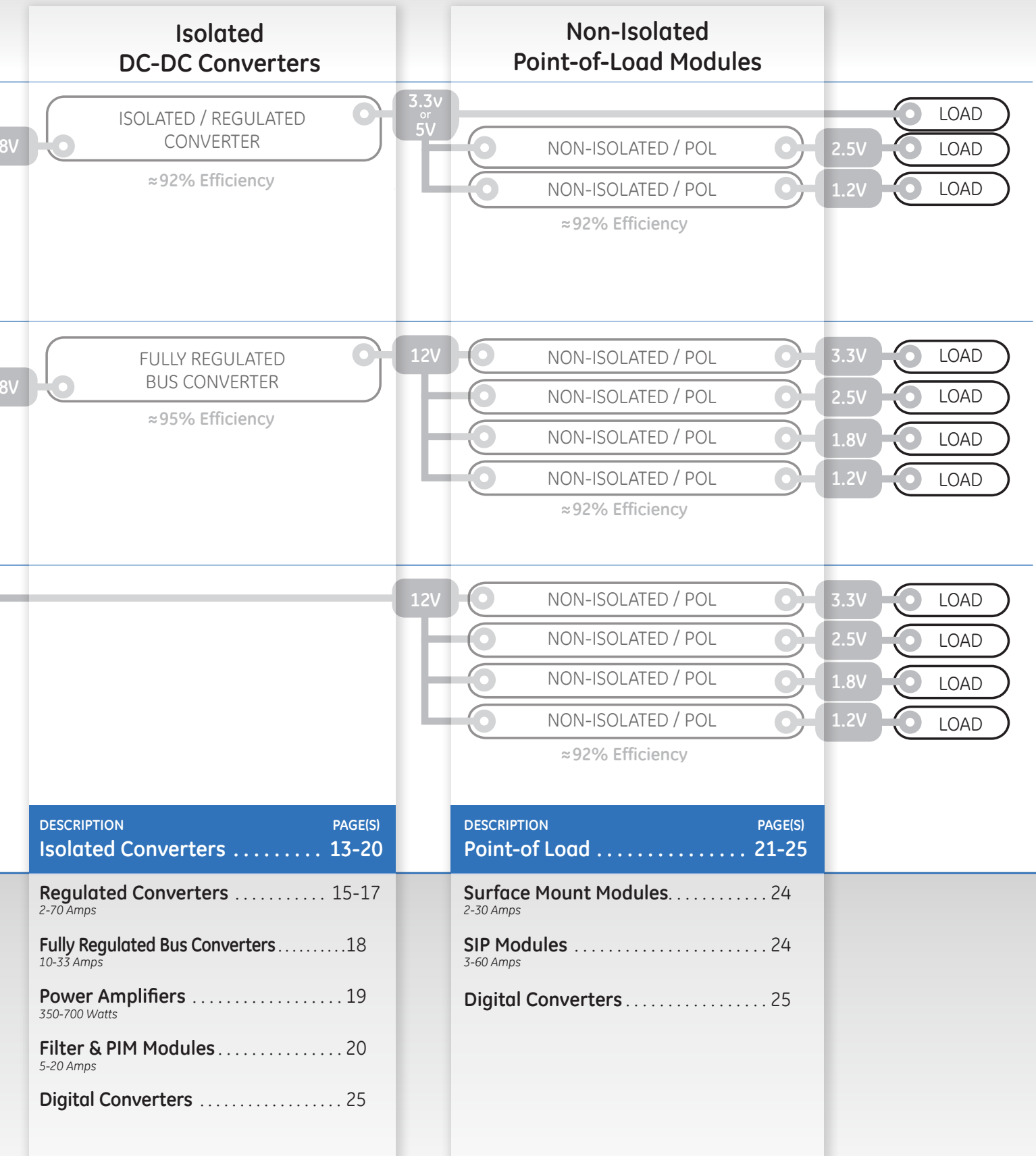

DESCRIPTION	PAGE(S)
Isolated Converters	13-20
Regulated Converters	15-17
<i>2-70 Amps</i>	
Fully Regulated Bus Converters	18
<i>10-33 Amps</i>	
Power Amplifiers	19
<i>350-700 Watts</i>	
Filter & PIM Modules	20
<i>5-20 Amps</i>	
Digital Converters	25

DESCRIPTION	PAGE(S)
Point-of Load	21-25
Surface Mount Modules	24
<i>2-30 Amps</i>	
SIP Modules	24
<i>3-60 Amps</i>	
Digital Converters	25

Front End & Rectifier Solutions

Total Cost of Ownership	5
12V Front Ends	6
24V & 48V Front Ends	7
24V & 48V Rectifiers	8
Power Shelves	9
Energy Systems	10

Product Matrix:

	MODEL	NOMINAL OUTPUT	DIGITAL COMM.	PROFILE	NOMINAL INPUT RANGE	MAXIMUM OUTPUT POWER	500W	1000W	1500W	2000W	2500W	3000W	3500W	4000W
12V Front Ends Page 6	CAR0812FP	12V	I2C /PMBus	1U	1Φ (110/220 VAC)	850W	█							
	CAR1212FP	12V	I2C /PMBus	1U	1Φ (110/220 VAC)	1200W	█	█						
	CAR1212DC	12V	I2C /PMBus	1U	48VDC	1200W	█	█						
	CAR1612FP	12V	I2C /PMBus	1U	1Φ (110/220 VAC)	1600W	█	█	█					
	CAR2512DC	12V	I2C /PMBus	1U	48VDC	2500W	█	█	█	█				
	CAR2512FP	12V	I2C /PMBus	1U	1Φ (110/220 VAC)	2500W	█	█	█	█				
24/48V Front Ends Page 7	CAR1248FP	48V	I2C /PMBus	1U	1Φ (110/220 VAC)	1200W	█	█						
	CAR2024FP	24V	I2C /PMBus	1U	1Φ (110/220 VAC)	2000W	█	█	█					
	CAR2548FP	48V	I2C /PMBus	1U	48VDC	2500W	█	█	█	█				
	CAR2548DC	48V	I2C /PMBus	1U	48VDC	2500W	█	█	█	█				
	CAR3000	24 / 48V	I2C	3U	1-3Φ (220 VAC)	3000W	█	█	█	█	█			
	CAR4000	24 / 48V	I2C	3U	1 or 3Φ (220 VAC)	4000W	█	█	█	█	█	█		
24/48V Rectifiers Page 8	EP1000_U	48V	RS485	1U	1Φ (110/220 VAC)	1000W	█	█						
	CAR1248TN	48V	I2C /PMBus	1U	1Φ (110/220 VAC)	1200W	█	█						
	CP2000DC54	48V	I2C	1U	48VDC	2000W	█	█	█					
	CP2000	48V	I2C /RS485	1U	1Φ (110/220 VAC)	2000W	█	█	█					
	CAR2548TN	48V	I2C /PMBus	1U	1Φ (110/220 VAC)	2500W	█	█	█	█				
	CP2725TE	48V	I2C /RS485	1U	1Φ (110/220 VAC)	2725W	█	█	█	█	█			
	CAR3000T	24 / 48V	I2C	3U	1 or 3 Φ (220 VAC)	3000W	█	█	█	█	█	█		
	CAR4000T	24 / 48V	I2C	3U	1 or 3 Φ (220 VAC)	4000W	█	█	█	█	█	█	█	



Featured Product:
CAR1612FP Front End

- 12VDC output
- 1,600 watts
- High efficiency operation
 - 92.4% @ 20% load
 - 94.5% peak efficiency
- High power density of 20W/in³
- 12.45 x 4.00 x 1.65" / 316.2 x 101.6 x 41.9mm
- I²C / PMBus™ digital interface



Total Cost of Ownership

Our Customers are pressed to meet the growing demands for energy conservation and space reduction within their markets. Rising power costs, expensive cooling strategies in the Data Center, and precious real estate are of paramount concern. It's a question of **Total Cost of Ownership**. Our customers are asking:

- How can we increase end-to-end efficiency?
- How can we reduce our footprints?
- How can we dissipate less heat?

GE Energy has released several new power platforms that extend our offering while providing leading operational efficiencies in high-density packages to address these growing demands. Our front ends & rectifiers offer leading edge performance:

- Power density in excess of 30W/in³
- >10 kilowatts in a 1U / 19" rack-mount shelf
- 12V / 1 U high front-end with 2500 watts of power
- >92% efficiencies starting at only 20% load

Save space, power consumption and generate less heat. GE Energy offers a complete range of high-efficiency/high-density power solutions reducing your system's Total Cost of Ownership.

Size Premium:

Increasing performance while available system space continually shrinks

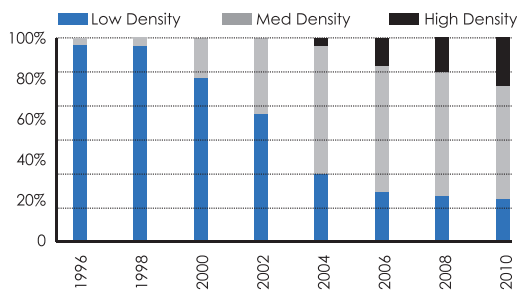

Temperature Rising:

Cooling costs outpace server costs due to increased loads in higher densities

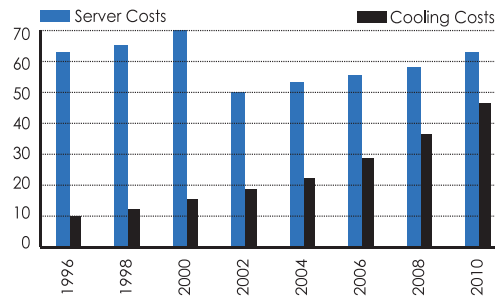

Total-Cost of Ownership Reduction

Server Class	Volume	Lifetime Energy Saving per Server (kWh)	
Silver	Volume	480 - 1290	
	Standard	Mid-Range	1932 - 3366
	High-End	21716 - 36000	
Gold	Volume	740- 1800	
	Standard	Mid-Range	2680- 4710
	High-End	30336- 50742	

* Energy cost are 8.8 cents per kWh (per EPA)
 * Data Center PSU Loaded at 20% of rated power

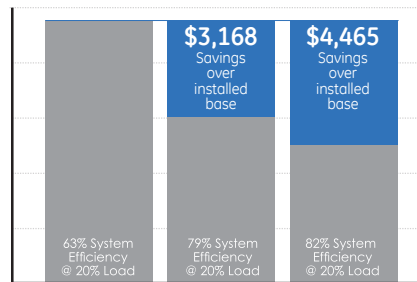

Life Time Savings of High End Server (6 yrs)

Savings are calculated using data from the 80 Plus® Server Project. GE Energy products would enable system designs to exceed the '80 Plus Gold Standard' yielding increased Total Cost of Ownership reduction.

NEW!

CAR0812FP

80 PLUS GOLD



- 850 watts / 12Vout
- Efficiency of 90% @ 20% load (92% peak)
- Power density of 18W/in³
- Universal AC input range with active PFC
- 8.73 x 3.38 x 1.65" / 221.7 x 85.9 x 41.9mm
- I²C / PMBus™ digital interface



CAR1212FP



- 1,200 watts / 12Vout
- High efficiency operation - up to 89%
- Power density of 16W/in³
- Universal AC input range with active PFC
- 11.20 x 4.00 x 1.65" / 284.5 x 101.6 x 41.9mm
- I²C / PMBus™ digital interface



NEW!

CAR1212DC

48Vin



- 1,200 watts / 12Vout
- 36-75VDC input range
- High efficiency operation - up to 90%
- Power density of 16W/in³
- 11.20 x 4.00 x 1.65" / 284.5 x 101.6 x 41.9mm
- I²C / PMBus™ digital interface



NEW!

CAR1612FP

80 PLUS PLATINUM



- 1,600 watts / 12Vout
- Efficiency of 92.4% @ 20% load (94.5% Peak)
- Power density of 20W/in³
- Universal AC input range with active PFC
- 12.45 x 4.00 x 1.65" / 316.23 x 101.6 x 41.9mm
- I²C / PMBus™ digital interface



CAR2512DC

48Vin



- 2,500 watts / 12Vout
- 36-75VDC input range
- High efficiency operation - up to 92%
- Power density of 25W/in³
- 15.38 x 4.00 x 1.65" / 390.5 x 101.6 x 41.9mm
- I²C / PMBus™ digital interface



CAR2512FP



- 2,500 watts / 12Vout
- Efficiency of 90% @ 20% load (92.1% peak)
- Power density of 25W/in³
- Universal AC input range with active PFC
- 15.38 x 4.00 x 1.65" / 378.0 x 102.0 x 41.9mm
- I²C / PMBus™ digital interface



24V & 48V Front Ends

CAR1248FP



- 1,200 watts / 48Vout
- High efficiency operation - up to 91%
- Power density of 19W/in³
- Universal AC input range with active PFC
- 11.20 x 3.44 x 1.65" / 284.5 x 87.4 x 41.9mm
- I²C / PMBus™ digital interface
- Mates with ACE125 Shelf



CAR2024FP



- 2,000 watts / 24Vout
- High efficiency operation - up to 90.5%
- Power density of 21W/in³
- Universal AC input range with active PFC
- 14.25 x 4.00 x 1.65" / 316.2 x 101.6 x 41.9mm
- I²C / PMBus™ digital interface
- Mates with ACE204 Shelf



CAR2548FP



- 2,500 watts / 48Vout
- High efficiency operation - up to 91%
- Power density of 27W/in³
- Universal AC input range with active PFC
- 14.25 x 4.00 x 1.65" / 362.0 x 102.0 x 40.9mm
- I²C / PMBus™ digital interface
- Mates with ACE254 Shelf



CAR2548DC



- 2,500 watts / 48Vout
- High efficiency operation - up to 91%
- Power density of 27W/in³
- 36-75VDC input range
- 14.25 x 4.00 x 1.61" / 362.0 x 102.0 x 40.9mm
- I²C / PMBus™ digital interface
- Mates with ACE254 Shelf

48Vin



CAR3000/CAR4000



- 3,000 or 4,000 watts / 24 or 48Vout
- High efficiency operation - up to 90%
- Single or three-phase 220 VAC with PFC
- 12.12 or 14.12 x 5.00 x 5.00" / 307.8 or 358.6 x 127 x 127mm
- I²C digital interface / analog status & control
- Mates with ACE3000 / ACE4000 Shelf



NEW!

EP1000-U

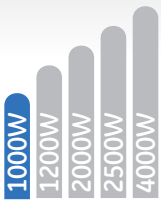

- 1000 watts / 54Vout
- High efficiency operation - up to 90%
- Power density of 16.9W/in³
- Universal AC input range with active PFC
- 8.19 x 4.58 x 1.58" / 208.0 x 116.5 x 40.2mm
- RS485 communication interface
- Mates with SPS Shelf Family



CAR1248TN

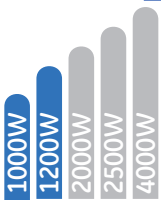

- 1,200 watts / 48Vout
- High efficiency operation - up to 91%
- Power density of 19W/in³
- Universal AC input range with active PFC
- 11.20 x 3.44 x 1.65" / 284.5 x 87.4 x 41.9mm
- I²C / PMBus™ digital interface
- Mates with ACE125 Shelf



CP2000DC54

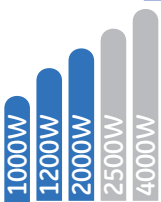

- 2000 watts / 54Vout
- 40-60VDC input range
- High efficiency operation - up to 90%
- Power density of 22W/in³
- 13.85 x 4.00 x 1.63" / 352.0 x 101.6 x 41.4mm
- I²C digital interface
- Mates with CPL PEM shelf

48Vin POE READY

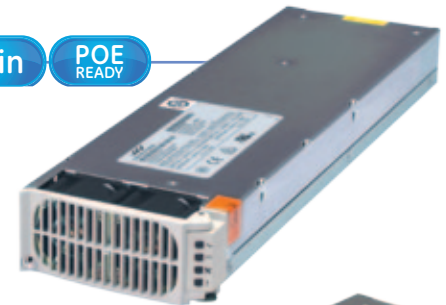

NEW!

CP2000TE/2725TE



- 2000 or 2725 watts / 54Vout
- High efficiency operation - approaching 97%
- Power density of 30W/in³
- 13.85 x 4.00 x 1.63" / 356.0 x 101.6 x 41.4mm
- I²C and RS485 communication interface
- Mates with CPL Shelf Family

80 PLUS PLATINUM

POE READY



CAR2548TN



- 2,500 watts / -48Vout
- High efficiency operation - up to 91%
- Power density of 27W/in³
- 14.25 x 4.00 x 1.61" / 362.0 x 102.0 x 40.9mm
- I²C / PMBus™ digital interface
- Mates with ACE254 Shelf

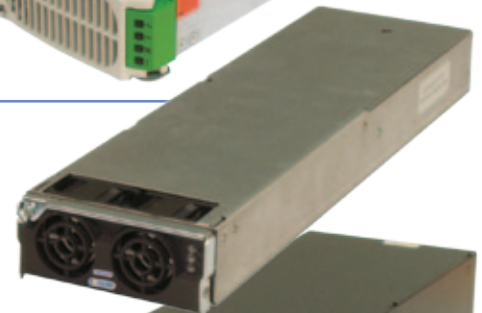

CAR3000T/CAR4000T



- 3,000 or 4,000 watts / 24 or 48Vout
- High efficiency operation - up to 90%
- Single or three-phase 220 VAC with PFC
- 12.12 or 14.12 x 5.00 x 5.00" / 307.8 or 358.6 x 127.0 x 127.0mm
- I²C digital interface / analog status & control
- Mates with ACE3000 / ACE4000 Shelf



Power Shelves

ACE125

- 48V front end or rectifier shelf
- Mates with CAR1248 modules
- 5 bay power shelf
- 5 x 1,200W power modules
- 4,800W N+1 redundant
- 6,000W total power
- 1U High 19" / 483.0mm rack mount
- 14.98" / 380.5mm depth
- Class B emissions with fully populated shelf



ACE254

- 48V front end or rectifier shelf
- Mates with CAR2548 or CAR2024 modules
- 4 Bay power shelf
- 4 x 2,500W power modules
- 10,000W total power
- 7,500W N+1 redundant
- 1U High 19" / 483.0mm rack mount
- 18.07 / 459.0mm" depth
- Class B emissions with fully populated shelf



ACE3000

- 24V / 48V front end or rectifier shelf
- Mates with CAR3000 & CAR3000T modules
- 3 bay power shelf
- 3 x 3000W power modules
- 9,000W total power
- 6,000W N+1 redundant
- 3U High 19" / 483.0mm rack mount
- 16" / 306mm depth



ACE4000

- 24V / 48V front end or rectifier shelf
- Mates with CAR4000 & CAR4000T modules
- 3 bay power shelf
- 3 x 4,000W power modules
- 12,000W total power
- 8,000W N+1 redundant
- 3U High 19" / 483.0mm rack mount
- 18" / 457.2mm depth



Dozens of standard configurations are available including options for batteries, enclosures, sensors and cables. Please consult GE Energy Technical Support to discuss your specific installation requirements.

SPS Platform

- 48V rectifier shelf
- Mates with EP1000-U rectifier modules
- 1U High 19" / 483mm rack mount
- Maximum 10.37" / 264.0mm depth
- Adjustable mounting ears (flush or mid-mount)
- Rear / front panel DC distribution options
- Breaker and fuse panel options
- Optional pulsar edge controller



Pulsar Edge Controller

- Available for both CPL & SPS platforms
- Compact design installs in shelf
- Preserves rectifier slots
- Advanced rectifier and battery management
- Web based GUI control
- Extensive alarm capability & data logging
- RJ45 craft and ethernet ports
- Up to 5 Form C Relay Contacts



CPL Platform

- 48V rectifier shelf
- Mates with CP2000 / CP2725TE rectifier modules
- 1U High 19" / 483mm rack mount
- Maximum 17.21" / 487.0mm depth
- Adjustable mounting ears (flush or mid-mount)
- Rear / front panel DC distribution options
- Breaker and fuse panel options
- Optional Pulsar Edge Controller



CPL Shelves are available without the integral Pulsar Edge Controller. These shelves may be purchased for stand-alone operation or paired with other battery controller options:

- **NE843G Pulsar Plus Controller**
Separate 1U Height Controller
- **CP843A Pulsar Controller**
Takes up one Slot of Power Shelf

Both controllers provide advanced battery management with: Front-Panel GUI Controls; Web-Based GUI Controls; Extensive Alarm Capability and Data Logging; RJ45 Craft and Ethernet Ports; and 10 Form C Relay Contacts.

Remote Power

CPS3200U Upstream Converter:

The CPS3200U Upstream Converter is a 2U High Rack Mounted Power System that allows remote 48VDC devices to be powered using existing twisted-pair T1/E1 copper wire facilities. This allows power to triple-play electronics at the Serving Area Interface (SAI) to be remotely fed from a centrally located power office. For power transmission across the copper pairs, 48V power is converted to +190V and then down-converted to 48VDC at the remote end. The CPS3200U shelf accommodates up to 32 channels of 100VA power-limited circuits (multi-shelf configurations are available). The two-circuits per module layout makes provisioning simple (matches the CPS2500D Downstream Converter). Craft safety is enhanced by providing current limit and ground fault safety circuitry. Both front access and rear access versions are available, configured for convenient installation and service.



CPS2500D Downstream Converter:

The CPS2500D Downstream Converter is a 1U High 19" Rack Mount Power System that converts $\pm 190V$ into bulk 48VDC at the downstream end Serving Area Interface (Cross-Connect cabinet). The shelf can house up to ten power modules for a total of 1300W capability. Each power module has two DC-DC circuits providing a total of 20 input channels. The LED interface on the front of each power module helps quickly diagnose and resolve network issues. Each shelf is equipped with a Power Major and a Power Minor form-C alarm relay.

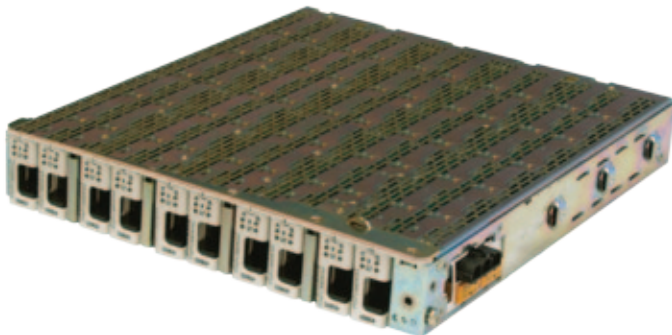

Applications:

- Fiber-To-The-Node (FTTN) networks
- Fiber-To-The-Curb (FTTC) networks
- Remote power, express power, span power or line power deployments
- Powering telecom equipment over twisted pairs (RFT-V)
- Powering access electronics using the existing copper network

Features:

- Short circuit, overload, overvoltage and undervoltage shutdown circuits
- $-40^{\circ}C$ to $75^{\circ}C$ operating temperature
- $32 \pm 190VDC$ 100VA output circuits
- Inrush protected, hot swap modules
- Full front access for cabling with simple craft interface
- 5 mA ground fault shutdown for A2 safety level
- Front panel LED Indicators
- Vertical airflow

CPS3200U Specifications:

- Input range: $-40VDC$ to $-59VDC$
- $\pm 190VDC$ output voltage
- Output power of 190 VA per module
- Output conducted noise spectrum $< GR-1089$ limits (10kHz to 30MHz)
- Fused & polarity input protection
- Over/under voltage, overcurrent and ground fault shutdown
- Max input current at 40.0Vin 5.8A per card (two converters per card)
- Output current ground fault limit: 5mA (each circuit)

CPS2500D Specifications:

- Nominal input voltage: $\pm 190VDC$
- Output power (RFT-V): 65W per channel, 1300W per shelf maximum
- Input voltage range: $\pm 95VDC$ (190VDC) to $\pm 190VDC$ (380VDC)
- Number of inputs: 20
- Typical input current limit: 0.226A
- Input via RJ-21 male connector
- Output voltage setpoint: $-54.5VDC$
- Input protection: inrush, internal fuse

The Lineage Power Compact PCI Power Supplies are highly reliable power supplies designed specifically for Compact PCI® systems, which are used in communications, industrial, military, aerospace, and other applications. These power supplies offer high power-density in plug-in modules that meet the requirements of the PICMG® 2.11 power interface specification for Compact PCI® systems.

Our products feature:

- PICMG 2.11 3U x 8HP compliant products
- Universal AC input models (90-264 VAC with Active PFC)
- 48VDC input models (36 - 72VDC input range)
- UL, CUL & TUV safety certifications
- Active current share for parallel operation
- Hot-swap / N+1 redundant operation
- No minimum load eliminates the need for preload on system backplane
- Active current share for increased reliability & scalability
- Available in AC or DC input models for a single source of both input versions

AC INPUT MODELS

Model	Power	Outputs	Package
CMP150	150 Watts	5V @ 20A	3U 6.68 x 5.07 x 1.59"
		3.3V @ 33A	
CMP200	200 Watts	12V @ 8A	3U 6.68 x 5.07 x 1.59"
		-12V @ 1.5A	
CMP400	400 Watts	5V @ 25A	6U 6.76 x 1.58 x 10.31"
		3.3V @ 35A	
		12V 2 8A	
		-12V @ 1.5A	
		5V @ 50A	
		3.3V @ 50A	
		12V @ 12A	
		-12V @ 4A	

48VDC INPUT MODELS (36-72 Vin Range)

Model	Power	Outputs	Package
DMP150	150 Watts	5V @ 20A	3U 6.68 x 5.067 x 1.588 in.
		3.3V @ 33A	
DMP200	200 Watts	12V @ 8A	3U 6.68 x 5.067 x 1.588 in.
		-12V @ 1.5A	
DMP400	400 Watts	5V @ 25A	6U 6.762 x 1.584 x 10.311 in.
		3.3V @ 35A	
		12V @ 8A	
		-12V @ 1.5A	
		5V @ 50A	
		3.3V @ 50A	
		12V @ 12A	
		-12V @ 4A	



Isolated DC-DC Converters

Low Power & 1/16 Bricks.....	15
1/8 Bricks	16
1/4 & 1/2 Bricks	17
Fully Regulated Bus Converters	18
Power Amplifiers	19
Filter & PIM Module	20

Product Matrix:

		MODEL	INPUT	ISOLATION	FOOTPRINT	OUTPUT	MAX POWER	0W	100W	200W	300W	400W
Isolated & Regulated DC-DC Converters	Page 15	SC / SW	24 / 48V	2250VDC	1 X 1	3.3 - 15V	3.3 - 15V					
		HC / HW	24 / 48V	1500VDC	1 X 2	1.2 - 5V	12A / 33W					
		KNW	36~75V	2250VDC	1/16 BRICKS	3.3 - 5V	20A / 66W					
	Page 16	Stingray ESTW	36~75V	2250VDC		3.3 - 12V	25A / 82W					
		EHW	36~75V	2250VDC		1/8 BRICKS	5 - 12V	15A / 80W				
		EVW	36~75V	2250VDC	5 - 12V		20A / 120W					
		EQD	18~60V	1500VDC		3 - 5.5V	20A / 75W					
	Page 17	QRW	36~75V	1500VDC	1/4 BRICKS	1.2 - 12V	40A / 120W					
	Page 17	QPW	36~75V	1500VDC	1/4 BRICKS	3.3V	60A / 165W					
	Page 17	JRW	36~75V	1500VDC	1/2 BRICKS	1.2 - 12V	70A / 204W					
Fully Regulated Bus Converters	Wide Range Page 18	Barracuda QBDW (Digital)	36~75V	2250VDC	1/4 BRICKS	8.1 - 13.2V	33A / 400W					
		Barracuda (Standard 5-Pin)	36~75V	2250VDC		8.1 - 13.2V	33A / 400W					

350~700 Watt RF Amplifier Converters listed on Page 19
DC Filters and ATCA PIM Modules listed on Page 20



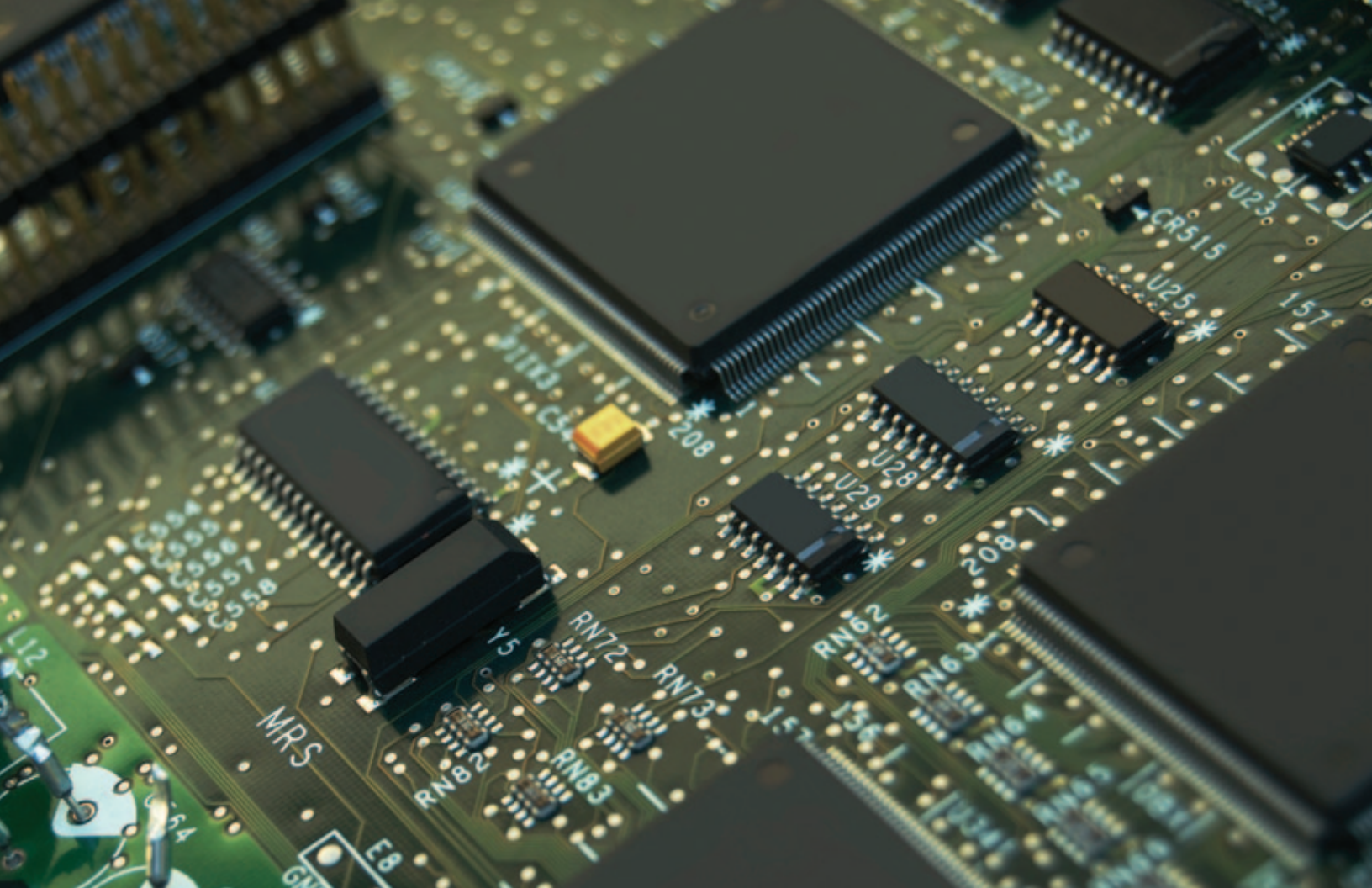

Featured Product:

Barracuda Series

- 36-75VDC input model
- 12VDC output model
- High efficiency operation up to 96%
- Remote sense and output voltage trim
- DOSA-standard quarter brick
- Digital interface with PMBus™
- Negative remote On/Off logic



SC / SW Series

15W / 3.5A Max Power

- 24 & 48VDC input models
- 3.3-15VDC output models
- 1.10 x 0.96 x 0.34" / 27.94 x 24.38 x 8.5mm
- Surface-mount or through-hole
- High efficiency operation up to 88%
- Remote on/off control



Part Number	Input Voltage	Vout	Iout	Eff
SC003A5F	24V (18-36V)	3.3V	3.5A	84%
SC003A0A	24V (18-36V)	5V	3A	85%
SC001A2B	24V (18-36V)	12V	1.2A	86%
SW003A5F	48V (36-75V)	3.3V	3.5A	86%
SW003A0A	48V (36-75V)	5V	3A	86%
SW001A2B	48V (36-75V)	12V	1.2A	88%
SW001A0C	48V (36-75V)	15V	1A	88%

HC / HW Series

33W / 12A Max Power

- 24 & 48VDC input models
- 1.2-5VDC output models
- 1.86 x 1.16 x 0.34" / 47.2 x 29.5 x 8.5mm
- Surface-mount or through-hole
- High efficiency operation up to 91%
- Remote on/off control



Part Number	Input Voltage	Vout	Iout	Eff
HC005A0F	24V (18-36V)	3.3V	5A	86%
HC004A0A	24V (18-36V)	5V	4A	88%
HW006A0P	48V (36V-75V)	1.2V	6A	78%
HW006A0Y	48V (36V-75V)	1.8V	6A	82%
HW006A0G	48V (36V-75V)	2.5V	6A	86%
HW005A0F	48V (36V-75V)	3.3V	5A	87%
HW004A0A	48V (36V-75V)	5V	4A	89%
HC010A0F	24V (18V-36V)	3.3V	10A	90%
HC006A6A	24V (18V-36V)	5V	6.6A	91%
HW012A0Y	48V (36V-75V)	1.8V	12A	85%
HW010A0G	48V (36V-75V)	2.5V	10A	89%
HW010A0F	48V (36V-75V)	3.3V	10A	90%
HW006A6A	48V (36V-75V)	5V	6.6A	91%

KNW Series

66W / 20A Max Power

- 48VDC input models
- 3.3-5VDC output models
- 1.30 x 0.90 x 0.40" / 33.0 x 22.9 x 10.2mm
- Surface-mount or through-hole
- High efficiency operation up to 91%
- Remote on/off control, sense and trim functions



Part Number	Input Voltage	Vout	Iout	Eff
KNW020A0F	48V (36V-75V)	3.3V	20A	91%
KNW013A0A	48V (36V-75V)	5V	13A	91%

2250VDC Isolation for PoE Applications

NEW!

ESTW Stingray Series

82W / 25A Max Power

- 48VDC input model
- 3.3VDC output model
- 2.28 x 0.90 x 0.34" / 57.9 x 22.8 x 8.52mm
- Surface-mount or through-hole
- High efficiency operation up to 91%
- On/off, remote sense & trim functions



Part Number	Input Voltage	Vout	Iout	Eff
ESTW015A0F	48V (36V-75V)	3.3V	15A	91%
ESTW025A0F	48V (36V-75V)	3.3V	25A	92%

EHW Series

80W / 15A Max Power

- 48VDC input models
- 5 or 12VDC output models
- 2.30 x 0.90 x 0.32 / 58.4 x 22.8 x 8.4mm
- Surface-mount or through-hole
- High efficiency operation up to 93%
- On/off, remote sense & trim functions
- Optional baseplate



Part Number	Input Voltage	Vout	Iout	Eff
EHW015A0A	48V (36V-75V)	5V	15A	92%
EHW007A0B	48V (36V-75V)	12V	7A	93%

2250VDC Isolation for PoE Applications

EVW Series

120W / 20A Max Power

- 48VDC input models
- 5 or 12VDC output models
- 2.30 x 0.90 x 0.31 / 58.4 x 22.8 x 8.1mm
- Surface-mount or through-hole
- High efficiency operation up to 93%
- Enable, sense and trim functions
- Optional baseplate



Part Number	Input Voltage	Vout	Iout	Eff
EVW020A0A	48V (36V-75V)	5V	20A	92%
EVW020A0S6R0	48V (36V-75V)	6V	20A	92%
EVW010A0B	48V (36V-75V)	12V	10A	93%

*2250VDC Isolation for PoE Applications
More output voltages available upon request*

EQD Series

75W / 20A Max Power

- 18-60VDC input models
- Programmable 3.0-5.5VDC output
- 2.28 x 0.90 x 0.34" / 57.9 x 22.8 x 8.5mm
- Through Hole Package
- High efficiency operation up to 90%
- On/off, remote sense & trim functions



Part Number	Input Voltage	Vout	Iout	Eff
EQD075A	24/48V (18V-60V)	3.3V 5V	20A 15A	90%

Output is programmable from 3.0 - 5.5V

QRW Series 120W / 40A Max Power

- 48VDC input models
- 1.2-12VDC output models
- 1.45 x 2.28 x 0.38" / 36.8 x 57.9 x 9.5mm
- Surface-mount or through-hole
- Optional baseplate
- High efficiency operation up to 92%
- Enable, sense and trim functions



Part Number	Input Voltage	Vout	Iout	Eff
QRW025A0P	48V (36V-75V)	1.2V	25A	85%
QRW025A0M	48V (36V-75V)	1.5V	25A	87%
QRW025A0G	48V (36V-75V)	2.5V	25A	90%
QRW025A0F	48V (36V-75V)	3.3V	25A	91%
QRW040A0M	48V (36V-75V)	1.5V	40A	86%
QRW040A0Y	48V (36V-75V)	1.8V	40A	87%
QRW035A0G	48V (36V-75V)	2.5V	35A	90%
QRW035A0F	48V (36V-75V)	3.3V	35A	91%
QRW025A0A	48V (36V-75V)	5V	25A	92%
QRW010A0B	48V (36V-75V)	12V	10A	91%

QPW Series 165W / 60A Max Power

- 48VDC input models
- 1.2-3.3VDC output models
- 2.28 x 1.45 x 0.42" / 57.9 x 36.8 x 10.6mm
- Through-hole package
- Optional Baseplate
- High efficiency operation up to 93%
- Enable, sense and trim functions



Part Number	Input Voltage	Vout	Iout	Eff
QPW025A0F	48V (36V-75V)	3.3V	25A	93%
QPW060A0P	48V (36V-75V)	1.2V	60A	85%
QPW060A0M	48V (36V-75V)	1.5V	60A	87%
QPW060A0Y	48V (36V-75V)	1.8V	60A	89%
QPW060A0G	48V (36V-75V)	2.5V	60A	91%
QPW050A0F	48V (36V-75V)	3.3V	50A	93%

JRW Series 204W / 70A Max Power

- 48VDC input models
- 1.5-12VDC output models
- 2.40 x 2.30 x 0.375" / 61.0 x 58.4 x 9.5mm
- Through-hole package
- Optional Baseplate
- High efficiency operation up to 92%
- Enable, sense and trim functions

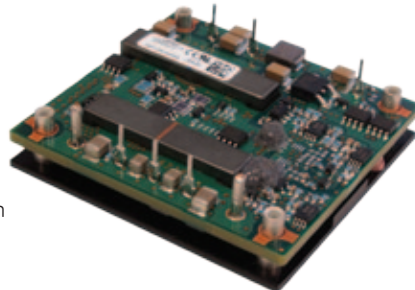

Part Number	Input Voltage	Vout	Iout	Eff
JRW070A0M	48V (36-75V)	1.5V	70A	86%
JRW065A0Y	48V (36-75V)	1.8V	65A	87%
JRW065A0G	48V (36-75V)	2.5V	65A	90%
JRW060A0F	48V (36-75V)	3.3V	60A	91%
JRW040A0A	48V (36-75V)	5V	40A	92%
JRW017A0B	48V (36-75V)	12V	17A	92%

The new Lineage Power® Barracuda™ family of digitally controlled, fully-regulated bus converters are DOSA compliant, drop-in replacements for unregulated and semi-regulated bus converters challenged by recent industry-wide intellectual property issues.

Fully Regulated Bus Converters:



Barracuda Series

400W / 33A Max Power

- 36-75VDC input model
- 12VDC output model
- High efficiency operation up to 96%
- Remote sense and output voltage trim
- DOSA-standard quarter brick
- Digital interface with PMBus™
- Negative remote On/Off logic
- Output overcurrent/ overvoltage protection
- Over temperature protection
- Wide operating temperature range (-40°C to °85C)
- 2.30 x 1.45 x 0.46"/58.4 x 36.8 x 11.7mm
- Optional baseplate



Part Number	Input Voltage	Vout	Iout	Eff
QBWD025A0B	48V (36V-75V)	12V	25A	96%
QBWD033A0B	48V (36V-75V)	12V	33A	96%
QBVW033A0B	48V (36V-75V)	12V	33A	96%

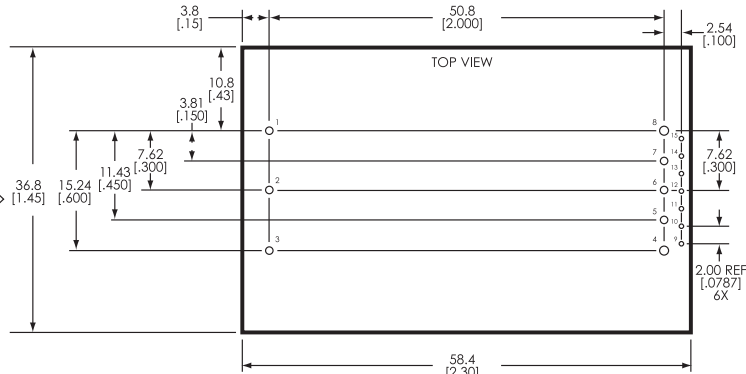
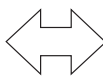
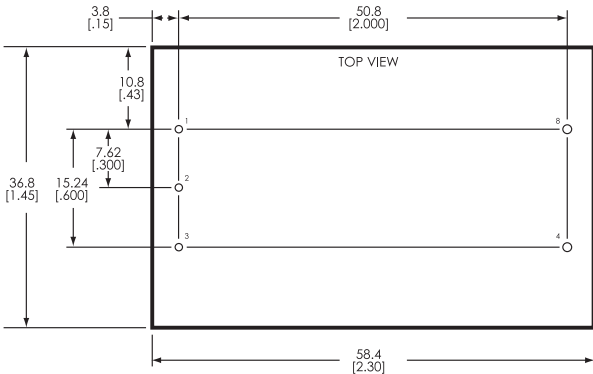

Pin #	Pin Name
1	VIN (+)
2	ON/OFF
3	VIN (-)
4	VOU (-)
8	VOU (+)

Pin #	Pin Name	Pin #	Pin Name	Pin #	Pin Name
1	VIN (+)	6	TRIM/C1	11	SIG_GND
2	ON/OFF	7	SENSE (+)	12	SMBALERT
3	VIN (-)	8	VOUT (+)	13	CLK
4	VOU (-)	9	C2	14	ADDR1
5	SENSE (-)	10	DATA	15	ADDR0

Barracuda QBVW Series

- Standard 5-pin IBA pin-out
- Drop in replacement for semi-regulated and unregulated bus converters
- Full digital control

Barracuda QBWD Series

- Conforms to new DOSA standard for "Second Generation Single Output Pin DC-DC Converters with Digital Connections"
- Fully backwards compatible with existing quarter and eighth bricks
- Digital interface with PMBus™
- Two user configurable pins

Power Amplifiers

1/2 Brick:

A new generation of power modules designed for maximum cost effectiveness and power density, the industry standard half-brick series DC-DC converter is an ideal choice for high voltage and power amplifier applications.



JRCW Orca Series

- 450 watts maximum power
- 36-75VDC input/32VDC output model
- Output voltage adjustment trim, 16.0VDC to 35.2VDC
- High efficiency operation up to 94%
- Integral metal baseplate with optional threaded inserts
- Optional Tunable Loop™ for optimized output capacitance
- Operates at full power to case temperatures of 85°C
- 2.27 x 2.39 x 0.5" / 57.7 x 60.7 x 12.7mm

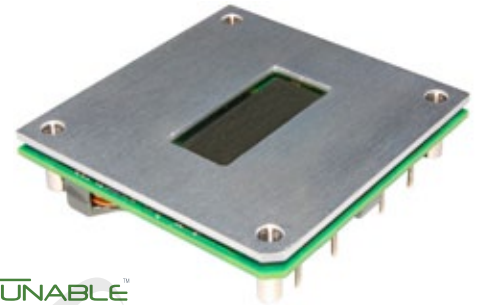

JNC/JNW350 Module

- 350 watts maximum power
- 18-36 / 36-75VDC input/28VDC output model
- Output voltage adjustment trim, 16.8VDC to 32.0VDC
- High efficiency operation up to 92%
- Integral metal baseplate with optional threaded inserts
- Optional Tunable Loop™ for minimized output capacitance
- Operates at full power to case temperatures of 85°C
- 2.27 x 2.39 x 0.5" / 57.7 x 60.7 x 12.7mm

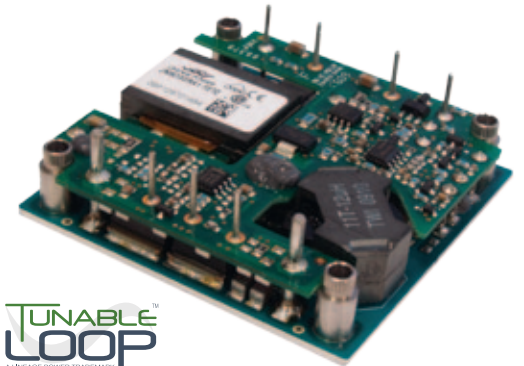

Model	Vin Range	Vout (nom)	Iout	Efficiency
JNC350R	18V - 36V	28V	12.5A	92%
JNW350R	36V - 75V	28V	12.5A	92%

Full Brick:

A new generation of open frame isolated DC-DC converter in an industry standard full-brick package suitable for wireless base stations and other similar telecom equipment including RF power amplifier applications, wireless networks, and switching networks.

FNW700 Module

- 700 watts maximum power
- 36-75VDC input / 28VDC output model
- Output voltage adjustment trim, 16.8VDC to 32.0VDC
- High efficiency operation up to 90%
- Integral metal baseplate with optional threaded inserts
- Operates at full power to case temperatures of 90°C at 700 Watts
- 4.6 x 2.4 x 0.5" / 116.8 x 61.0 x 12.7mm

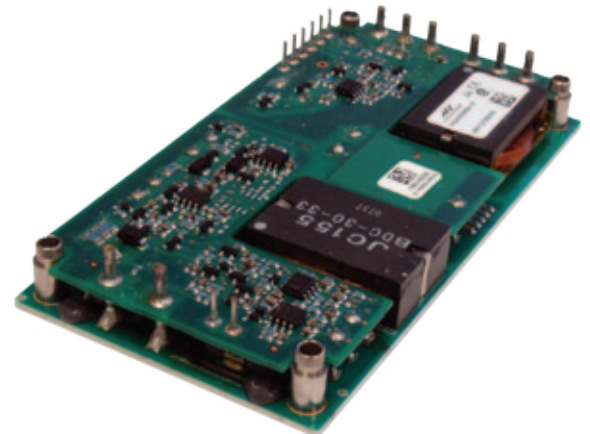

Filter Modules

The internal operation of DC-DC converters utilize pulsed voltages and currents which can generate broad-spectrum noise that results in electromagnetic emissions. To ease the task of meeting International Standards that limit emissions, GE Energy offers a range of input filter modules with current ratings of 5A, 7A, 10A, and 20A. One properly sized filter module can be used with one or multiple DC-DC converter modules. Our filter modules reduce the levels of conducted common-mode and differential-mode noise, providing high insertion loss throughout the frequency range regulated by such bodies as the International Special Committee on Radio Interference (CISPR) and the U.S. Federal Communications Commission (FCC).

All our filter modules are rated for differential input voltages up to 75VDC and common-mode input voltages up to 1500VDC. For further details on managing EMC, refer to individual DC-DC module and filter datasheets.

Model	Rated Voltage	Rated Current	Common-Mode Insertion Loss	Differential-Mode Insertion Loss	Resistance per leg (mohms)	Dimensions
FLTR75V05	0-75VDC	5A max	28dB	25dB	20	1.00 x 1.00 x 0.40"
FLT007A0	0-75VDC	7A max	60dB	66dB	25	1.00 x 1.00 x 0.46"
FLTR100V10	0-75VDC	10A max	36dB	44dB	14	2.00 x 1.10 x 0.46"
FLTR100V20	0-75VDC	20A max	32dB	36dB	6.6	2.00 x 1.60 x 0.50"



FLTR75V05



FLT007A0



FLTR100V10



FLTR100V20

Power Input Module

The PIM300 used in conjunction with Lineage Power Isolated DC-DC Converter and Non-Isolated Point-of-Load Modules provides a complete, low-cost power architecture that complies with Advanced TCA™ board power requirements. The PIM300 provides high-reliability with innovative features and compact design as a low cost, simple power architecture solution for complex power requirements.

Features

- Delivers up to 300W of rated power
- High efficiency: 97% typical
- Inrush current limit protection
- Integrated filter for CISPR class B EMI limits
- 8W of isolated aux power for IPMI (3.3V or 5V)
- ORing FETs for A&B feeds
- A&B feeds loss alarm
- Hot swap control
- 72V supply for hold-up/bulk capacitor
- Through-hole package
- Measures only 2.78 x 1.45 x 0.50"

Specifications

- Input voltage range: 38VDC to 75VDC
- Management power (5V/3.3V): 8W max
- Operating temperature range: -5°C to 70°C
- Basic insulation

Protection features

- Output current and over temperature protections
- Input over voltage protection
- Input under voltage lockout
- Short circuit protection



Non-Isolated Point-of-Load Converters

Tunable Loop™ Technology	23
DLynx™ POL Modules	23
ProLynx™ POL Modules	24
TLynx® POL Modules	24
Naos Raptor™ POL Modules	24
Digital Converters	25

Product Matrix:

		VDC INPUT RANGE	VDC INPUT RANGE	OUTPUT CURRENT	FOOTPRINT	0A	10A	20A	30A	40A	50A	60A
Surface Mount Modules Page 24	PicoDLynx	3.0-14.0V	0.60-5.5V	12A	0.48 X 0.48 X 0.34"							
	MicroDLynx	3.0-14.0V	0.60-5.5V	20A	0.80 X 0.45 X 0.33"							
	ProLynx	9.0-36.0V	3.0-18.0V	2.5-5A	0.80 X 0.45 X 0.34"							
		3.0-14.0V	0.60-5.5V	2A	0.48 X 0.48 X 0.25"							
	PicoTLynx	4.5-14.0V	0.60-5.5V	3A	0.48 X 0.48 X 0.25"							
		8.0-16.0V	0.59-8.0V	4A	0.48 X 0.48 X 0.29"							
		4.5-14.0V	0.59-5.5V	6A	0.48 X 0.48 X 0.29"							
		2.4-5.5V	0.60-3.6V	3A	0.48 X 0.48 X 0.25"							
		2.4-5.5V	0.59-3.6V	6A	0.48 X 0.48 X 0.29"							
	MicroTLynx	2.4-5.5V	0.60-3.6V	12A	0.80 X 0.45 X 0.33"							
		4.5-14.0V	0.69-5.5V	12A	0.80 X 0.45 X 0.33"							
	TLynx	2.4-5.5V	0.60-3.6V	20A	1.30 X 0.53 X 0.33"							
		4.5-14.0V	0.69-5.5V	20A	1.30 X 0.53 X 0.33"							
	MegaTLynx	6.0-14.0V	0.80-3.63V	30A	1.30 X 0.53 X 0.36"							
	GigaTLynx	4.5-14.0V	0.60-2.0V	50A	1.30 X 0.90 X 0.39"							
Single In-Line Package (SIPs) Page 24	Naos Raptor	4.5-14.0V	0.59-6.0V	3A	0.41 X 0.65 X 0.31"							
		4.5-14.0V	0.59-6.0V	6A	0.41 X 0.65 X 0.31"							
		4.5-14.0V	0.59-6.0V	10A	0.41 X 0.65 X 0.27"							
		4.5-14.0V	0.59-6.0V	20A	1.45 X 0.61 X 0.36"							
		5.0-13.8V	0.60-5.0V	40A	1.45 X 1.10 X 0.42"							
		5.0-14.0V	0.60-2.0V	50A	1.45 X 1.10 X 0.79"							
		5.0-13.8V	0.60-5.0V	60A	2.58 X 1.25 X 0.46"							

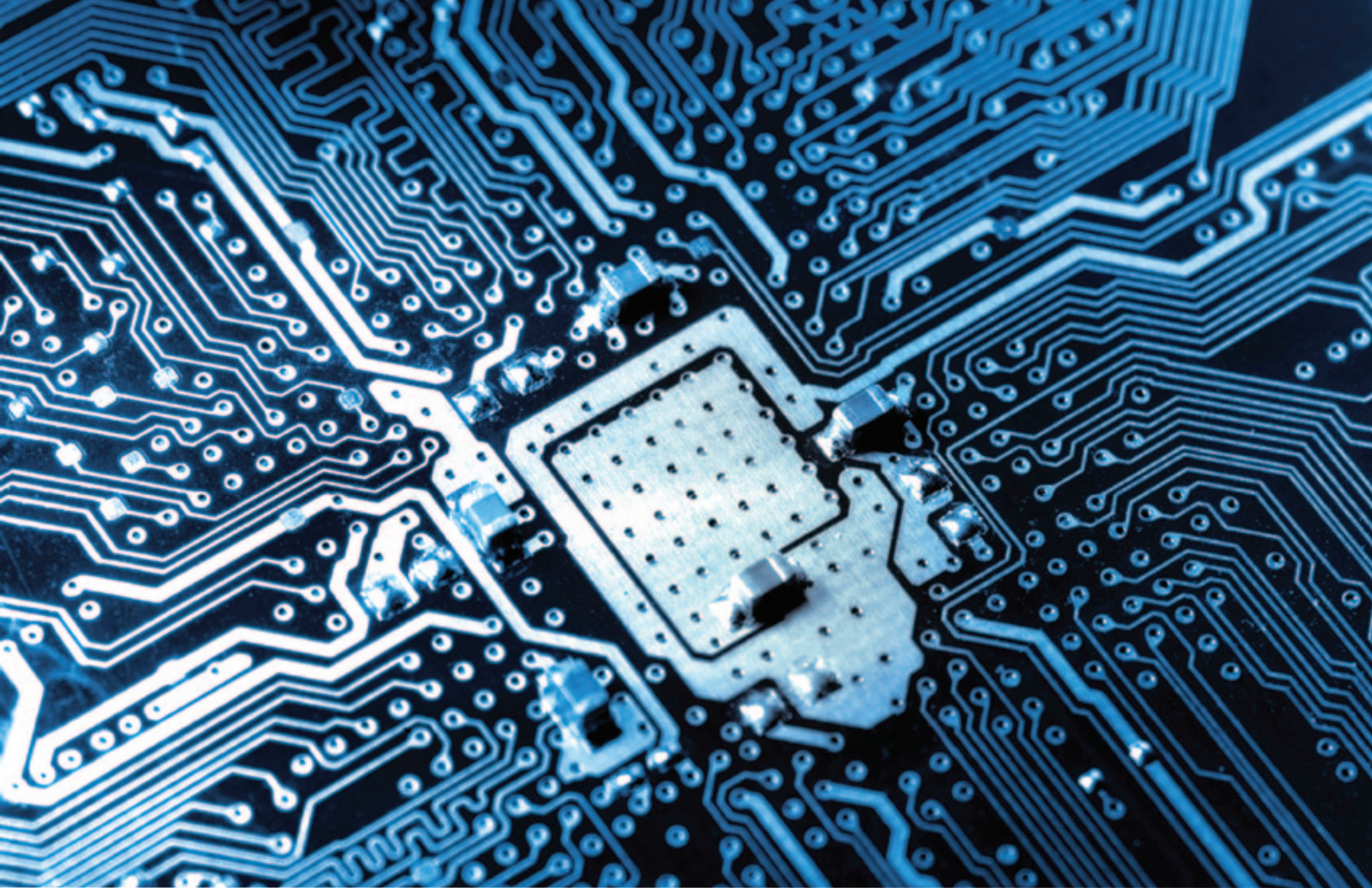

NEW!

Featured Family:

DLynx™ Series

- 12 or 20A output current
- 3-14VDC input models
- 0.60-5.5VDC output models
- Dual offering - both digital & analog versions
- Standards-based DOSA™ footprint
- Tunable Loop™
- Digital Communication (PMBus™)
- Total Efficiency™ architecture
- Superior thermal performance
- EZ-SEQUENCE™
- Cost efficient open frame design

www.DLynx.info



**TUNABLE
LOOP**
A LINEAGE POWER TRADEMARK

DOSA
Distributed-power
Open Standards Alliance

Next-Generation Non Isolated / POL

www.tunableloop.com

Tunable Loop™ Technology

Improved footprints, transient response, and costs



The power of Tunable Loop™ is a simple implementation of a resistor and capacitor in series across the Point of Load (POL) Trim and Output pins to optimize POL modules for multiple applications of varying demands. These very small passive devices never exceed a few kΩ resistance or a few hundred nF capacitance.

The figure below illustrates the transient response of a 12A PicoTLynx™ module to a 50% load step with varying external capacitance. The maximum voltage deviation improves from 415mV (0μF) to 235mV (3x47μF) but the control loop bandwidth drops from 78 to 21kHz, increasing the duration of the voltage excursion. This is consistent with the reduction in control bandwidth and poorer phase margin caused by increased capacitance.

Without Tunable Loop: High deviation and reduced control bandwidth with increased output capacitance.

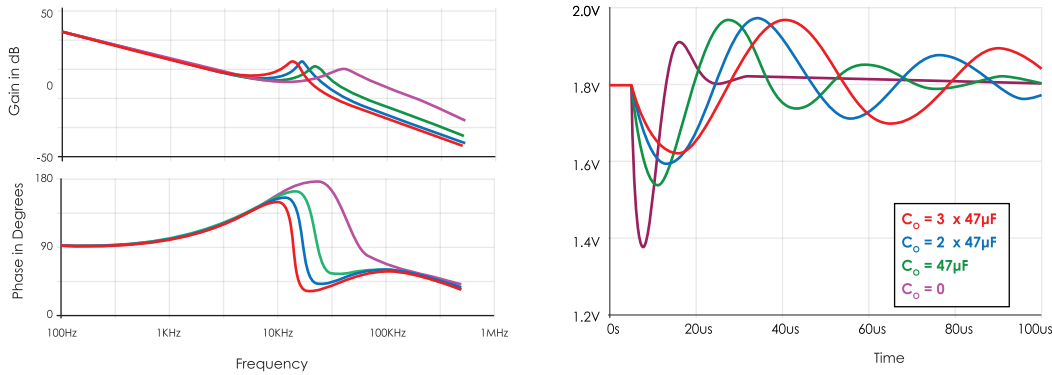

The goal of Tunable Loop™ is to regain the bandwidth lost with increased capacitance. If we fix the value of R_{Tune} to 150Ω and vary C_{Tune} from 0pF to 7500pF, we regain control bandwidth back to 82kHz and achieve a **4.8x reduction in voltage deviation**.

With Tunable Loop™: Substantially reduced deviation through improved control bandwidth and reduced output capacitance.

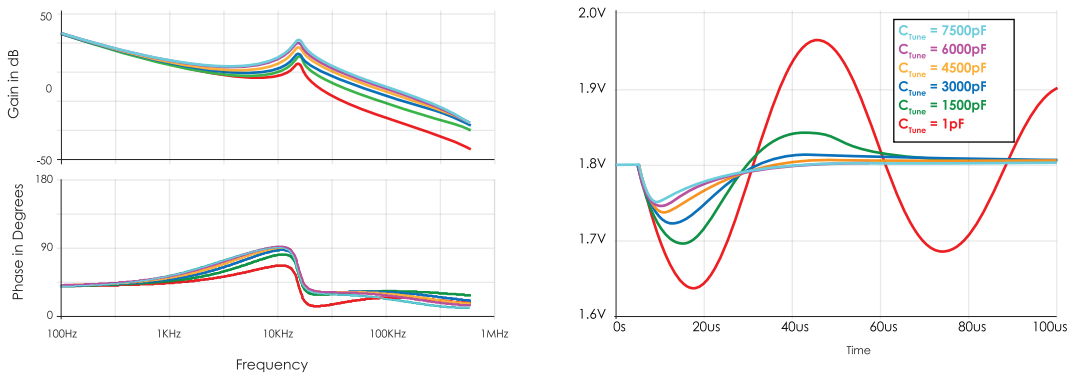

Tunable Loop™ achieves lower voltage deviation with significantly reduced capacitance. As an example, the 6A PicoTLynx™ module (5Vin / 1.2Vout @ 4A), with a step load of 3A and deviation <4% (48mV) would require 3 electrolytic caps versus 3 ceramic caps with Tunable Loop™. This results in a \$0.60 reduction in external capacitor cost and a footprint reduction of 111mm² achieving **>3X the effective current density**.

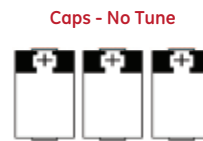
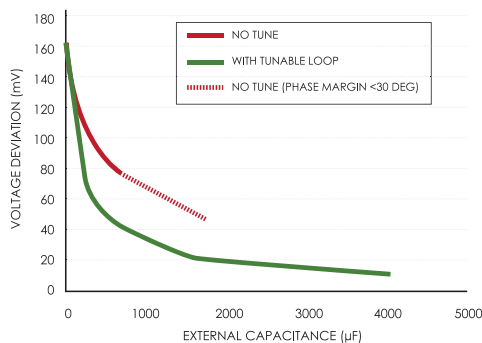

\$1.20 / 157mm²

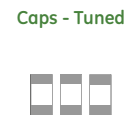

\$0.60 / 45.8mm²

50% Cost Reduction
61% Footprint Reduction

Tunable Loop™ POL Converter Modules

www.tunableloop.com

Improved footprints, transient response, and costs

DLynx™ - Surface Mount Models

Digital & Analog 4th Generation

Models	Model #	Digital/Analog	Input Voltage	Output Voltage	Output Current	Peak Efficiency	Dimensions
PicoDLynx	PDT012 NEW!	Digital	3.0-14.0V	0.60-5.50V	12A	96%	0.48 x 0.48 x 0.34"
	PVX012 NEW!	Analog	3.0-14.0V	0.60-5.50V	12A	96%	0.48 x 0.48 x 0.34"
MicroDLynx	UDT020 NEW!	Digital	3.0-14.0V	0.60-5.50V	20A	96%	0.80 x 0.45 x 0.33"
	UVT020 NEW!	Analog	3.0-14.0V	0.60-5.50V	20A	96%	0.80 x 0.45 x 0.33"



PicoDLynx™



MicroDLynx™



ProLynx™

ProLynx™ - Surface Mount Models

Models	Model #	Input Voltage	Output Voltage	Output Current	Peak Efficiency	Dimensions
ProLynx	APXW003 NEW!	9.0-36.0V	3.00-18.00V	3A	97%	0.80 x 0.45 x 0.33"
	APXW005 NEW!	9.0-36.0V	3.00-18.00V	5A	96%	0.80 x 0.45 x 0.33"

TLynx® - Surface Mount Models

Models	Model #	Input Voltage	Output Voltage	Output Current	Peak Efficiency	Dimensions
PicoTLynx	APXS002 NEW!	3.0-14.0V	0.60-5.50V	2A	96%	0.48 x 0.48 x 0.25"
	APTS003	4.5-14.0V	0.60-5.50V	3A	95%	0.48 x 0.48 x 0.25"
	APXK004	8.0-16.0V	0.59-8.00V	4A	96%	0.48 x 0.48 x 0.29"
	APTS006	4.5-14.0V	0.59-5.50V	6A	96%	0.48 x 0.48 x 0.29"
	APTH003	2.4-5.5V	0.60-3.63V	3A	95%	0.48 x 0.48 x 0.25"
	APTH006	2.4-5.5V	0.60-3.63V	6A	95%	0.48 x 0.48 x 0.29"
MicroTLynx	APTH012	2.4-5.5V	0.60-3.63V	12A	97%	0.80 x 0.45 x 0.33"
	APTS012	4.5-14.0V	0.69-5.50V	12A	97%	0.80 x 0.45 x 0.33"
TLynx	APTH020	2.4-5.5V	0.60-3.63V	20A	95%	1.30 x 0.53 x 0.33"
	APTS020	4.5-14.0V	0.69-5.50V	20A	97%	1.30 x 0.53 x 0.33"
MegaTLynx	APTS030	6.0-14.0V	0.80-3.63V	30A	96%	1.30 x 0.53 x 0.39"
GigaTLynx	APTS050 NEW!	4.5-14.0V	0.60-2.00V	50A	95%	1.30 x 0.90 x 0.39"

TLynx modules are available in ruggedized / MIL STD 810F compliant versions



PicoTLynx™
(2 Amps)



PicoTLynx™
(3-12 Amps)



MicroTLynx™



TLynx®



MegaTLynx™



GigaTLynx™

Naos Raptor™ - Single In Line Package (SIP)

Models	Model #	Input Voltage	Output Voltage	Output Current	Peak Efficiency	Dimensions
Naos Raptor	NSR003	4.5-14.0V	0.59-6.0V	3A	97%	0.41 x 0.65 x 0.31"
	NSR006	4.5-14.0V	0.59-6.0V	6A	97%	0.41 x 0.65 x 0.31"
	NSR010	4.5-14.0V	0.59-6.0V	10A	95%	0.41 x 0.65 x 0.27"
	NQR010	4.5-14.0V	0.59-6.0V	10A	97%	0.41 x 0.65 x 0.27"
	NSR020	4.5-14.0V	0.59-6.0V	20A	97%	1.45 x 0.61 x 0.36"
	NSR040	5.0-13.8V	0.60-5.0V	40A	95%	1.45 x 1.10 x 0.42"
	NSR050	5.0-14.0V	0.60-2.0V	50A	93%	1.45 x 1.10 x 0.79"
	NSR060	5.0-13.8V	0.60-5.0V	60A	95%	2.58 x 1.25 x 0.46"



3 / 6 / 10 Amp Models



20 Amp Models



40 / 50 Amp Models



60 Amp Models

Digital Converters

The new digitally controlled Lineage Power® DLYnx™ family of non-isolated Point of Load (POL) DC-DC board-mounted power modules and Lineage Power® Barracuda™ family of fully-regulated bus converters offer an industry-standard DOSA™ footprint and PMBus™ interface.

The DLYnx series offers spacesaving Tunable Loop™ technology at the highest current density in the industry. All DLYnx modules offer backwards analog compatibility, allowing power designers to engineer once in the exact same circuit board real estate and choose later whether to deploy digital or analog power components in volume production. As part of the Lineage Power Total Efficiency™ architecture, the new DLYnx modules deliver efficiency of 96 percent as well as the addition of new features such as differential remote sense and synchronization. These full featured solutions also offer remote On/Off, sequencing, over current and over temperature protection.

The cost-effective, high-efficiency Barracuda series delivers digital power communication and control in a standards-based quarter-brick DOSA footprint. Power design engineers can deploy the new Barracuda modules in existing power designs as DOSA-compliant, drop-in upgrades for unregulated and semi-regulated bus converters challenged by recent industry-wide intellectual property issues. As part of the Lineage Power Total Efficiency™ architecture, the new Barracuda modules deliver efficiency of 96 percent.

The Barracuda family is designed to provide a 9.6-12 Vdc intermediate bus voltage after which multiple, low voltage rails are generated using additional Point of Load (POL) converters such as DLYnx™. This architecture is designed to power silicon devices such as processors and memory devices on circuit boards using POL converters. Barracuda converters can also be utilized for other applications requiring a fully-regulated output voltage in distributed power architectures deployed in networking, Power over Ethernet (PoE), computing and data storage devices.

New synchronization features, active load sharing and differential remote sense are combined with a digital PMBus interface that supports a wide range of commands to both control and monitor the Barracuda modules with a full range of protections and warnings, digital on/off, trim, margin, power good, rise time adjustment, and input under voltage lockout.

Lineage Power® DLYnx™ - Surface Mount Models

Models	Model #		Input Voltage	Output Voltage	Output Current	Peak Efficiency	Dimensions
PicoDLYnx	PDT012	NEW!	3.0-14.0V	0.60-5.50V	12A	96%	0.48 x 0.48 x 0.34"
MicroDLYnx	UDT020	NEW!	3.0-14.0V	0.60-5.50V	20A	96%	0.80 x 0.45 x 0.33"



PicoDLYnx™



MicroDLYnx™

www.DLYnx.info

Lineage Power® Barracuda™ - Fully-Regulated Bus Converters

Models	Model #		Input Voltage	Output Voltage	Output Current	Peak Efficiency	Dimensions
Barracuda	QBDW033	NEW!	36-75V	12V	33A	96%	2.30 x 1.45 x 0.46"



Lineage Power® Barracuda™

Digital DC-DC Efficiency Impact

Digital communication allows system architects to adjust critical system parameters to optimize overall efficiency and minimize power dissipation. The data collected may also be employed to improve reliability and total cost of ownership (TCO).

Classic Definition of Efficiency (Power Supply-centric)

$$n = \frac{P_{out}}{P_{in}} = \frac{P_{in} - P_{diss}}{P_{in}}$$

Definition of System Efficiency

$$n = \frac{TPC}{P_{in}}$$

Module efficiency alone is not the most significant variable. System efficiency is the real target for optimization. TPC may be replaced by performance benchmarks, MIPS, etc...

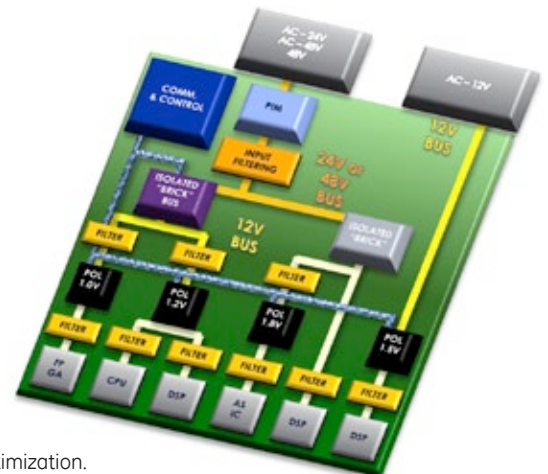

Industry Solutions for Vertical Markets:

GE Energy offers several isolated and non-isolated DC-DC converter modules, with an extended input voltage range. The wide input design for distributed power architectures and intermediate bus voltage applications targets the aerospace, automotive, industrial, medical, military and wireless communications industries, where discrete solutions have traditionally been used.

Benefits of Module Solutions:

- **Proven technology:** A fully qualified and tested power module solution from Lineage Power with over 30 years experience in designing board mounted power solutions.
- **Faster time-to-market:** Focus on your new product features rather than tackling the complexities of advanced power system design. Avoid additional board re-spins to optimize the power supply.
- **Design assistance:** Our customers receive total solution support from our field application engineers.
- **A compact solution:** Circuit board real estate is expensive – Lineage Power POLs occupy half the space of discrete solutions.
- **End-to-end solutions:** Comprehensive AC-DC power supplies and DC-DC board mounted power portfolio.
- **Total Efficiency™ technology:** Lower utility and cooling costs of your product by leveraging our advanced topologies and premium components that deliver efficiency approaching 97%.

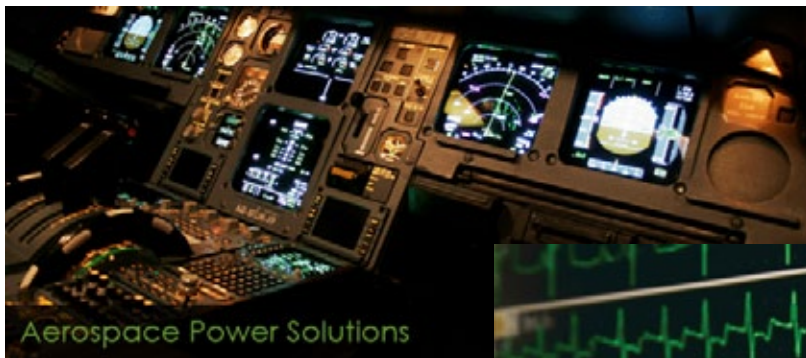

Custom Capabilities

Our Customer Focus

GE Energy's broad range of standard technologies are the ideal building blocks to solve your application's power requirements. Many of our customers want us to re-package our technologies to develop an optimal solution that maximizes performance while reducing their total cost of ownership.

Our ability to leverage our leading-edge technologies into specific customer applications is what makes us the ideal partner for your next application. We utilize our proven technologies to develop unique products that best fit your unique application, quickly and cost-effectively, substantially reducing risks and time-to-market.

Engineering Talent

GE Energy maintains independent Research & Development and Custom Product Development teams to ensure both continued development of next generation technology road maps as well as custom / modified designs. Our regional FAEs work closely with our customers to produce extremely clean engineering prototypes in a rapid fashion, substantially reducing time-to-market for our customers. In addition, we are self-certified to support all safety agencies, further reducing product development schedules.

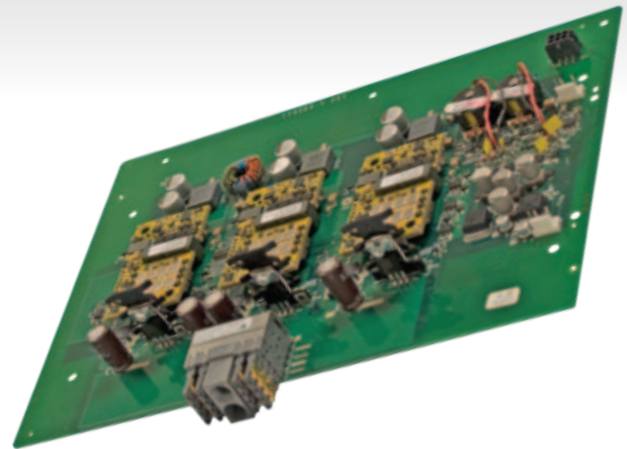

Advanced Tools & Capabilities

Lineage Power utilizes consistent development tools and processes in all its locations to enable product development in multiple locations. Design tools and capabilities include Mathcad Simulation, Flow Thermo Thermal Modeling, ProWorks 3D Modeling Software, Venable Closed-Loop Stability Analysis, Thermal Imaging Capability, and a foam layout process to quickly identify potential issues and assist in mechanical / thermal layout of the power solution.

Research & Design

Lineage Power maintains strategic alliances with key vendors to help define future technology direction and objectives. Our alliances allow us greater utilization of next generation technologies and topologies, achieving superior power densities and efficiencies.

Product Development

Once a solution is proven at the prototype level, our product development teams execute a full development process, finalizing the design and implementing improvements to the fabricated parts (such as PCBs, sheet metal, and magnetics), confirming the bill of materials, defining the quality assurance metrics, performing design verification tests, performing reliability tests (HALT / STRIFE), and testing for certification and EMI / safety qualification.

Post Sale / Technical Support

Lineage Power leverages its experienced FAE teams to resolve any issues relating to our power solutions. Our FAEs and design teams provide ongoing sales and technical support throughout the life of each application. Our closed loop engineering processes ensure continued process improvements and real world application trends into our future designs.

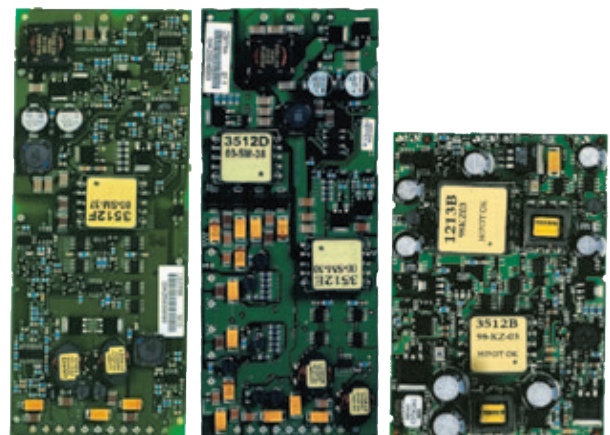

As a leading power provider, we offer low risk leading edge technology with consistent, high quality product produced around the world with localized support.

Manufacturing & Quality Control

Lineage Power's global operations and standardized processes enable us to build product at any of our global facilities utilizing consistent processes, equipment, training, and quality standards, ultimately ensuring our customers receive exceptional product regardless of the country of design or manufacture. In addition, our approach offers stability by ensuring product quality, faster, higher grade prototypes, and a reliable Disaster Recovery Program.

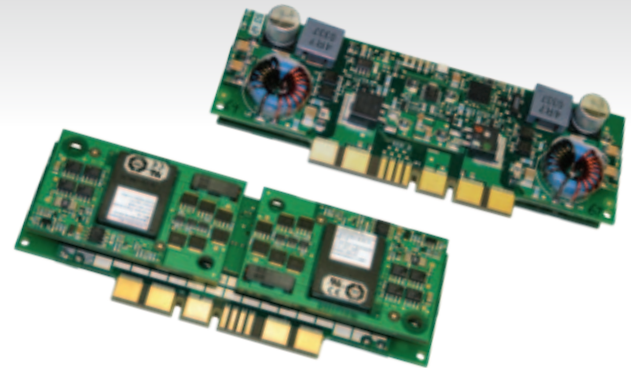

Facilities

GE Energy manufacturing strategy is to use the best of both internal and third party manufacturing, allowing us the flexibility to best fit each application's requirements. This approach presents an excellent value proposition with the flexibility to suit today's business environment.

GE Energy's commitment to manufacturing capabilities is deployed equally throughout our operations. The use of advanced equipment such as core bonding machines, HALT / HASS screening systems, AOI laser inspection machines, and highly advanced computer controller burn-in equipment are just a few examples of our capabilities.

Our manufacturing processes, quality systems, data collection, and documentation are standardized across all facilities ensuring a smooth transition among locations to accommodate optimal capacity utilization or proximity of supply close to our end customer manufacturing locations.

Cost challenges in our marketplace are paramount. In our business, a successful company is one that can tightly manage its cost structure with a major focus on managing its material. We employ a global procurement strategy tying all divisions together under one process reporting into corporate headquarters. We take great pride in managing a common AVL across all divisions, leveraging our cost structure with our vendor base. In the end, this contributes to competitive products with cost savings that provide an economical advantage for our customers.

Quality / Reliability

GE Energy employs a Global Total Quality Management System. All of our Quality Managers report to a Corporate Director of Quality, ensuring consistent measurement and collection of SPC data and deployment of controls of operation. From cradle to grave, GE Energy ensures quality principles that are used throughout its processes. Starting with the design and development phase, we apply stringent derating criteria of components and expose our designs to STRIFE and HALT testing. Our focus on reliability continues into production by using HASS screening and elevated temperature testing. Finally, we monitor the process using CPK and statistical analysis tools, forming a closed loop process.

All of our facilities are ISO 9001:2000 and ISO14001 Certified meeting the stringent guidelines for today's waste-free environment. We pride ourselves on employing a check and balance system that provides closed loop feedback to our manufacturing and engineering departments, ensuring continuous improvement. As adopters of the Six Sigma Training Program, we regularly produce green belt and black belt ratings for senior quality members.

As a leading power provider, we offer our customers low-risk, leading-edge technology and consistent, high-quality product, produced around the world with responsive and local support.



POL Voltage Setting & Tolerance Tool:

Helps designers set the output voltage of POL modules including: trim resistor values; worst case static variation in the output voltage for a trim resistor; calculating the values of margining resistors; and selecting the external series resistor to program the output voltage to desired nominal, low and high values.

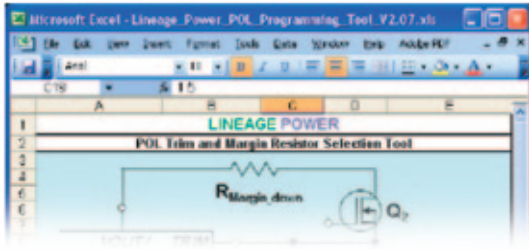

Tunable Loop™ Selection Tool:

The Tunable Loop™ helps designers select output capacitors, and values of C_{TUNE} and R_{TUNE} for Tunable Loop™ POLs for optimized performance and reduced output capacitance.

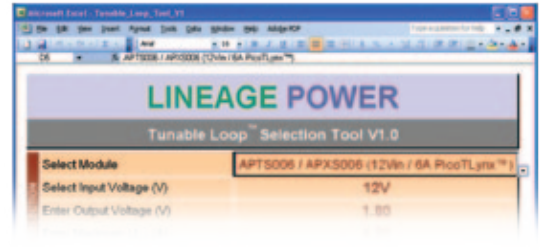

On-Line Power Module Selector

Helps select the best solutions to satisfy your power requirements. Simply provide your input range and output requirements. With this basic information, we provide a list of all possible solutions for side by side comparison with the ability to sort by size, efficiency and cost.

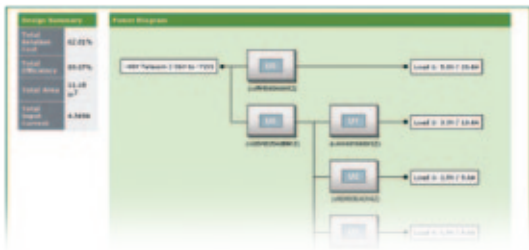

Power System Designer

With a little more application data such as maximum operating temperature, airflow and isolation, our Power System Designer can provide a complete engineering comparison for various architectures with block diagrams and product comparison charts (price, size and efficiency).



Stability Analysis Tool

Helps designers simulate a DC-DC converter and filter devices connected between the converter output and the load to identify and address issues early in the design process.

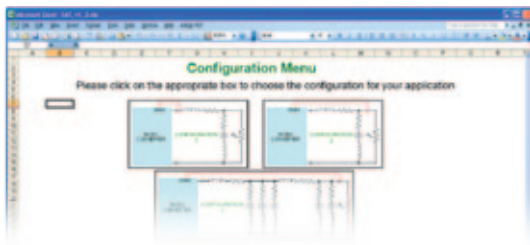

Evaluation Boards

Evaluation boards enable designers to evaluate the performance of our converters, either stand-alone or with our POL modules and optional input filters. Features such as on/off control, output voltage trim, and remote sense can be tested as well as external filtering components on both the input and output side.

Digital Power Insight™ GUI

Digital Power Insight™ GUI software package provides power engineers the flexibility to configure and reconfigure voltages, thresholds, warnings and settings for digital power modules using standards-based PMBus™ over I²C communications.

Our Lineage

Lineage Power, a GE Energy company, traces our nearly 100 year heritage of innovation to Bell Labs. We deliver reliable and intelligent power conversion solutions for cloud computing and mobile internet infrastructure with energy-efficient AC-DC power supplies, DC-DC circuit board mounted power modules, telecom energy systems, DC datacenters, and custom power products backed by local field expertise in 25+ locations worldwide. Designed for decades of non-stop operation, the high-availability Total Efficiency™ architecture DC power conversion solutions enable voice, video and data communications while assuring investment protection, total system efficiency, and significantly reduced total cost of ownership. Our customers include leading U.S. telecom service providers, such as AT&T, Verizon Wireless and Verizon, and leading global OEMs, such as Alcatel-Lucent, Cisco, Ericsson, Hewlett Packard, Huawei, Juniper Networks and Oracle. More information about Lineage hardware, software, services and training is available at www.ge.com/lineagepower.

OEM Embedded Power

Lineage Power offers end-to-end AC-DC and DC-DC power conversion solutions for Original Equipment Manufacturers (OEMs). We keep our customers ahead of their competitors by providing solutions that offer size, efficiency, and cost advantages while dramatically reducing risk through the utilization of proven, standards-based platforms.

The Lineage Power AC-DC custom power supply product line delivers custom, standard, and modified standard AC-DC frontends and rectifiers for datacom, telecom, medical, and industrial markets. Our personalized design assistance, sophisticated engineering, design flexibility, innovative solutions, and rapid prototype development distinguish us from our competitors and ensure we accelerate your time to market. Deep engineer-to-engineer relationships and our ability to optimize performance and reliability is balanced with cost sensitivity. We often act in a power consulting role enabling us to solve complex system issues beyond just the power supply.

With 30+ years of technology leadership, the Lineage Power DC-DC circuit board mounted power product line has been designed to provide highly reliable DC-DC conversion solutions to a wide array of applications in telecom, servers, storage, industrial, medical, and military markets. These isolated and non-isolated board mounted power (BMP) modules address the market's ever-evolving demand for smaller size and greater efficiency at a lower cost of ownership. Lineage Power was one of the cofounders of DOSA and remains an active leader in that continuous effort today to ensure that footprints and pin outs are compatible throughout the industry. Tunable Loop technology gives our customers a significant size and cost advantage over traditional capacitance designs.

Global Presence with offices around the world serving thousands of OEM Customers

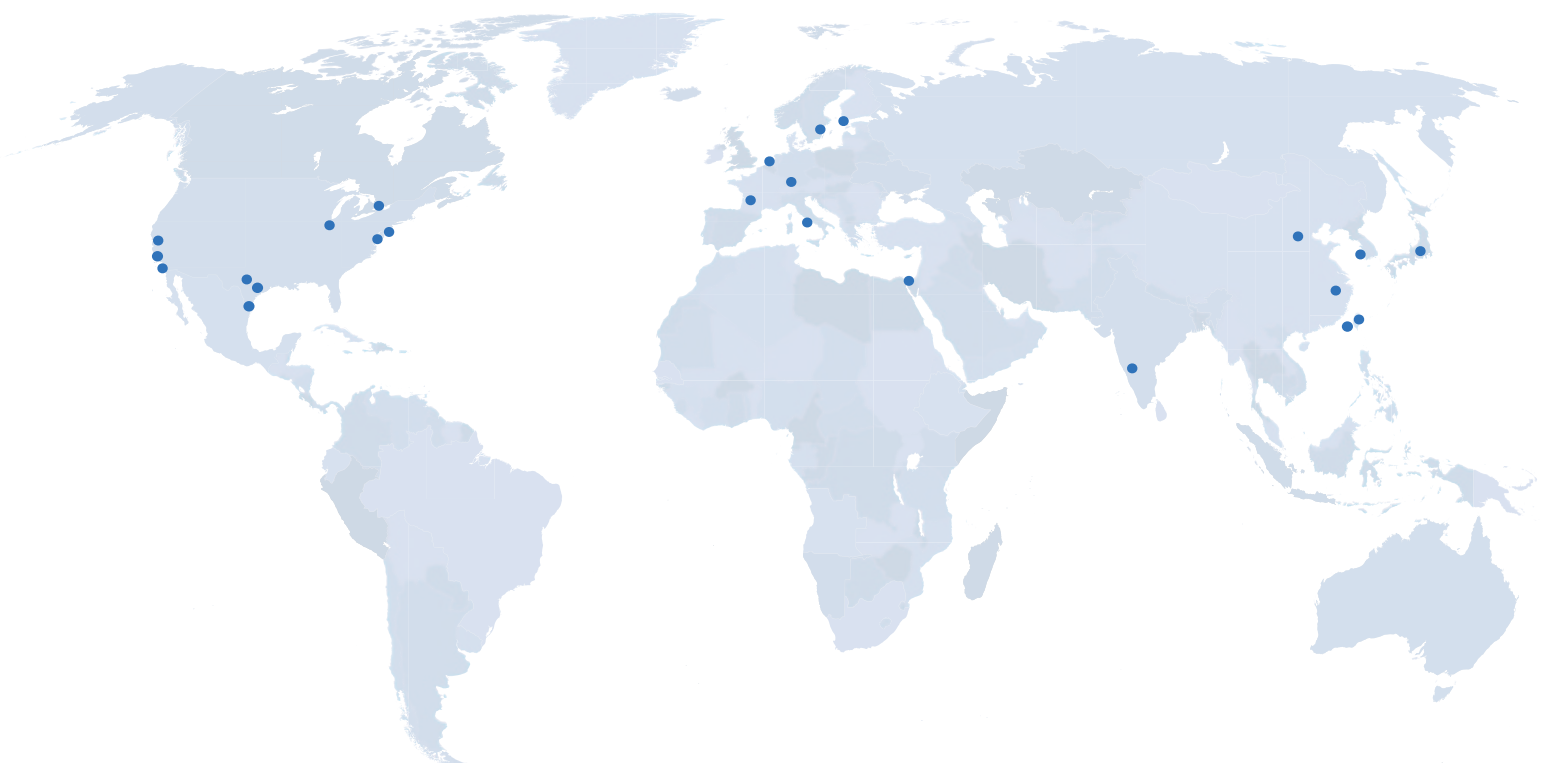

World Wide Headquarters

Lineage Power Corporation
601 Shiloh Road
Plano, TX 75074 USA
T: +1.972.244.WATT (9288)
T: 888.LINEAGE (546-3243)

Tustin, CA Design Center

T: +1.714.544 6665

techsupport1@lineagepower.com

European Headquarters

Lineage Power, GmbH
Biberger Str. 93
82008 Unterhaching
Germany
T: +49.89.878067-280

Asia Pacific Headquarters

Lineage Power (Shanghai) Co. Ltd.
3F, #9 Building, #456 Hong Cao Road
Shanghai 200233, China
T: +86.021.54279977*808

Beijing Office / T: +86.13910003797
Shenzhen Office / T: +86.755.26838194
Singapore Office / T: +65.6593.7200
Japan Office / T: +81.42.703.8009
India Office / T: +91.80.28411633

Lineage Power reserves the right to make changes to the product(s) or information contained herein without notice. No Liability is assumed as a result of their use or application. No rights under any patent accompany the sale of any such product(s) or information.

© 2011 Lineage Power Corporation, (Plano, Texas) All International Rights Reserved.
Lineage Power DC-DC products are protected under various patents. Information on these patents is available at www.lineagepower.com/patents



GE Energy