

### 2. High Frequency Use High-Q (Non Magnetic Core) QF, QE



#### ■ Features

- Capable of being Re-flow or flow soldered.
- Unique Ceramic Core/Laser-cut Technology.
- Non polarity product.
- High self resonance frequency.
- Good for mounting.
- RoHS compliant

#### ■ Recommended Applications

- RF circuitry for cellular phones and wireless communication equipment.

#### ■ Explanation of Part Numbers

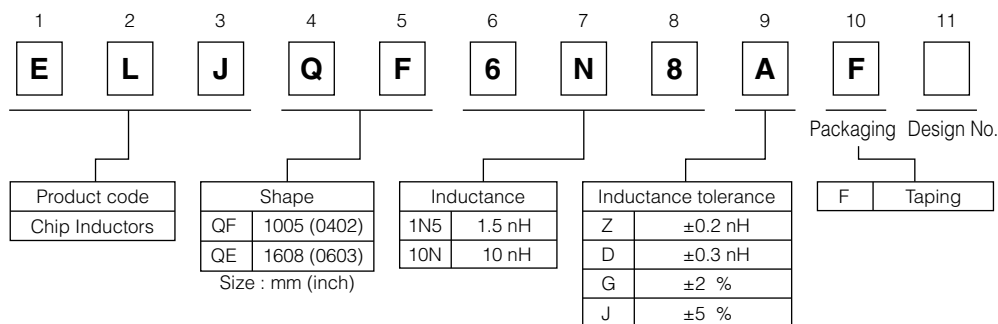

#### ■ Storage Conditions

- Package : Normal temperature (-5 to 35 °C), normal humidity (85 %RH max.), shall not be exposed to direct sunlight and harmful gases and care should be taken so as not to cause dew.
- Operating Temperature : -40 to +85 °C

#### ■ Storage Period

- Solderability may be reduced due to the conditions of high temperature and high humidity which causes the oxidation of tin-plated terminals. Even if storage conditions are within specified limits, solderability may be reduced with the passage of time. Therefore, please control the storage conditions and try to use the product within 6 months of receipt.

#### ■ Packaging Methods, Soldering Conditions and Safety Precautions

Please see Data Files.

### ■ QF Type 1005 (0402)

● Dimensions in mm (not to scale)

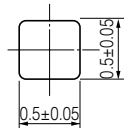
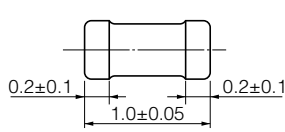

● Recommended Land Pattern in mm (not to scale)

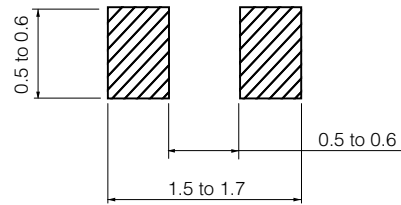

### ■ Standard Packing Quantity

● 10000 pcs./Reel

### ■ Standard Parts (E12 series)

Part No.	Inductance			Q		SRF *1 (MHz) min.	R <sub>DC</sub> *2 (Ω) max.	DC Current (mA) max.
	(nH)	Tolerance (%)	Test Freq. (MHz)	100 MHz min.	800 MHz typ.			
ELJQF1N0□F	1.0	D : ±0.3 nH Z : ±0.2 nH	100	10	41	6000	0.05	400
ELJQF1N2□F	1.2				41	6000	0.06	400
ELJQF1N5□F	1.5				40	6000	0.07	400
ELJQF1N8□F	1.8				40	6000	0.08	400
ELJQF2N2□F	2.2				40	6000	0.09	400
ELJQF2N7□F	2.7				40	5500	0.10	400
ELJQF3N3□F	3.3				39	5500	0.12	400
ELJQF3N9□F	3.9				39	5200	0.15	360
ELJQF4N7□F	4.7				39	4800	0.17	360
ELJQF5N6□F	5.6				39	4600	0.19	340
ELJQF6N8□F	6.8	J : ±5 % G : ±2 %	100	10	39	4000	0.30	320
ELJQF8N2□F	8.2				39	3500	0.35	320
ELJQF10N□F	10				39	2800	0.41	320
ELJQF12N□F	12				38	2800	0.45	320
ELJQF15N□F	15				36	2500	0.60	240
ELJQF18N□F	18				36	2200	0.70	240
ELJQF22N□F	22				36	2000	0.80	200
ELJQF27N□F	27				36	1800	1.20	200
ELJQF33N□F	33				35	1800	1.40	170
ELJQF39N□F	39				35	1800	1.70	150

□ : Symbol of Tolerance \*1 : Self Resonant Frequency \*2 : DC Resistance

### ■ Standard Parts (E24 series)

Part No.	Inductance			Q		SRF *1 (MHz) min.	R <sub>DC</sub> *2 (Ω) max.	DC Current (mA) max.
	(nH)	Tolerance (%)	Test Freq. (MHz)	100 MHz min.	800 MHz typ.			
ELJQF1N1□F	1.1	D : ±0.3 nH Z : ±0.2 nH	100	10	41	6000	0.06	400
ELJQF1N3□F	1.3				40	6000	0.07	400
ELJQF1N6□F	1.6				40	6000	0.08	400
ELJQF2N0□F	2.0				40	6000	0.09	400
ELJQF2N4□F	2.4				40	5500	0.10	400
ELJQF3N0□F	3.0				39	5500	0.12	400
ELJQF3N6□F	3.6				39	5300	0.14	380
ELJQF4N3□F	4.3				39	5000	0.16	360
ELJQF5N1□F	5.1				39	4700	0.18	350
ELJQF6N2□F	6.2				39	4300	0.25	330
ELJQF7N5□F	7.5	J : ±5 % G : ±2 %	100	10	39	3700	0.33	320
ELJQF9N1□F	9.1				39	3100	0.38	320
ELJQF11N□F	11				38	2800	0.43	320
ELJQF13N□F	13				36	2600	0.53	280
ELJQF16N□F	16				36	2300	0.65	240
ELJQF20N□F	20				36	2100	0.75	220
ELJQF24N□F	24				36	1900	1.00	200
ELJQF30N□F	30				35	1800	1.30	190
ELJQF36N□F	36				35	1800	1.60	160

□ : Symbol of Tolerance \*1 : Self Resonant Frequency \*2 : DC Resistance

Design and specifications are each subject to change without notice. Ask factory for the current technical specifications before purchase and/or use. Should a safety concern arise regarding this product, please be sure to contact us immediately.

### ■ ELJQF Type

### ■ Typical Characteristics

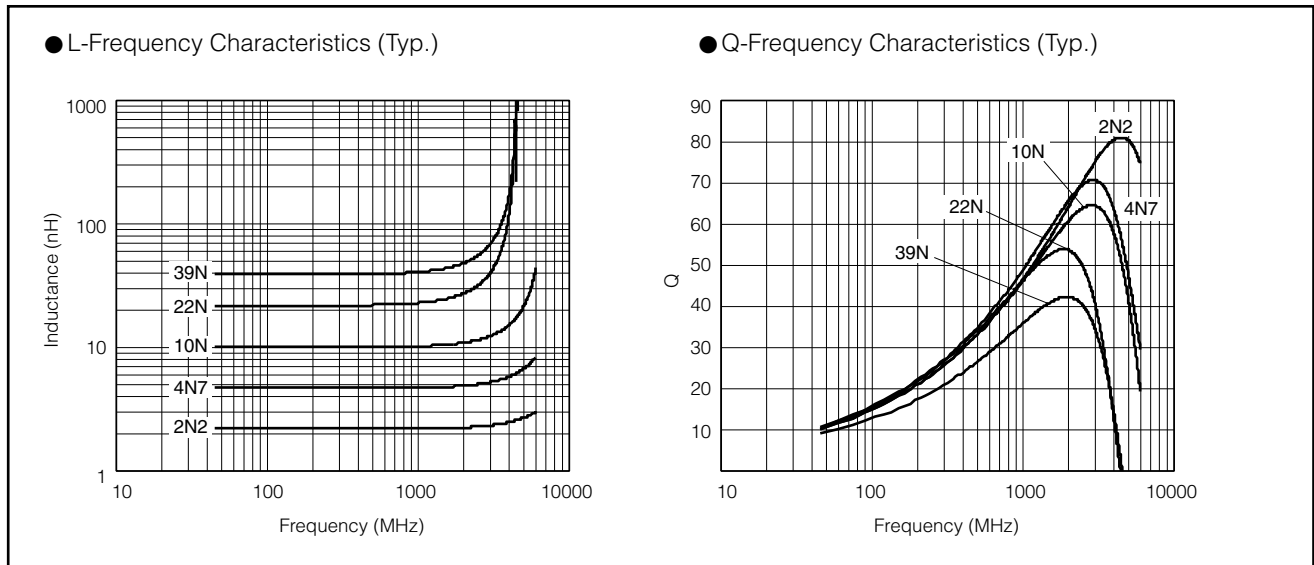

### ■ Reference Data

Part No.	Inductance (nH)(Typ.)					Q(Typ.)				
	800MHz	900MHz	1.8GHz	2.0GHz	2.4GHz	800MHz	900MHz	1.8GHz	2.0GHz	2.4GHz
ELJQF1N0□F	1.00	1.00	1.01	1.01	1.02	42.8	46.1	64.1	67.7	73.6
ELJQF1N2□F	1.20	1.21	1.22	1.22	1.23	44.4	47.1	65.8	69.0	75.1
ELJQF1N5□F	1.51	1.51	1.53	1.53	1.55	43.7	46.4	64.5	67.6	73.3
ELJQF1N8□F	1.78	1.78	1.81	1.82	1.84	40.0	42.4	58.8	61.5	66.6
ELJQF2N2□F	2.19	2.19	2.24	2.25	2.28	41.9	44.5	61.4	64.2	69.3
ELJQF2N7□F	2.73	2.73	2.79	2.81	2.85	46.3	49.1	67.7	70.7	76.2
ELJQF3N3□F	3.32	3.33	3.40	3.43	3.48	47.2	50.0	68.8	71.8	77.1
ELJQF3N9□F	3.98	3.99	4.11	4.15	4.24	43.0	45.6	62.0	64.4	68.4
ELJQF4N7□F	4.70	4.71	4.86	4.91	5.02	44.1	46.8	63.2	65.6	69.1
ELJQF5N6□F	5.59	5.60	5.80	5.87	6.02	44.2	46.9	63.6	66.1	70.3
ELJQF6N8□F	6.82	6.84	7.13	7.22	7.46	42.6	45.1	60.4	62.5	65.4
ELJQF8N2□F	8.33	8.35	8.76	8.89	9.22	41.3	43.7	58.2	60.0	62.3
ELJQF10N□F	10.14	10.18	10.76	10.94	11.42	41.8	44.2	58.8	60.8	63.5
ELJQF12N□F	12.0	12.1	12.9	13.2	13.9	44.1	46.7	59.9	61.0	60.9
ELJQF15N□F	15.2	15.3	16.7	17.2	18.4	42.3	44.6	56.2	56.8	55.7
ELJQF18N□F	18.3	18.4	20.2	20.8	22.5	43.4	45.7	55.8	55.5	52.1
ELJQF22N□F	22.5	22.8	26.2	27.4	30.9	42.4	44.6	53.8	53.7	50.8
ELJQF27N□F	27.8	28.1	33.3	35.3	41.2	39.6	41.6	48.8	48.1	44.1
ELJQF33N□F	33.7	34.0	38.4	40.0	44.3	35.6	37.4	45.4	45.3	42.9
ELJQF39N□F	40.1	40.5	46.2	48.2	53.9	32.8	34.5	42.2	42.3	40.9

□ : Symbol of Tolerance

### ■ QE Type 1608 (0603)

● Dimensions in mm (not to scale)

● Recommended Land Pattern in mm (not to scale)

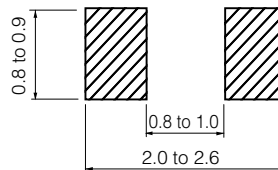
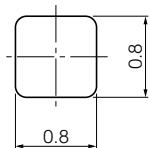
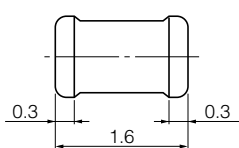

### ■ Standard Packing Quantity

● 3000 pcs./Reel

### ■ Standard Parts (E12 series)

Part No.	Inductance			Q		SRF *1 (MHz) min.	R <sub>DC</sub> *2 (Ω) max.	DC Current (mA) max.	
	(nH)	Tolerance (%)		100 MHz min.	800 MHz typ.				
ELJQE2N2□FA	2.2	D : ±0.3 nH	Z : ±0.2 nH	100	15	88.6	6000	0.04	970
ELJQE2N7□FA	2.7					65.4	6000	0.05	880
ELJQE3N3□FA	3.3					61.3	6000	0.06	800
ELJQE3N9□FA	3.9					68.4	6000	0.07	750
ELJQE4N7□FA	4.7					65.2	6000	0.09	660
ELJQE5N6□FA	5.6					57.4	6000	0.11	600
ELJQE6N8□FA	6.8	J : ±5 %	G : ±2 %	100	15	65.0	6000	0.14	540
ELJQE8N2□FA	8.2					65.5	5700	0.17	490
ELJQE10N□FA	10					63.8	5300	0.21	450
ELJQE12N□FA	12					61.9	4900	0.26	400
ELJQE15N□FA	15					59.0	4400	0.34	350
ELJQE18N□FA	18					58.6	4000	0.41	320
ELJQE22N□FA	22					59.1	3700	0.52	290
ELJQE27N□FA	27					55.0	3400	0.66	260
ELJQE33N□FA	33					54.2	3000	0.82	230
ELJQE39N□FA	39					52.9	2800	1.00	210
ELJQE47N□FA	47	54.4	2500	1.23	190				
ELJQE56N□FA	56	51.5	2500	1.51	180				

□ : Symbol of Tolerance      \*1 : Self Resonant Frequency      \*2 : DC Resistance

### ■ ELJQE Type

### ■ Typical Characteristics

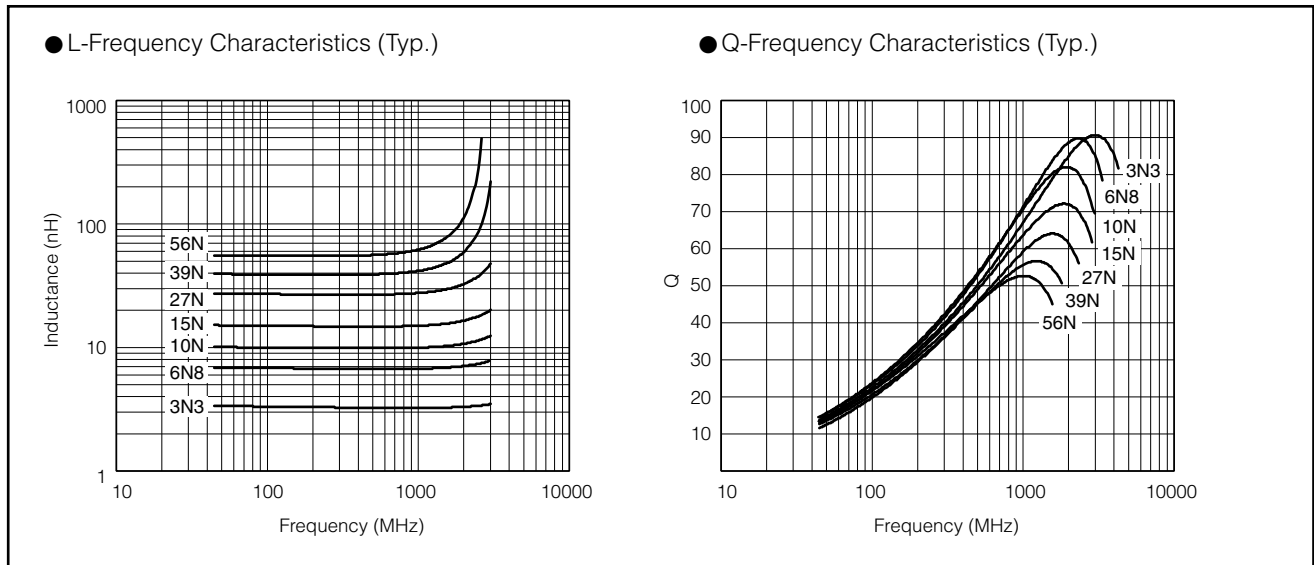

### ■ Reference Data

Part No.	Inductance (nH)(Typ.)					Q(Typ.)				
	800MHz	900MHz	1.8GHz	2.0GHz	2.4GHz	800MHz	900MHz	1.8GHz	2.0GHz	2.4GHz
ELJQE2N2□FA	2.18	2.18	2.23	2.25	2.30	88.6	92.5	117.0	119.5	122.5
ELJQE2N7□FA	2.62	2.62	2.69	2.71	2.78	65.4	68.4	87.2	89.3	92.4
ELJQE3N3□FA	3.24	3.24	3.29	3.30	3.36	61.3	64.2	82.6	84.9	88.7
ELJQE3N9□FA	3.83	3.83	3.91	3.93	4.01	68.4	71.9	94.8	97.6	102.1
ELJQE4N7□FA	4.61	4.61	4.74	4.78	4.91	65.2	68.4	88.3	90.4	93.0
ELJQE5N6□FA	5.48	5.48	5.62	5.67	5.82	57.4	60.1	77.2	79.2	82.0
ELJQE6N8□FA	6.70	6.71	6.96	7.05	7.30	65.0	68.2	87.0	88.6	89.7
ELJQE8N2□FA	8.12	8.14	8.57	8.71	9.12	65.5	68.4	84.0	84.7	83.5
ELJQE10N□FA	9.89	9.92	10.5	10.7	11.3	63.8	66.7	81.5	82.1	80.5
ELJQE12N□FA	12.0	12.0	12.9	13.1	14.0	61.9	64.6	77.8	78.0	75.4
ELJQE15N□FA	14.9	14.9	16.1	16.4	17.6	59.0	61.4	72.1	72.0	69.0
ELJQE18N□FA	18.0	18.1	20.1	20.8	22.9	58.6	61.0	70.1	69.2	64.0
ELJQE22N□FA	22.0	22.1	24.9	25.9	29.0	59.1	61.3	67.8	66.1	59.0
ELJQE27N□FA	27.1	27.3	31.2	32.5	36.7	55.0	57.2	63.3	61.6	54.3
ELJQE33N□FA	33.9	34.4	43.7	47.4	61.4	54.2	55.9	54.7	51.0	39.1
ELJQE39N□FA	40.3	40.9	53.6	58.9	79.9	52.9	54.4	50.6	46.3	33.2
ELJQE47N□FA	49.6	50.5	72.7	83.1	134.8	54.4	55.4	44.2	38.1	21.6
ELJQE56N□FA	58.8	60.1	93.6	111.2	223.8	51.5	52.3	37.7	30.9	13.6

□ : Symbol of Tolerance