

TECHNICAL DATA *Press-Fit Insulated Terminals*

Press-Fit Terminals have outstanding electrical, mechanical, thermal and chemical properties made possible through the use of uncontaminated ptfе resin - long known for its exceptional inherent physical properties - as well as close fabrication control. The highest production standards are assured because quality control at ITT Sealectro is based on United Kingdom Ministry specifications and methods and these inspection procedures are carried on from receipt of the ptfе right down to the assembled terminals.

Characteristics of ptfе

Electrical Properties

Volume Resistivity (50% RH, 23°C)	10 ¹⁸ ohm/cm
Dielectric Constant (60 Hz to 10 ⁶ Hz)	2.0-2.2
Dielectric Strength (volts/mil)	400-450
Dissipation (power) Factor (60 Hz to 10 ⁶ Hz)	0.0002
Corona Resistance (see ratings in tables)	No tracking or carbonizing
Capacitance (see ratings in tables)	Very low

Mechanical Properties

Tensile Strength	1500-2500 psi (105 kgf/cm ² - 175 kgf/cm ²)
Elongation	75-150%
Modulus of Elasticity	50000-55000 psi (3500 kgf/cm ² - 3850 kgf/cm ²)

Chemical Properties

Resistant to all acids and alkalis of all concentrations, as well as to all common solvents, fungus and rot.

Water absorption [24 hour immersion 1/8" (3.175) thickness]	0.01%
Burning Rate	None
Effect of Sunlight, Ultra-violet and Infra-red light	None
Temperature Range (not affected by soldering operations or cryogenic environs)	-100°C to +250°C (-148°F to +482°F)

Testing Data

Capacitance and voltage measured with terminals installed in chassis permitting 0.040" (1.016) protrusion of the ptfе bushing but not more than 0.050" (1.27) thick.

Note: While the above values are typical of the materials used, they should not be quoted on users specifications or drawings of ITT Sealectro Insulated Terminals

Plating

Standard plating code for the lug portion of each terminal is given in the 13th & 14th digits of the part number.

20	Gold flash 0.000005" (0.13 micron) min. over silver 0.0003" (7.62 micron) min.
51	Greville Tinned to ITT Sealectro specification A0143502
59	Bright acid tin 0.0003" (7.62 micron) min. over 0.0002" (5.08 micron) min. copper
60	Silver 0.0002" (5.08 micron) over copper flash.

Bushing Colour

All terminals are manufactured with white ptfе

Dimensions

All dimensions are in inches with metric equivalents given in brackets or green throughout.

INSTALLATION PROCEDURE

Press-Fit Insulated Terminals

The Press-Fit method is the simplest, fastest, most economical terminal installation, with practically no restriction as to chassis material and thickness. The procedure is further simplified by the use of Insertion Tools available from ITT Sealectro. These inexpensive tools are designed to fit any drill press or hand-arbor press.

Recommended Insertion Tools for each terminal are listed in the first column following the terminal part number on each table in the catalogue.

(1) PUNCH OR DRILL HOLE in chassis $0.013" + 0.002$ (0.05) less than diameter of terminal section (dia G in tables) passing through chassis. Minimum protrusion of bushing passing through chassis $0.040"$ (1.0). Maximum thickness of chassis $0.125"$ (3.18); for greater thickness ask for our recommendations. Countersink from breakout or die side of chassis (not from punch side)

(2) COUNTERSINK ENTRANCE EDGE ...Use 60° countersink when chassis thickness is $0.040"$ (1.0) and over; use 82° countersink when chassis thickness is less than $0.040"$ (1.0). This enables centring of terminal in hole and prevents scoring the ptfе bushing. Depth and maximum diameter of countersink is determined by thickness of chassis stock and bushing's major diameter.

(3) INSERTION TOOL.... Insertion tool is placed in chuck of drill press (power off) or hand arbor press. Terminal is held by tool, leaving assembler's hands free to index and centre chassis hole underneath tool. Proper pressure is applied and released just as soon as major diameter of terminal seats itself.

Bushing Minor Dia. (Dia "G" in tables)		Hole or punch Dia. "A" $\pm 0.002"$ (± 0.05)		Countersink Dia. "B" $+0.010" - 0.000"$ ($+0.25 - 0.00$)	
.075	1.90	.070	1.78	.083 ^{+0.005} _{-0.000}	2.11 ^{+0.13} _{-0.00}
.093	2.36	.086	2.18	.110	2.79
.104	2.64	.091	2.31	.115	2.92
.125	3.18	.113	3.87	.135	3.43
.148	3.76	.136	3.45	.160	4.06
.165	4.19	.152	3.86	.175	4.45
.171-.172	4.34-4.37	.158	4.01	.175	4.45
.185	4.70	.172	4.37	.195	4.95
.217-.218	5.51-5.54	.205	5.21	.235	5.97
.256	6.50	.243	6.17	.269	6.83
.290	7.37	.277	7.04	.305	7.75
.373	9.48	.360	9.15	.380	9.65
.513	13.03	.500	12.70	.537	13.64

Use 60° countersink for chassis thickness $.040"$ (1.0) and over

Use 82° countersink for chassis thickness under $.040"$ (1.0)

Punched & Drawn hole

Punch & Countersink Detail

Dim "A" $+0.0000$ (0.00) -0.0005 (0.13)

Draw Punch & Die Detail

See Note 4

NOTES

- Ptfe should protrude $.040"$ (1.0) min below chassis
- Clearance between punch & die should be held to normal shop tolerances governed by material & thickness & type
- Predrawn hole size is governed by material type & thickness
- Die diameter is punch diameter plus double the metal thickness, tolerances being consistent with normal shop practice.

STEP DRILLS

Drill and countersink in one operation

ITT Sealectro Part No. (See table)

Dim A

Dim B

Dim C (incl angle)

Dim D

Part No.	A	B*	C ⁰	D
086-115-60	.086 2.18	.115 2.92	60	.187 4.75
136-160-60	.136 3.45	.160 4.06	60	.187 4.75
136-160-82	.136 3.45	.160 4.06	82	.187 4.75
152-175-60	.152 3.86	.175 4.45	60	.187 4.75
158-175-60	.158 4.01	.175 4.45	60	.187 4.75
172-195-60	.172 4.37	.195 4.95	60	.250 6.35
205-235-60	.205 5.21	.235 5.97	60	.250 6.35

Note: B* is recommended diameter of countersink $+0.010$ (0.25) -0.000 (0.00)

STAND OFFS Press-Fit Terminals

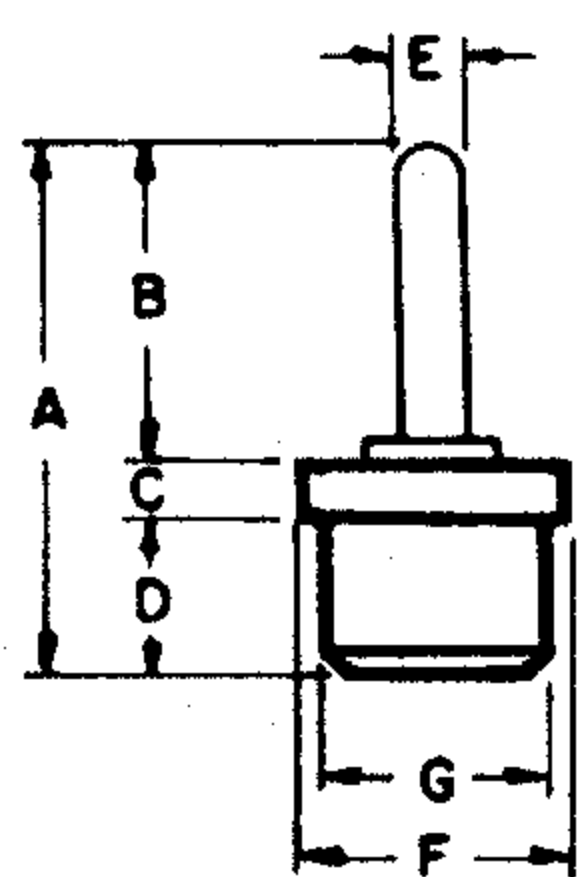

Fig 1

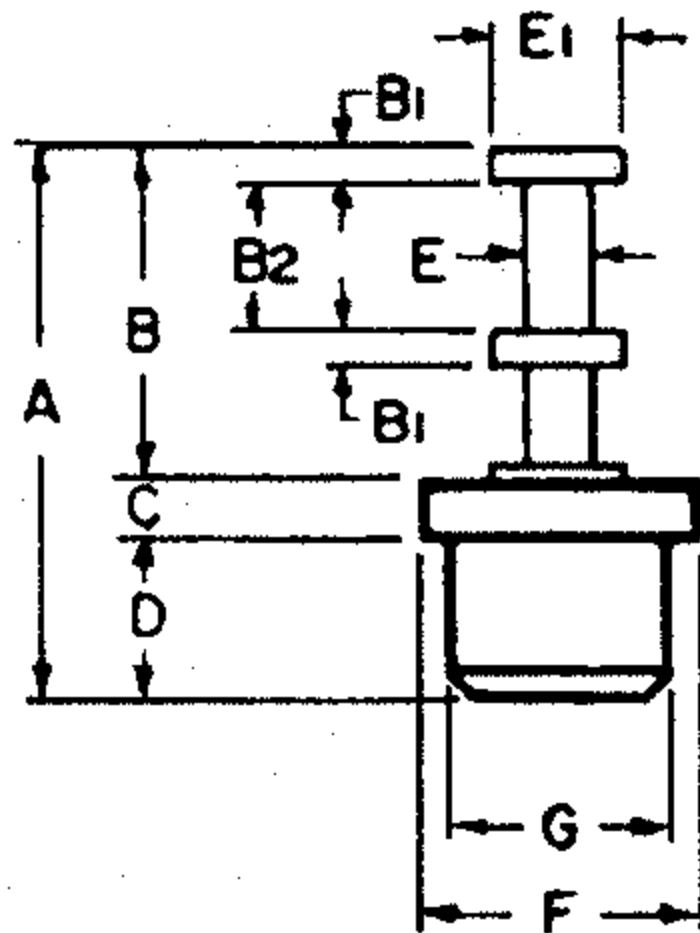

Fig 2

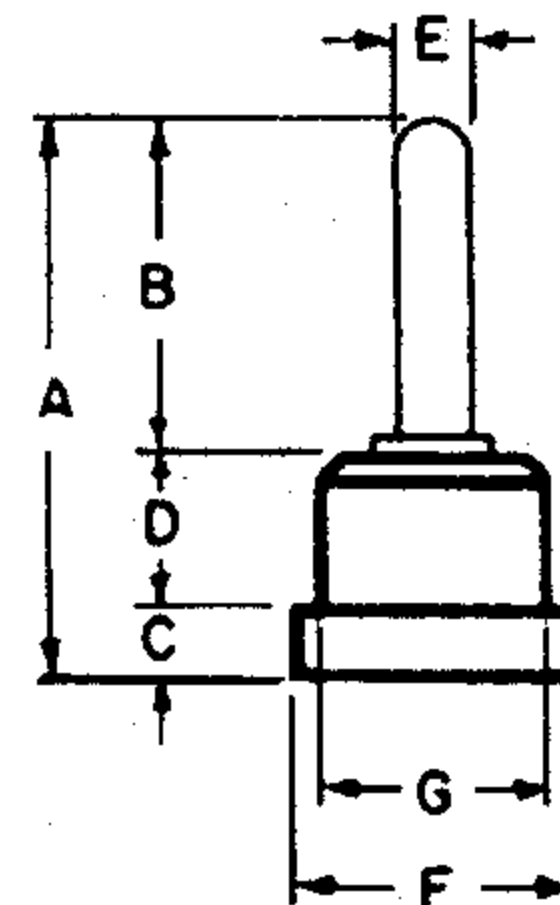

Fig 3

Fig	Part No.	Tool No.	Approx Capacitance mmf	V RMS 50Hz		A	B	B1	B2	C	D	E Dia	E1 Dia	F Dia	G * Dia
				Nominal Rating	Flashover Sea Level										
1	013-1000-040519	B-8	0.45	1000	3000	.350 8.9	.210 5.3			.040 1.0	.100 2.5	.040 1.0		.172 4.4	.148 3.76
2	013-2001-040519	B-8	0.40	1000	3000	.350 8.9	.210 5.3	.020 0.5	.100 2.5	.040 1.0	.100 2.5	.040 1.0	.080 2.0	.172 4.4	.148 3.76
2	013-2003-040519	B-8	0.50	1000	3000	.375 9.5	.210 5.3	.020 0.5	.100 2.5	.040 1.0	.125 3.2	.040 1.0	.080 2.0	.172 4.4	.148 3.76
1	013-1019-040519	B-15	0.45	1000	3000	.350 8.9	.210 5.3			.040 1.0	.100 2.5	.040 1.0		.195 5.0	.172 4.37
1	003-1009-040519	B3-1	0.60	1000	3000	.350 8.9	.210 5.3			.040 1.0	.100 2.5	.040 1.0		.125 3.2	.093 2.36
2	003-2003-040519	B3-2B	0.60	1000	3000	.350 8.9	.210 5.3	.020 0.5	.100 2.5	.040 1.0	.100 2.5	.040 1.0	.080 2.0	.125 3.2	.093 2.36
3	014-1001-040519	B8-G	0.40	1200	3500	.330 8.4	.210 5.3			.020 0.5	.100 2.5	.040 1.0		.125 3.2	.093 2.36
3	004-1007-040519	B3-2X	0.40	1000	3000	.350 8.9	.210 5.3			.040 1.0	.100 2.5	.040 1.0		.172 4.4	.148 3.76

*+.002(0.05) -.000(0.00)

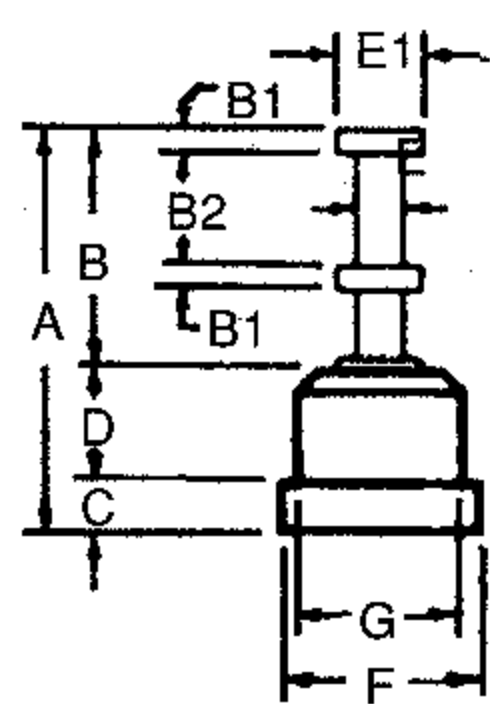

Fig 4

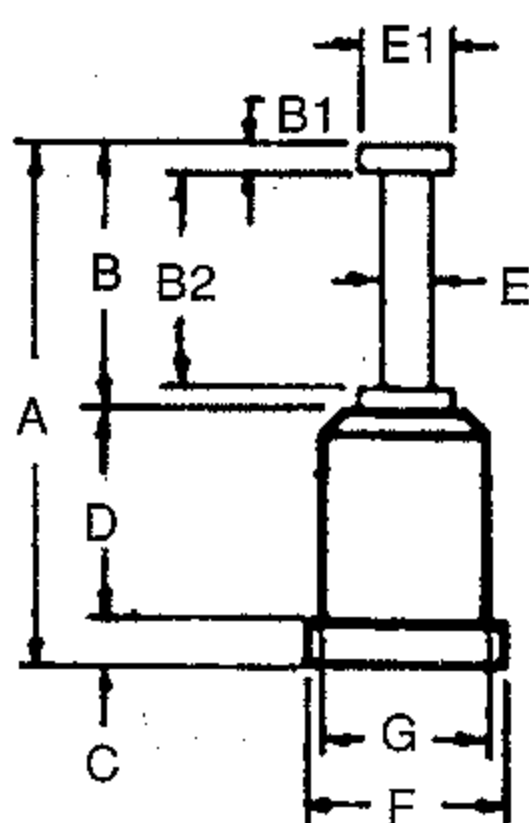

Fig 5

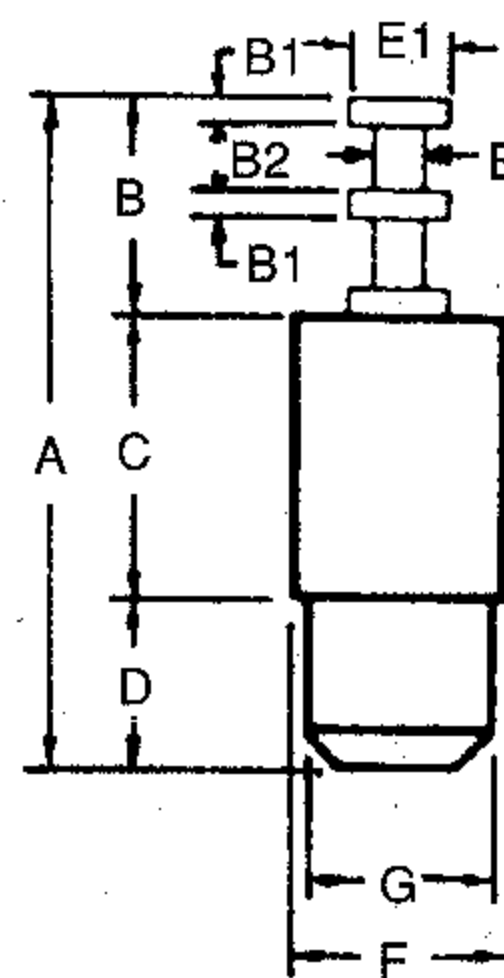

Fig 6

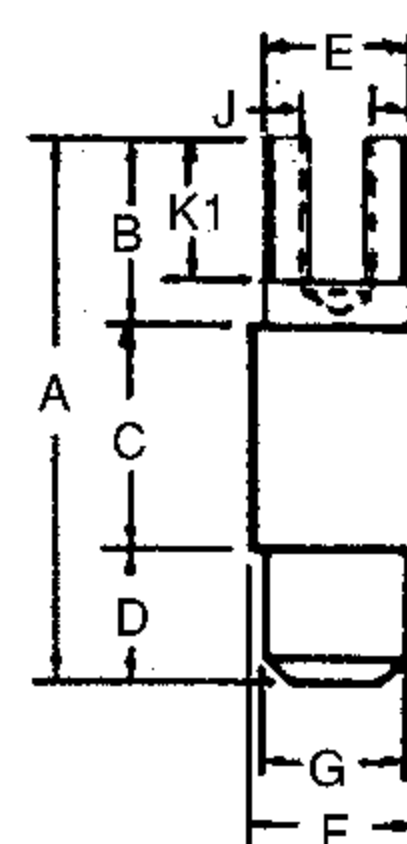

Fig 7

Fig	Part No	Tool No.	Approx Capacitance mmf	V RMS 50Hz		A	B	B1	B2	C	D	E Dia	E1 Dia	F Dia	G * Dia	J Dia	K1
				Nominal Rating	Flashover Sea Level												
4	014-2001-040519	B8-X-1	0.40	1200	3500	.350 8.9	.210 5.3	.020 0.5	.100 2.5	.040 1.0	.100 2.5	.040 1.0	.080 2.0	.172 4.4	.148 3.76		
5	014-2011-040519	B8-X-1	0.50	1700	4500	.455 11.5	.227 5.8	.020 0.5	.187 4.8	.040 1.0	.187 4.8	.040 1.0	.080 2.0	.172 4.4	.148 3.76		
6	013-2046-040609	B12	0.30	2500	6000	.431 10.9	.156 4.0	.020 0.5	.046 1.2	.125 3.2	.150 3.8	.046 1.2	.093 2.4	.187 4.8	.165 4.19		
7	013-3005-040609	B11	0.70	2000	5000	.478 12.1	.203 5.2			.125 3.2	.150 3.8	.148 3.8		.187 4.8	.171 4.34	.078 2.0	.156 4.0
7	013-3007-040519	B11	0.70	2300	5600	.540 13.7	.203 5.2			.187 4.8	.150 3.8	.148 3.8		.187 4.8	.171 4.34	.078 2.0	.156 4.0

*+.002(0.05) -.000(0.00)

FEED-THROUGHS *Press-Fit Terminals*

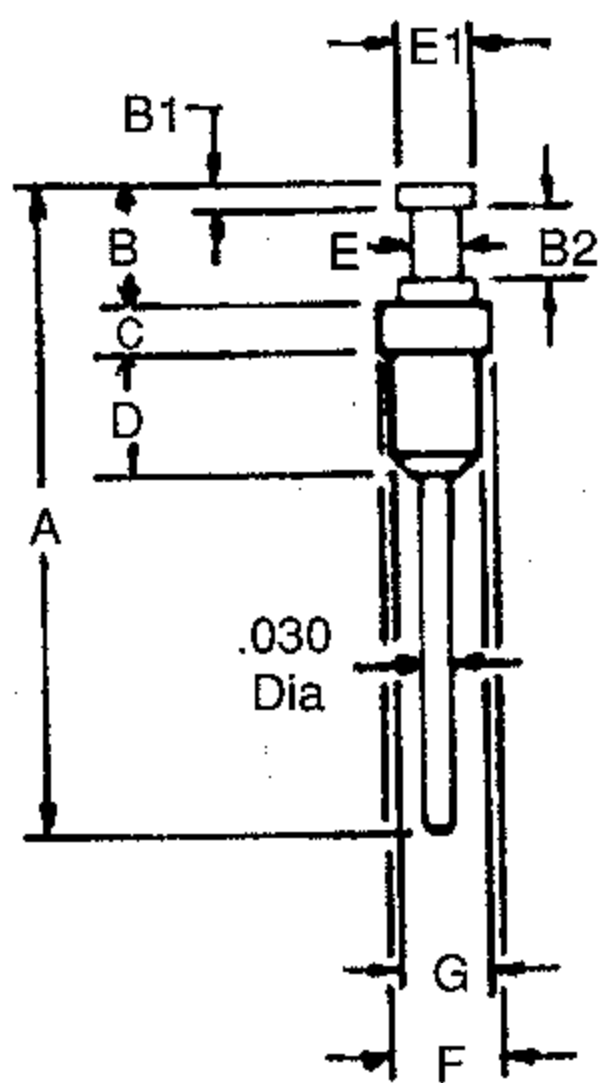

Fig 8

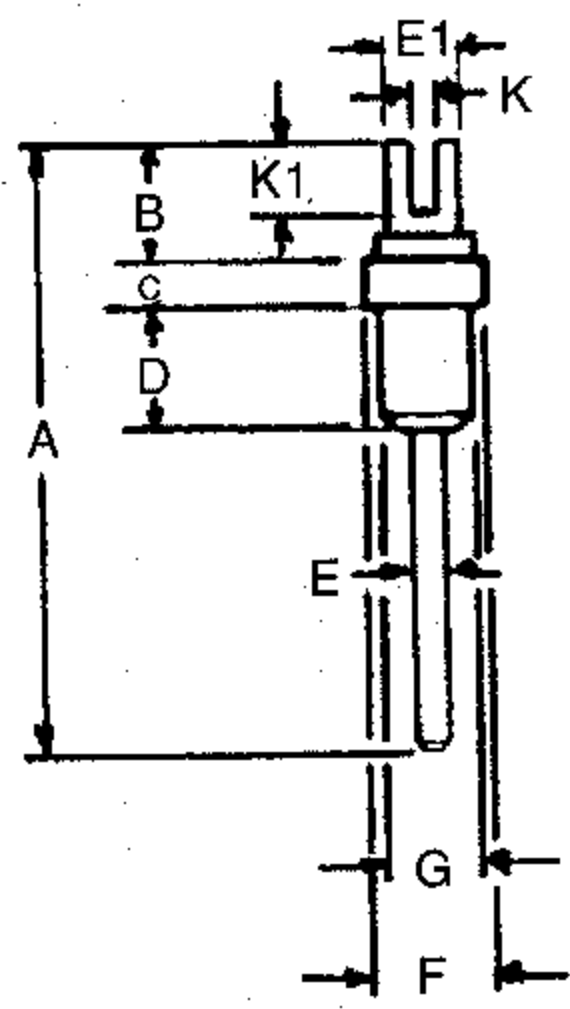

Fig 9

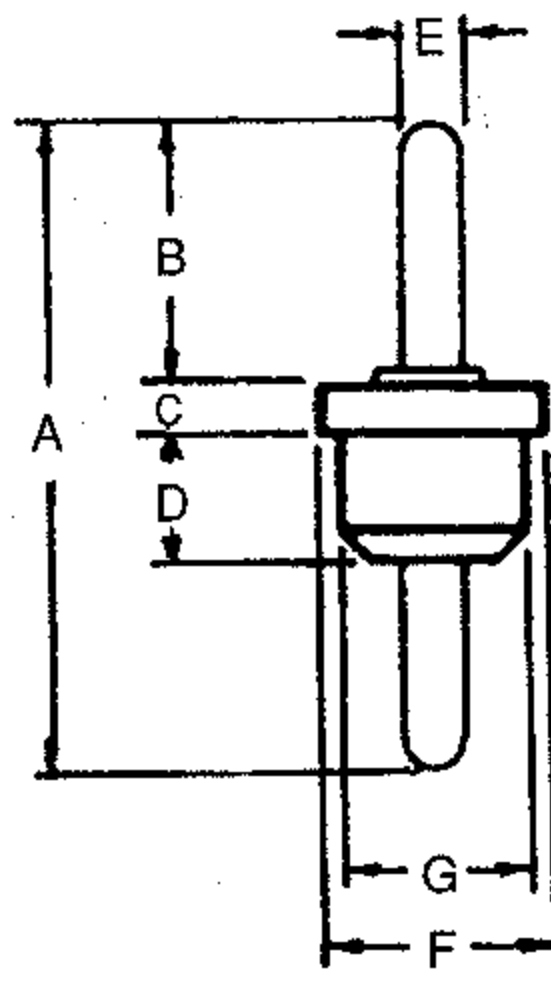

Fig 10

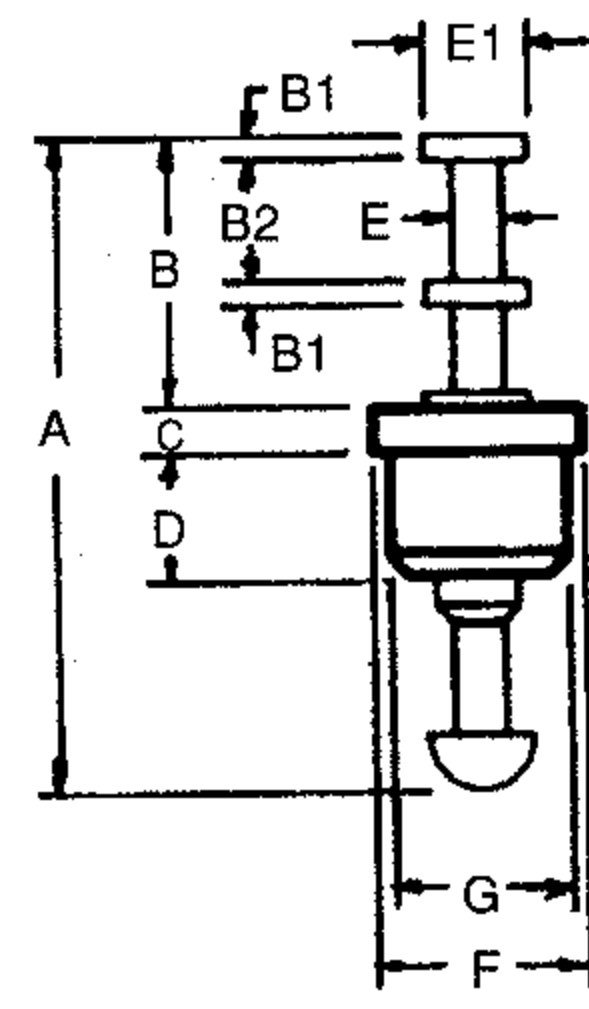

Fig 11

Fig	Part No.	Tool No.	Approx Capacitance mmf	V RMS 50Hz		A	B	B1	B2	C	D	E Dia	E1 Dia	F Dia	G *	K	K1
				Nominal Rating	Flashover Sea Level												
8	001-2013-040519	B0	0.70	400	1800	.510 13.0	.100 2.5	.020 0.5	.060 1.5	.040 1.0	.100 2.5	.040 1.0	.060 1.5	.093 2.4	.075 1.91		
9	001-3012-040519	B0-1	0.70	400	1800	.510 13.0	.100 2.5			.040 1.0	.100 2.5	.030 0.8	.060 1.5	.093 2.4	.075 1.91	.024 0.6	.080 2.0
10	001-1038-040519	B0-2	0.70	400	1800	.550 14.0	.275 7.0			.040 1.0	.100 2.5	.030 0.8		.093 2.4	.075 1.91		
10	011-1004-040519	B8-16	0.50	1000	3000	.515 13.1	.210 5.3			.040 1.0	.100 2.5	.040 1.0		.172 4.4	.148 3.76		
10	011-4021-040519	B8-16	0.50	1000	3000	.375 9.5	.125 3.2			.040 1.0	.100 2.5	.040 1.0		.172 4.4	.148 3.76		
10	001-1007-040519	B3-1	0.75	500	2000	.515 13.1	.210 5.3			.040 1.0	.100 2.5	.040 1.0		.125 3.2	.093 2.36		
11	001-2004-040519	B-3-2B	0.70	500	2000	.500 12.7	.210 5.3	.020 0.5	.100 2.5	.040 1.0	.100 2.5	.040 1.0	.080 2.0	.125 3.2	.093 2.36		
11	011-2004-040519	B8	0.50	1000	3000	.500 12.7	.210 5.3	.020 0.5	.100 2.5	.040 1.0	.100 2.5	.040 1.0	.080 2.0	.172 4.4	.148 3.76		
11	011-2023-040519	B9	0.65	1200	3500	.609 15.5	.210 5.3	.020 0.5	.100 2.5	.093 2.4	.125 3.2	.040 1.0	.080 2.0	.172 4.4	.148 3.76		

* +.002(0.05) -.000(0.00)

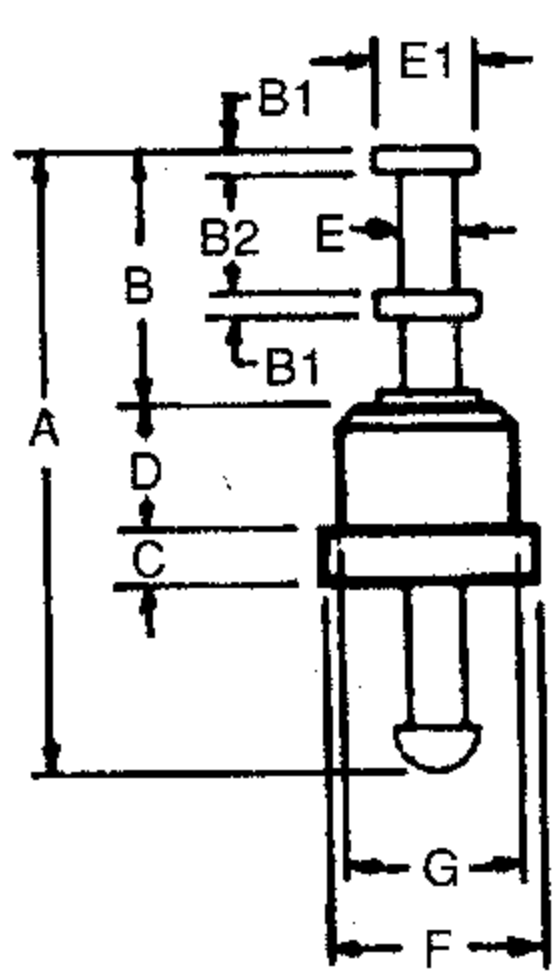

Fig 12

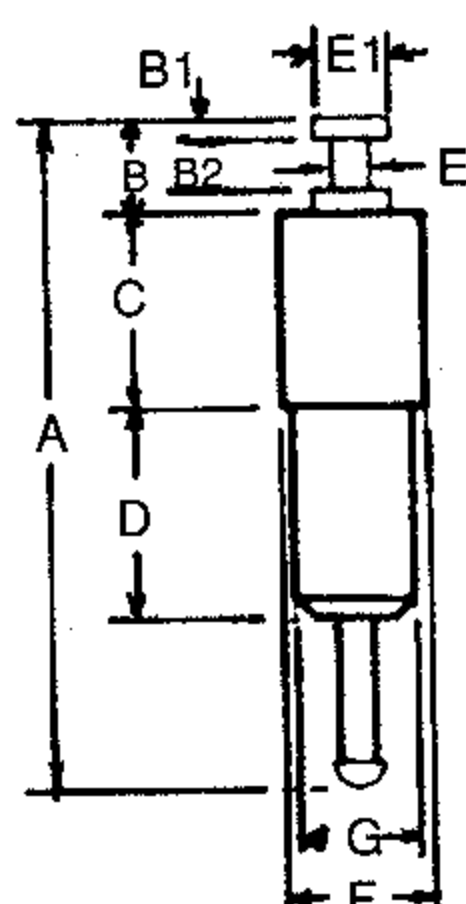

Fig 13

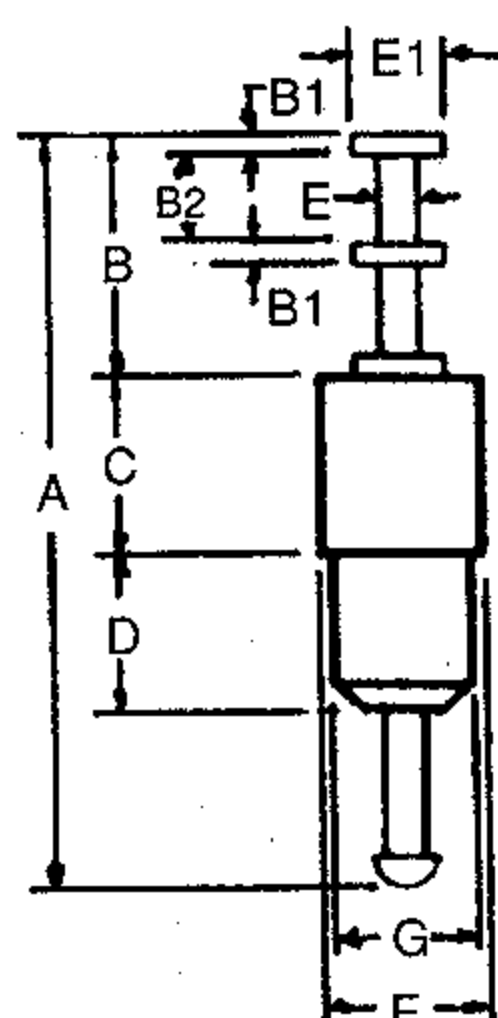

Fig 14

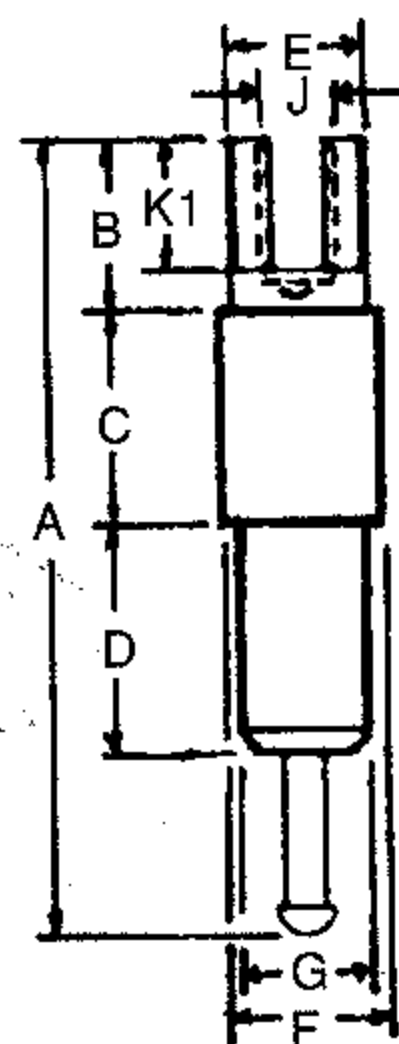

Fig 15

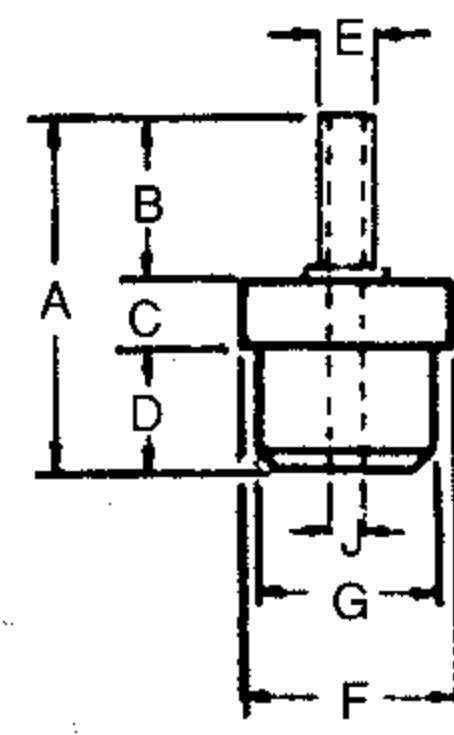

Fig 16

Fig	Part No	Tool No.	Approx Capacitance mmf	V RMS 50Hz		A	B	B1	B2	C	D	E Dia	E1 Dia	F Dia	G *	J	K1
				Nominal Rating	Flashover Sea Level												
12	012-2000-040519	B8	0.50	1000	3000	.500 12.7	.210 5.3	.020 0.5	.100 2.5	.040 1.0	.100 2.5	.040 1.0	.080 2.0	.172 4.4	.148 3.76		
13	011-2049-040519	B10	0.75	1700	4500	.540 13.7	.133 3.4	.020 0.5	.093 2.4	.063 1.6	.171 4.3	.046 1.2	.093 2.4	.187 4.8	.171 4.34		
13	011-2062-040519	B13	0.70	2200	5500	.740 18.8	.125 3.2	.031 0.8	.062 1.6	.187 4.8	.212 5.4	.050 1.3	.093 2.4	.187 4.8	.171 4.34		
15	011-3014-040519	B11	0.80	2000	5000	.821 20.9	.203 5.2			.187 4.8	.212 5.4	.148 3.8		.187 4.8	.171 4.34	.078 2.0	.156 4.0
14	011-2064-040519	B13-3B	0.80	2000	5000	.836 21.2	.250 6.4	.020 0.5	.093 2.4	.187 4.8	.212 5.4	.050 1.3	.093 2.4	.187 4.8	.171 4.34		
13	011-2072-040519	B12-3	0.70	3000	7000	.865 22.0	.125 3.2	.031 0.8	.062 1.6	.250 6.4	.275 7.0	.050 1.3	.093 2.4	.187 4.8	.171 4.34		
16	001-6033-040519	B3-1	0.40	500	2000	.225 5.7	.125 3.2			.040 1.0	.060 1.5	.040 1.0		.125 3.2	.093 2.36	.030 0.3	
16	011-6015-040519	B8-13A	0.75	750	2500	.367 9.3	.207 5.3			.050 1.3	.110 2.8	.085 2.2		.172 4.4	.148 3.76	.063 1.6	

* +.002(0.05) -.000(0.00)

TEST POINT JACKS

Press-Fit Terminals

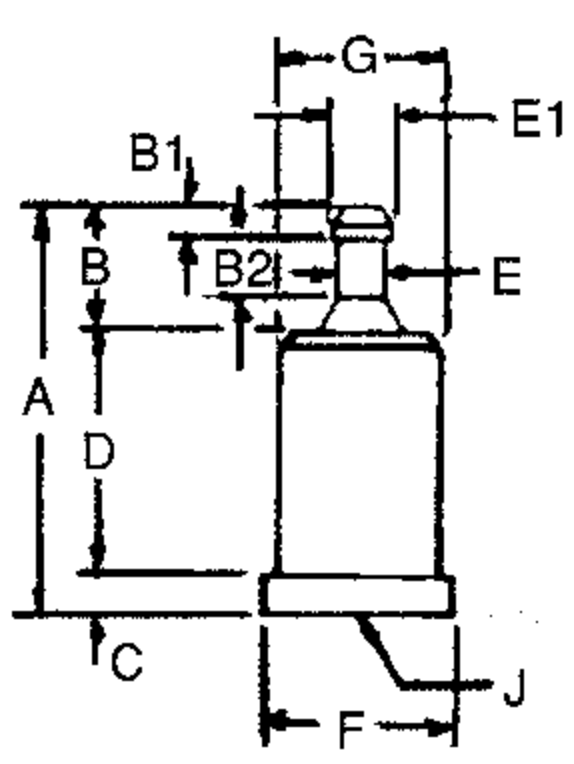

Fig 17

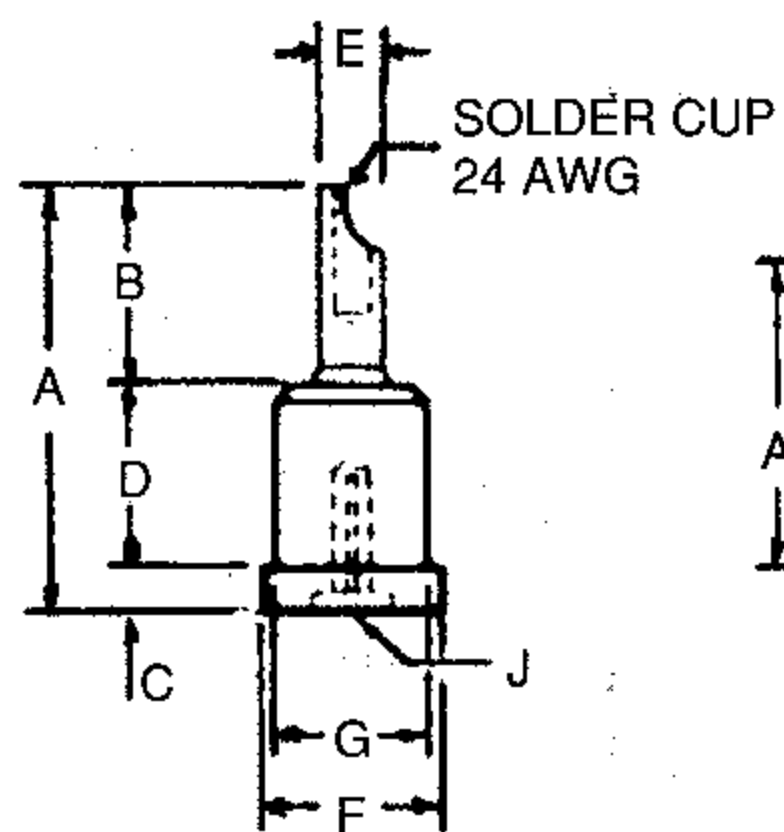

Fig 18

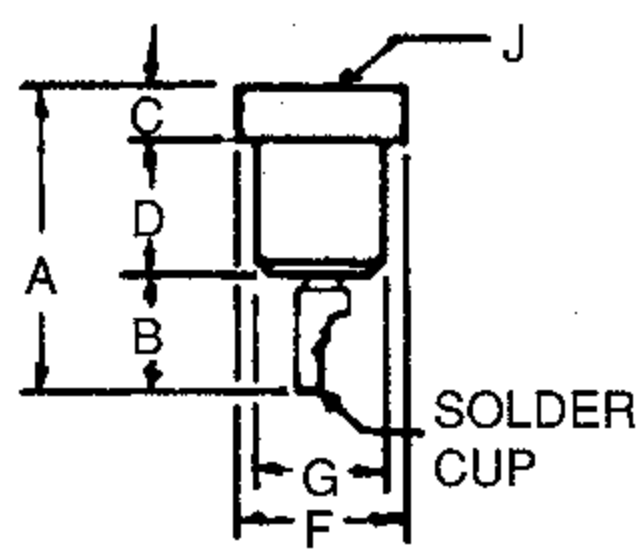

Fig 19

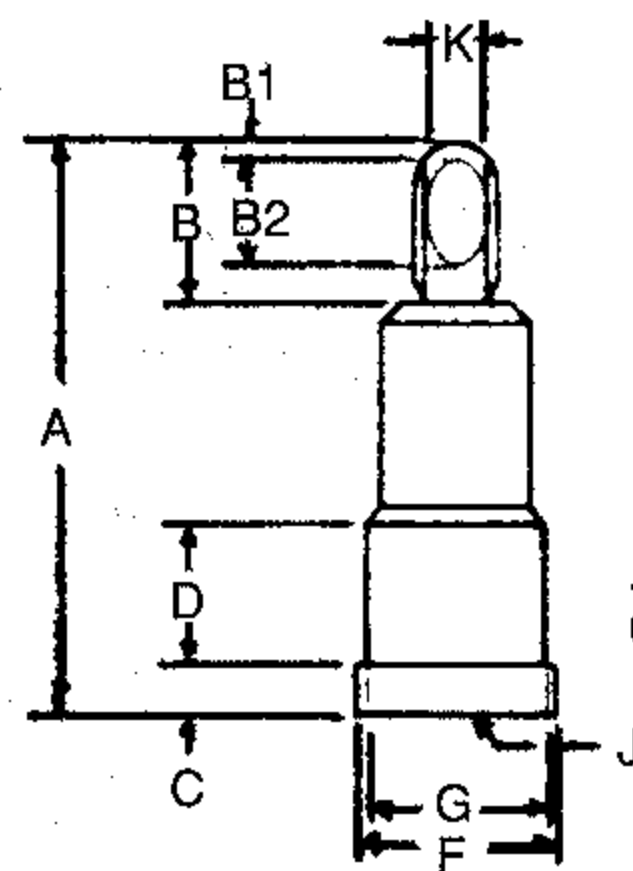

Fig 20

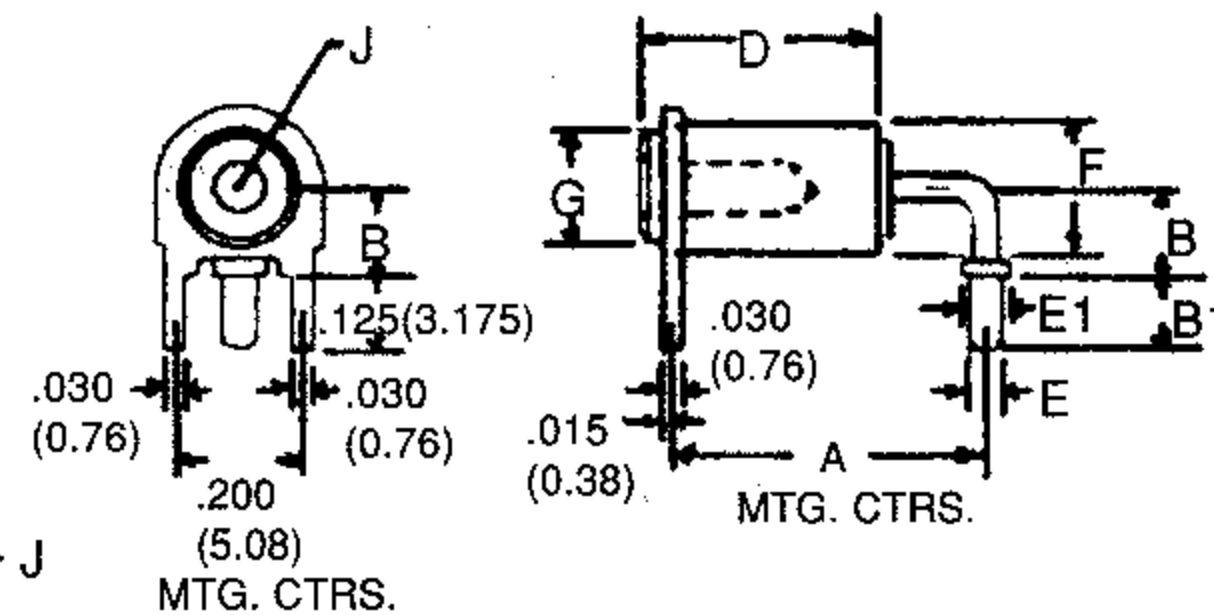

Fig 21

Fig	Part No.	Tool No.	Approx Capacitance mmf	V RMS 50Hz		A	B	B1	B2	C	D	E Dia	E1 Dia	F Dia	G * Dia	J Probe Dia	J1 Probe Lgth	K
				Nominal Rating	Flashover Sea Level													
17	016-2000-040209	S2	0.60	1000	3000	.437	.120	.037	.053	.046	.271	.054	.074	.218	.185	.080	.195	
17	016-2008-040209	S5	0.35	1000	3000	11.1	3.0	0.9	1.3	1.2	6.9	1.4	1.9	5.5	4.70	2.03	5.0	
						.345	.120	.023	.077	.046	.179	.040	.060	.172	.148	.040	.140	
18	016-6001-040209	S17	0.45	1000	3000	8.8	3.0	0.6	2.0	1.2	4.5	1.0	1.5	4.4	3.76	1.02	3.6	
						.408	.187			.046	.175	.060		.172	.148	.040	.135	
21	026-4005-040209		0.50	1200	3500	10.4	4.7			1.2	4.4	1.5		4.4	3.76	1.02	3.4	
						.400	.140	.125			.378	.050	.080	.218	.187	.080	.250	
19	016-6600-040209	S17	0.50	1000	3000	10.2	3.6	3.2			9.6	1.3	2.0	5.5	4.80	2.03	6.4	
						.359	.140			.065	.154			.187	.148	.040	.125	
20	016-8010-040209	S38	0.75	1000	3000	9.1	3.6			1.7	3.9			4.7	3.76	1.02	3.2	
						.637	.171	.028	.116	.050	.175			.218	.185	.080	.312	.055
						16.2	4.3	0.7	2.9	1.3	4.4			5.5	4.70	2.03	7.9	1.4

* +.002(0.05) -.000(0.00)

PROBES

Press-Fit Terminals

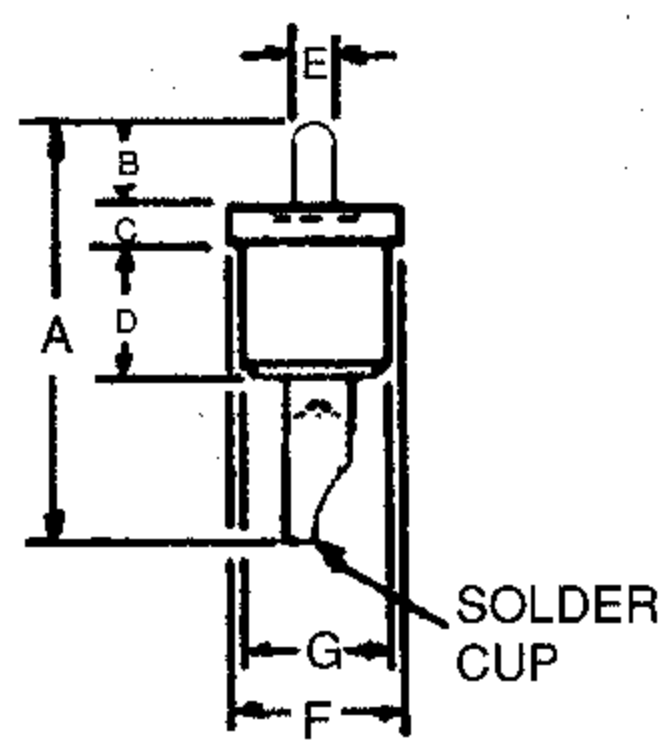

Fig 22

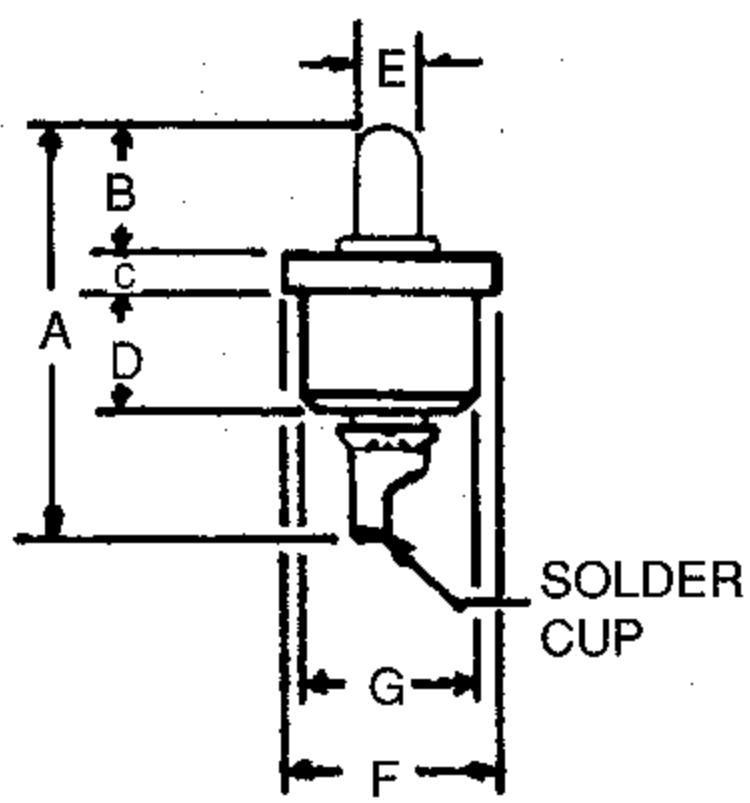

Fig 23

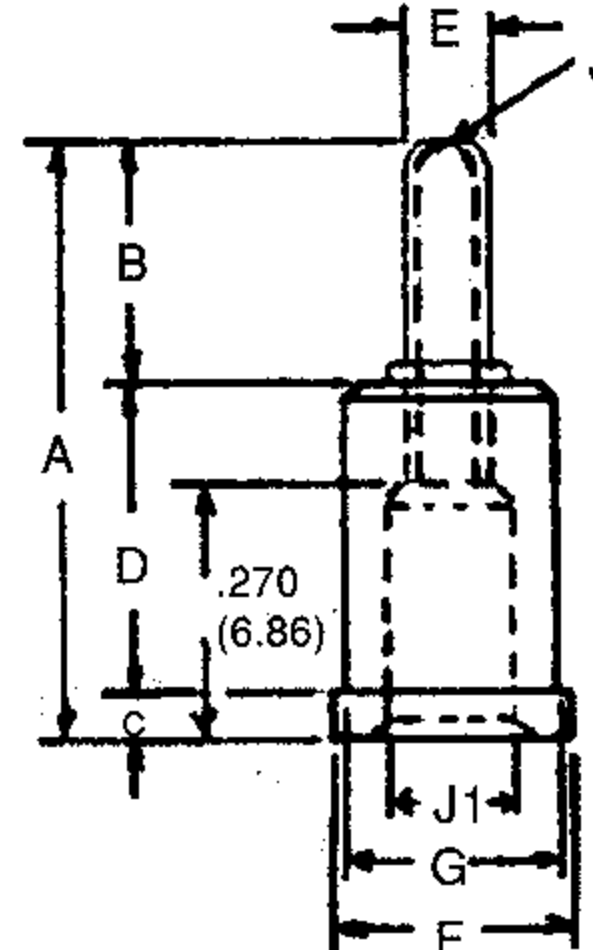

Fig 24

Fig	Part No.	Tool No.	Approx Capacitance mmf	V RMS 50Hz		A	B	C	D	E Dia	F Dia	G * Dia	J Dia	J1 Dia
				Nominal Rating	Flashover Sea Level									
22	011-4000-040209	B8-14	0.70	1000	3000	.538	.130	.046	.175	.040	.172	.148		
23	021-4006-040209	B-22X1	0.20	3400	7800	13.7	3.3	1.2	4.4	1.02	4.4	3.76		
						.645	.270	.050	.325	.080	.250	.218	.062	.128
24	011-4600-040209	B-13-3	0.55	1000	3000	16.4	6.9	1.3	8.3	2.03	6.4	5.54	1.6	3.3
						.407	.125	.065	.090	.040	.187	.148		
						10.3	3.2	1.7	2.3	1.02	4.7	3.76		

* +.002(0.05) -.000(0.00)

§ Floating Contact