

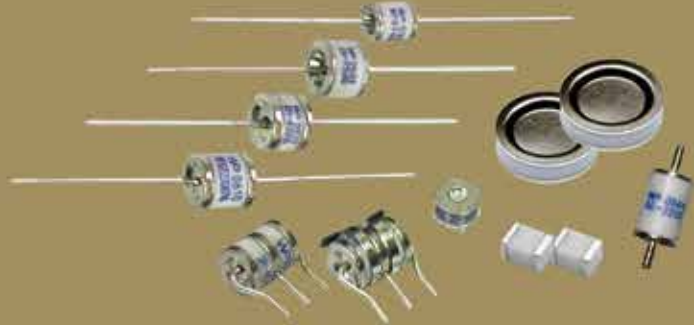

**WORLD PRODUCTS INC.**

# GAS DISCHARGE TUBES



**WORLD PRODUCTS INC.** || 19654 Eighth Street East || P.O. Box 517 || Sonoma, CA 95476  
Phone: (707) 996.5201 || FAX: (707) 996.3380 || [www.worldproducts.com](http://www.worldproducts.com) || [sales@worldproducts.com](mailto:sales@worldproducts.com)  
©2013 World Products Inc.



**THIS PAGE INTENTIONALLY LEFT BLANK.**

## Table of Contents

General Characteristics . . . . .	2
Temperature Rating . . . . .	2
100% Inspection . . . . .	2
RoHS Compliance . . . . .	2
Solderability . . . . .	2
Terms and Definitions . . . . .	2
Part Marking . . . . .	3
<b>2 Electrode Series . . . . .</b>	<b>4</b>
Part Numbering System . . . . .	4
2 Electrode Mini Series (2RM) . . . . .	5
2 Electrode Standard Series (2R) . . . . .	6
2 Electrode High Voltage Series (2R) . . . . .	7
2 Electrode High Current Series (2N) . . . . .	8
2 Electrode Switching Series (2T) . . . . .	9
2 Electrode Extremely High Current Series (20B) . . . . .	10
2 Electrode Standard, High Current, Ultra High Current & Screw Lead Series (AE) . . . . .	11
<b>3 Electrode Series . . . . .</b>	<b>12</b>
Part Numbering System . . . . .	12
3 Electrode Ultra Mini Series (3RSM) . . . . .	13
3 Electrode Symmetrical Series (3RSSM) . . . . .	15
3 Electrode Mini Series (3RM) . . . . .	17
3 Electrode Standard Series (3R) . . . . .	18
<b>2 &amp; 3 Electrode Surface Mount Series . . . . .</b>	<b>20</b>
Part Numbering System . . . . .	20
2 Electrode Surface Mount Mini Series (2SM) . . . . .	21
2 Electrode Surface Mount Mini Square Series (2SS) . . . . .	22
2 Electrode Surface Mount Standard Series (2S) . . . . .	23
2 Electrode Surface Mount Standard Low Profile Series (2SR) . . . . .	24
2 Electrode Surface Mount Chip Series (3216) . . . . .	25
2 Electrode Surface Mount Chip Series (4532) . . . . .	26
3 Electrode Surface Mount Mini Series (3SM) . . . . .	27
3 Electrode Surface Mount Symmetrical Series (3SSM) . . . . .	28
Packaging . . . . .	29
Applications . . . . .	32

## General Characteristics

### Features

- UL Recognition.
- CUL Recognition (specific types).
- Compliance to MIL STD 202G, method 208H and 106.
- Can be used to meet the requirements of GR-1361 and ITU K.12.
- AQL based on MIL STD 1916
- RoHs Compliant and Halogen Free.

### Temperature Rating

Storage -40°C to +150°C  
Operate -40°C to +90°C

### 100% Inspection

- DC Breakdown, insulation resistance, physical dimensions, lead/weld strength and appearance.
- All other gas tube characteristics are checked using the appropriate sampling procedures.
- ISO 9001 Certified.
- Gas Tubes have no radioactive content.

### RoHS Compliance

WPGT Series Gas Discharge Tubes purchased from World Products, LLC comply to a maximum concentration value of 0.1% by weight in homogeneous materials for lead (Pb), mercury, hexavalent chromium, polybrominated biphenyls (PBB) and polybrominated diphenyl ethers (PBDE) and of 0.01% weight in homogeneous materials for cadmium and are in compliance with Directive 2002/95/EC of the European Parliament and of the Council of 27 January 2003 on the restriction of the use of certain hazardous substances in electrical and electronic equipment (RoHS Directive). Fail safe types with date code of 10/05 or after comply to RoHS standards stated above.

## Solderability

- All thru-hole types comply with MIL STD 202G, Method 208H.
- For surface mount types see below (J-STD-020C).

Lead-Free Reflow Profile Recommendation (IPC/JEDEC J-STD-020C)	
Reflow Parameter	Lead-Free Assembly
Minimum preheat temperature (TsMIN)	150°C
Maximum preheat temperature (TsMAX)	200°C
Preheat Time	60-180 seconds
TsMAX to TL ramp-up rate	3°C/second maximum
Time above temperature TL (tL)	217°C 60-120 seconds
Peak Temperature (TP)	245°C ~260°C (recommended 250°C)
Time 25°C to TP	6 minute maximum
Time within 5° of Peak TP	10-20 seconds
Ramp-down rate	4°C/second maximum

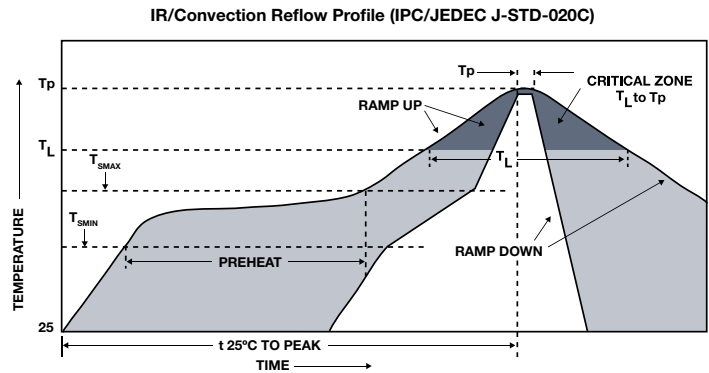

## Terms and Definitions

<b>DC Breakdown Voltage</b>	The voltage measured at a rise time of 100v/s.	
<b>Maximum Impulse Breakdown Voltage</b>	The maximum breakdown voltage at rise times of 100v/us and 1000v/us for 99% of measured values.	
<b>Maximum Impulse Discharge Current</b>	The maximum current applying a waveform of 8/20us that can be applied across the terminals of the gas tube without causing the gas tube to change more than -20%, +30% from its initial measured DC breakdown voltage. Dwell time between pulses is 3 minutes.	
<b>Alternating Discharge Current</b>	Rated RMS value of AC current at 50Hz, 1 sec. 10 times. Intervals: 3min. DC breakdown voltage may not change more than ±25% from its initial measured DC breakdown voltage. IR > 10 <sup>8</sup> ohms (-20%, +30% for 70 - 90V).	
<b>Impulse Life</b>	The minimum number of impulses of a specified waveform and peak current which a gas tube will conduct without causing the gas tube to change more than ±25% from its initial measured DC breakdown voltage. Dwell time between pulses is 1-2 minutes.	
<b>DC Holdover Voltage</b>	The maximum DC voltage across the two terminals of the gas tube under which it may be expected to return to the high impedance state after the gas tube breakdown.	
<b>Insulation Resistance</b>	The resistance of the gas tube shall be measured each terminal to each other terminal.	
	DC Breakdown Voltage	Measuring Voltage
	70-150V	50V
	151-400V	100V
<b>Capacitance</b>	470-1000V	250V
	1001-2000V	500V
	2001-6000V	1000V
	The capacitance of a gas tube shall be measured each terminal to each other terminal. Test frequency: 1MHz. In measurements involving 3-electrode gas tubes, the terminal not being tested shall be connected to a ground plane.	

General Characteristics (continued)

Part Marking

**2 Electrode Series**

Explanation of Example:

- World Products Inc. Logo
- 4 Digit EIA Date Code
- /C = Low Capacitance (Only applicable for 2R & 2N, 70V - 145V)
- /S Denotes WPGT-2R600S or WPGT-2R800S
- 2RM = 2 Electrode Mini (not pictured)
- 2R = 2 Electrode Standard
- 2N = 2 Electrode High Current
- WPGT = 2 Electrode High Voltage
- 2T = 2 Electrode Switching (not pictured)
- 145 = DC Breakdown Voltage
- 3000 = DC Breakdown Voltage
- UL recognition

**2 Electrode Surface Mount Series**

Explanation of Example:

- 145 = DC Breakdown Voltage
- 4 Digit EIA Date Code
- 2SM — UL recognition
- 2SS
- 2S and 2SR

**2 Electrode Surface Mount Chip 3216 and 4532 Series**

350 = DC Breakdown Voltage

**2 Electrode Extremely High Current 20B Series**

4 Digit EIA Date Code

350 = DC Breakdown Voltage

UL Recognition

Part Number Series

**3 Electrode Surface Mount (3SM & 3SSM) Series**

Explanation of Example:

- World Products Inc. Logo
- 4 Digit EIA Date Code
- 350 = DC Breakdown Voltage
- UL recognition
- This applies for 3SSM series only.

2 Electrode AE Series

**High Voltage Screw Lead Type**

Explanation of Example:

- High Voltage Screw Lead Type
- World Products Inc. Logo
- 4 Digit EIA Date Code
- 2000 = DC Breakdown Voltage
- Series Type

**No Lead Standard Type AE Series**

Explanation of Example:

- World Products Inc. Logo
- 4 Digit EIA Date Code
- 600 = DC Breakdown Voltage
- Series Type

**3 Electrode Series**

Explanation of Example:

- World Products Inc. Logo
- 4 Digit EIA Date Code
- 3R = Standard Series
- 3RM = Mini Series
- 3RSM = Ultra Mini Series
- 3RSSM = Symmetrical Series
- 145 = DC Breakdown Voltage
- UL recognition

**No Lead Ultra High Current Type AE Series**

Explanation of Example:

- World Products Inc. Logo
- 4 Digit EIA Date Code
- 600 = DC Breakdown Voltage
- Series Type

**No Lead High Current Type AE Series**

Explanation of Example:

- World Products Inc. Logo
- 4 Digit EIA Date Code
- 600 = DC Breakdown Voltage
- Series Type

## 2 Electrode Series

### Part Numbering System

Example part number:

**WPGT** - **2R** **800** **B** **8** **L** **C** **TA**  
 (1) (2) (3) (4) (5) (6) (7) (8)

**(1) World Products Gas Discharge Tubes**

**(2) Series Code**

- 2RM** = 2 Electrode Mini Series
- 2R** = 2 Electrode Standard Series and High Voltage Series
- 2N** = 2 Electrode High Current Series
- 2T** = 2 Electrode Switching Type
- 20B** = 2 Electrode Extremely High Current Series
- AE** = 2 Electrode Standard, High Current, Ultra High Current & Screw Lead Series)

**(3) DC Breakdown Voltage**

**(Please reference specification to determine available voltage options for each series.)**

- |                    |                     |
|--------------------|---------------------|
| <b>70</b> = 70V    | <b>600</b> = 600V   |
| <b>75</b> = 75V    | <b>700</b> = 700V   |
| <b>90</b> = 90V    | <b>800</b> = 800V   |
| <b>120</b> = 120V  | <b>1000</b> = 1000V |
| <b>130</b> = 130V  | <b>1200</b> = 1200V |
| <b>145</b> = 145V  | <b>1400</b> = 1400V |
| <b>150</b> = 150V  | <b>1600</b> = 1600V |
| <b>180</b> = 180V  | <b>2000</b> = 2000V |
| <b>230</b> = 230V  | <b>2500</b> = 2500V |
| <b>250</b> = 250V  | <b>2700</b> = 2700V |
| <b>300</b> = 300V  | <b>3000</b> = 3000V |
| <b>350</b> = 350V  | <b>3500</b> = 3500V |
| <b>400</b> = 400V  | <b>3600</b> = 3600V |
| <b>420</b> = 420V  | <b>4000</b> = 4000V |
| <b>470</b> = 470V  | <b>4500</b> = 4500V |
| <b>600S</b> = 600V | <b>5000</b> = 5000V |
| <b>800S</b> = 800V | <b>6000</b> = 6000V |

**(4) Diameter ("D" Dimension)**

- A** = 5.5mm - 2RM Series Only
- B** = 8mm
- D** = 11.8mm for AE Series
- Nil** = For 20B Series

**(7) Low Capacitance**

- (Only applicable for 2R & 2N, 70V – 145V)
- C** = Low capacitance of 0.8pf

**(5) Length ("T" Dimension)**

- 6** = 6mm
- 8** = 8mm
- 10** = 10mm - High Voltage Series Only
- 12** = 12mm
- 17** = 17mm
- Nil** = For 20B Series

**(8) Taping Specifications**

- TA** = Taped (Ammo Box)
- TR** = Tape & Reel

**(6) Lead Type**

- B** = No Leads
- Nil** = No Leads for 20B Series
- L** = Axial lead (0.8mm lead diameter)
- L1** = Axial lead (1.0mm lead diameter)
- A1** = Radial lead (0.8mm lead diameter)
- B1** = Radial lead (1.0mm lead diameter)
- C1** = Radial lead Clip-in style (1.0mm lead diameter)
- D1** = Radial Lead Clip-in style (0.8mm lead diameter)
- D4** = Radial Lead for 20B Series
- D5** = Tab Lead for 20B Series
- S** = Screw Lead Type for AE Series

## 2 Electrode Mini Series (2RM) Specifications

Base Part Number	DC Breakdown Voltage (V)		Maximum Impulse Breakdown Voltage (V)		Maximum Impulse Discharge Current (8/20 $\mu$ s) (KA)		Alternating Discharge Current (A)		Impulse Life (10/1000 $\mu$ s) (100A)	DC Holdover Voltage (V)	Minimum Insulation Resistance (G $\Omega$ )	Maximum Capacitance (pf)
	100V/s	100V/ $\mu$ s	1000V/ $\mu$ s	1 time	10 times (5 times each polarity)	50Hz, 1 sec	Single 9 cycles	times	<150ms	*	1MHz	
WPGT-2RM70	70 $\pm$ 20%	700	800	10	5	5	20	300	52	1	1	
WPGT-2RM75	75 $\pm$ 20%	700	800	10	5	5	20	300	52	1	1	
WPGT-2RM90	90 $\pm$ 20%	600	700	10	5	5	20	300	52	1	1	
WPGT-2RM120	120 $\pm$ 15%	600	700	10	5	5	20	300	52	1	1	
WPGT-2RM130	130 $\pm$ 15%	600	700	10	5	5	20	300	52	1	1	
WPGT-2RM145	145 $\pm$ 15%	600	700	10	5	5	20	300	52	1	1	
WPGT-2RM150	150 $\pm$ 15%	600	700	10	5	5	20	300	52	1	1	
WPGT-2RM180	180 $\pm$ 15%	600	700	10	5	5	20	300	80	1	1	
WPGT-2RM230	230 $\pm$ 15%	600	700	10	5	5	20	300	80	1	1	
WPGT-2RM250	250 $\pm$ 15%	600	700	10	5	5	20	300	80	1	1	
WPGT-2RM300	300 $\pm$ 15%	700	900	10	5	5	20	300	150	1	1	
WPGT-2RM350	350 $\pm$ 15%	700	900	10	5	5	20	300	150	1	1	
WPGT-2RM400	400 $\pm$ 15%	800	1000	10	5	5	20	300	150	1	1	
WPGT-2RM470	470 $\pm$ 15%	1000	1200	10	5	5	20	300	150	1	1	
WPGT-2RM600	600 $\pm$ 20%	1300	1500	5	2.5	2.5	5	300	150	1	1	
WPGT-2RM800	800 $\pm$ 20%	1500	1700	5	2.5	2.5	5	300	150	1	1	
WPGT-2RM1000	1000 $\pm$ 20%	1600	1800	3	1.5	2	4	300	150	1	1	
WPGT-2RM1200	1200 $\pm$ 20%	1800	2000							1	1	
WPGT-2RM1400	1400 $\pm$ 20%	2200	2400							1	1	
WPGT-2RM1600	1600 $\pm$ 20%	2400	2600							1	1	
WPGT-2RM2000	2000 $\pm$ 20%	2800	3000							1	1	
WPGT-2RM2500	2500 $\pm$ 20%	3300	3500							1	1	
WPGT-2RM3000	3000 $\pm$ 20%	3800	4000							1	1	
WPGT-2RM3500	3500 $\pm$ 20%	4300	4500							1	1	
WPGT-2RM3600	3600 $\pm$ 20%	4400	4600							1	1	

UL497B Recognized, File #E135015 (through WPGT-2RM800).  
 UL1449 and C-UL 3rd Edition Recognized, File# E321567  
 (WPGT-2RM1000 – WPGT-2RM3600)

### Dimensions

Unit: mm

Item	Dimensions
D	5.5 $\pm$ 0.3
T	6.0 $\pm$ 0.3
d	0.8 or 1.0 $\pm$ 0.05
L	24 Min.

*DC Breakdown Voltage	DC Measuring Voltage
70-90V	50V
120-400V	100V
470-800V	250V
1000-2000V	500V
2500-4000V	1000V

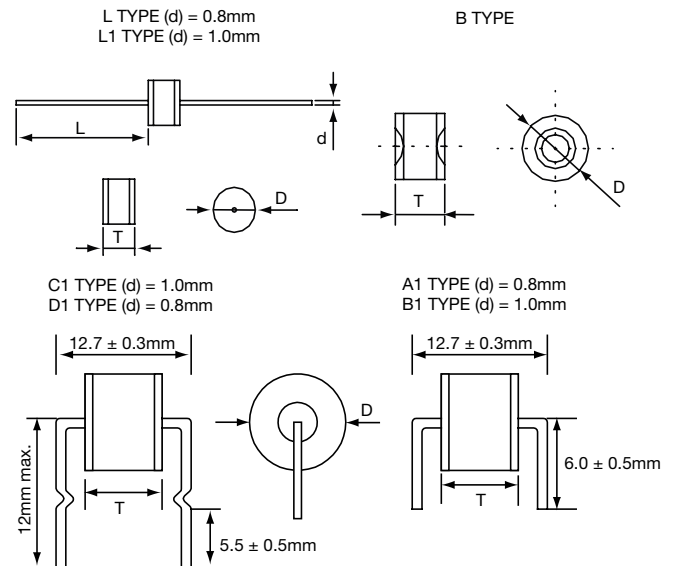

## 2 Electrode Standard Series (2R)

### Specifications

Base Part Number	DC Breakdown Voltage (V)	Maximum Impulse Breakdown Voltage (V)		Maximum Impulse Discharge Current (8/20 $\mu$ s) (KA)		Alternating Discharge Current (A)		Impulse Life (10/1000 $\mu$ s) (100A)	DC Holdover Voltage (V)	Minimum Insulation Resistance (G $\Omega$ )	Maximum Capacitance (pf)
	100V/s	100V/ $\mu$ s	1000V/ $\mu$ s	1 time	10 times (5 times each polarity)	50Hz, 1 sec	Single 9 cycles	times	<150ms	*	1MHz
WPGT-2R70	70 $\pm$ 20%	500	600	15	10	10	65	500	52	10	1.5**
WPGT-2R75	75 $\pm$ 20%	500	600	15	10	10	65	500	52	10	1.5**
WPGT-2R90	90 $\pm$ 20%	500	600	15	10	10	65	500	52	10	1.5**
WPGT-2R120	120 $\pm$ 15%	500	700	15	10	10	65	500	52	10	1.5**
WPGT-2R130	130 $\pm$ 15%	500	700	15	10	10	65	500	52	10	1.5**
WPGT-2R145	145 $\pm$ 15%	500	700	15	10	10	65	500	52	10	1.5**
WPGT-2R180	180 $\pm$ 15%	500	700	15	10	10	65	500	80	10	1.5
WPGT-2R230	230 $\pm$ 15%	500	700	15	10	10	65	500	80	10	1.5
WPGT-2R250	250 $\pm$ 15%	500	700	15	10	10	65	500	80	10	1.5
WPGT-2R300	300 $\pm$ 15%	700	900	15	10	10	65	500	150	10	1.5
WPGT-2R350	350 $\pm$ 15%	700	900	15	10	10	65	500	150	10	1.5
WPGT-2R400	400 $\pm$ 15%	800	1000	15	10	10	65	500	150	10	1.5
WPGT-2R470	470 $\pm$ 15%	1000	1200	15	10	10	65	500	150	10	1.5
WPGT-2R600S	600 $\pm$ 20%	1100	1400	10	5	10	65	300	150	10	1.5
WPGT-2R800S	800 $\pm$ 20%	1300	1700	10	5	10	65	300	150	10	1.5

#### UL497B Recognized, File #E135015

\*DC Breakdown Voltage    DC Measuring Voltage  
 70-90V                      50V  
 120-400V                  100V  
 470-800V                  250V

\*\*May be offered with 0.8pf capacitance rating.  
 See part numbering system for special coding.

### Dimensions

Unit: mm

Item	Dimensions
D	8.0 $\pm$ 0.3
T	6.0 $\pm$ 0.3
d	0.8 or 1.0 $\pm$ 0.05
L	24 Min.

**L TYPE (d) = 0.8mm**  
**L1 TYPE (d) = 1.0mm**

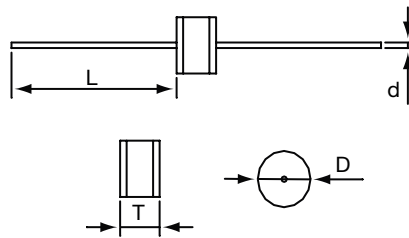

**B TYPE**

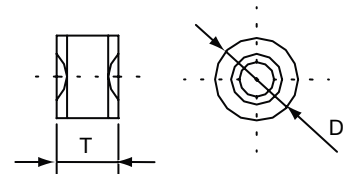

**C1 TYPE (d) = 1.0mm**  
**D1 TYPE (d) = 0.8mm**

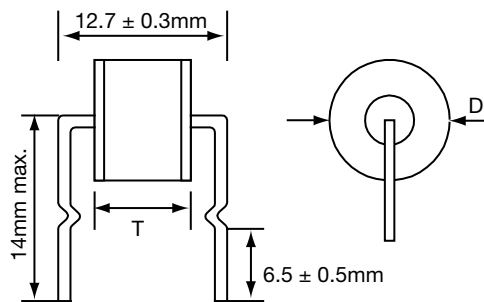

**A1 TYPE (d) = 0.8mm**  
**B1 TYPE (d) = 1.0mm**

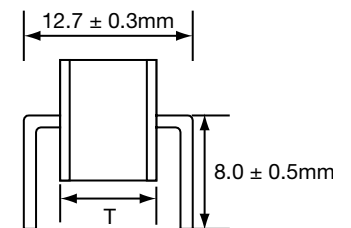



## 2 Electrode High Voltage Series (2R)

### Specifications

Base Part Number	DC Breakdown Voltage (V)	Maximum Impulse Breakdown Voltage (V)		Maximum Impulse Discharge Current (8/20 $\mu$ s) (KA)		Alternating Discharge Current (A)		Impulse Life (10/1000 $\mu$ s) (100A)	Minimum Insulation Resistance (G $\Omega$ )	Maximum Capacitance (pf)
	100V/s	100V/ $\mu$ s	1000V/ $\mu$ s	1 time	10 times (5 times each polarity)	50Hz, 1 sec	Single 9 cycles	times	*	1MHz
WPGT-2R600	600 $\pm$ 15%	1000	1100	10	5	10	65	500	10	1.5
WPGT-2R800	800 $\pm$ 15%	1100	1200	10	5	10	65	500	10	1.5
WPGT-2R1000	1000 $\pm$ 20%	1300	1400	10	5	10	65	300	10	1.0
WPGT-2R1400	1400 $\pm$ 20%	2100	2200	5	2.5	2.5	5	100	10	1.0
WPGT-2R1600	1600 $\pm$ 20%	2300	2400	5	2.5	2.5	5	100	10	1.0
WPGT-2R2000	2000 $\pm$ 20%	2700	2800	5	2.5	2.5	5	100	10	1.0
WPGT-2R2500	2500 $\pm$ 20%	3500	3600	5	2.5	2.5	5	100	10	1.0
WPGT-2R2700	2340-2970	3600	$\leq$ 3800	5	3***	2.5	5	300**	10	1.0
WPGT-2R3000	3000 $\pm$ 20%	4100	4200	5	3	2.5	5	300**	10	1.0
WPGT-2R3500	3500 $\pm$ 20%	4900	5000	5	3	2.5	5	100	10	1.0
WPGT-2R4000	4000 $\pm$ 20%	5300	5500	5	3	2.5	5	100	10	1.0
WPGT-2R4500	4500 $\pm$ 20%	5800	6000	5	3	2.5	5	100	10	1.0
WPGT-2R5000	5000 $\pm$ 20%	6000	6400	5	3	2.5	5	100	10	1.0
WPGT-2R6000	6000 $\pm$ 20%	7000	7800	5	3	2.5	5	100	10	1.0

**UL 1449 and C-UL 3rd Edition Recognized, File #E321567.** WPGT-2R2700 is additionally C-UL & UL 1414 Recognized, File #E71602, Complies to VDE Gap requirements and MIL-STD-202, Method 106 (Moisture resistance.) \*Gas Discharge Tubes may not be recognized to UL1414 from December 25, 2013.

\*DC Breakdown Voltage      DC Measuring Voltage  
 600-1000V                      250V  
 1400-2000V                    500V  
 2500-6000V                    1000V

\*\*Measured with an 8/20 $\mu$ s waveform, 100A.  
 \*\*\*For WPGT-2R2700 rating is 3KA (10 times each polarity).  
 DC Breakdown voltage is measured at 5kV/s.

### Dimensions

Unit: mm

Item	Dimensions
D	8.0 $\pm$ 0.3
T*	8.0 +0.6, -0.1
d	0.8 or 1.0 $\pm$ 0.05
L	24 Min.

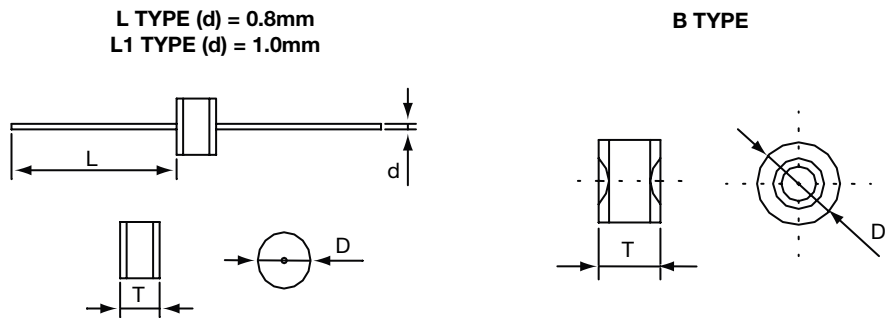

**C1 TYPE (d) = 1.0mm**  
**D1 TYPE (d) = 0.8mm**

**A1 TYPE (d) = 0.8mm**  
**B1 TYPE (d) = 1.0mm**

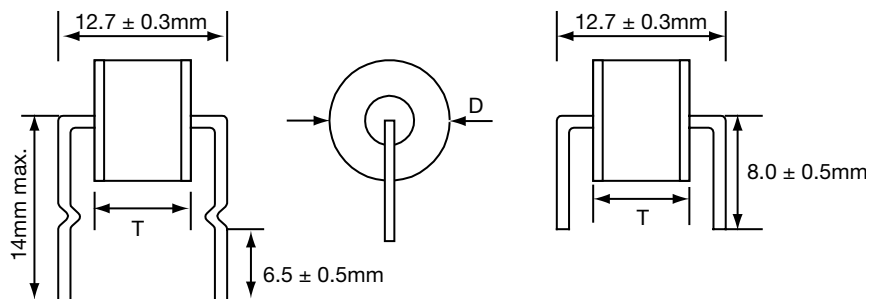

\*T Dimension for WPGT-2R5000 and WPGT-2R6000 is 10 +0.6, -0.1.

## 2 Electrode High Current Series (2N)

### Specifications

Base Part Number	DC Breakdown Voltage (V)	Maximum Impulse Breakdown Voltage (V)		Maximum Impulse Discharge Current (8/20 $\mu$ s) (KA)		Alternating Discharge Current (A)		Impulse Life (10/1000 $\mu$ s) (100A)	DC Holdover Voltage (V)	Minimum Insulation Resistance (G $\Omega$ )	Maximum Capacitance (pf)
	100V/s	100V/ $\mu$ s	1000V/ $\mu$ s	1 time	10 times (5 times each polarity)	50Hz, 1 sec	Single 9 cycles	times	<150ms	*	1MHz
WPGT-2N70	70 $\pm$ 20%	500	600	20	15	20	65	500	52	10	1.5**
WPGT-2N75	75 $\pm$ 20%	500	600	20	15	20	65	500	52	10	1.5**
WPGT-2N90	90 $\pm$ 20%	500	600	20	15	20	65	500	52	10	1.5**
WPGT-2N120	120 $\pm$ 15%	500	700	20	15	20	65	500	52	10	1.5**
WPGT-2N130	130 $\pm$ 15%	500	700	20	15	20	65	500	52	10	1.5**
WPGT-2N145	145 $\pm$ 15%	500	700	20	15	20	65	500	52	10	1.5**
WPGT-2N180	180 $\pm$ 15%	500	700	20	15	20	65	500	80	10	1.5
WPGT-2N230	230 $\pm$ 15%	500	700	20	15	20	65	500	80	10	1.5
WPGT-2N250	250 $\pm$ 15%	500	700	20	15	20	65	500	80	10	1.5
WPGT-2N300	300 $\pm$ 15%	700	900	20	15	20	65	500	150	10	1.5
WPGT-2N350	350 $\pm$ 15%	700	900	20	15	20	65	500	150	10	1.5
WPGT-2N400	400 $\pm$ 15%	800	1000	20	15	20	65	500	150	10	1.5
WPGT-2N470	470 $\pm$ 15%	1000	1200	20	15	20	65	500	150	10	1.5
WPGT-2N600	600 $\pm$ 15%	1100	1300	20	15	20	65	500	150	10	1.5

**UL497B Recognized, File #E135015**

*DC Breakdown Voltage	DC Measuring Voltage
70-90V	50V
120-400V	100V
470V - 600V	250V

\*\*May be offered with 0.8pf capacitance rating. See part numbering system for special coding.

**L TYPE (d) = 0.8mm**  
**L1 TYPE (d) = 1.0mm**

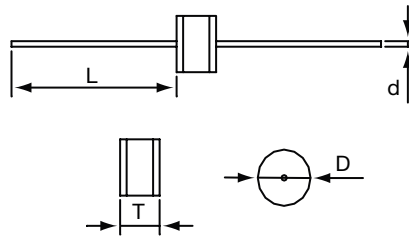

**B TYPE**

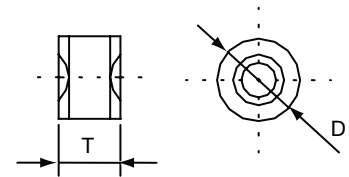

### Dimensions

Unit: mm

Item	Dimensions
D	8.0 $\pm$ 0.3
T	6.0 $\pm$ 0.3
d	0.8 or 1.0 $\pm$ 0.05
L	24 Min.

**C1 TYPE (d) = 1.0mm**  
**D1 TYPE (d) = 0.8mm**

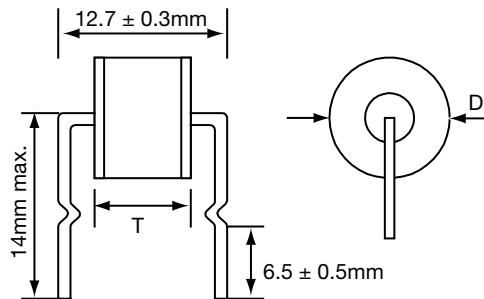

**A1 TYPE (d) = 0.8mm**  
**B1 TYPE (d) = 1.0mm**

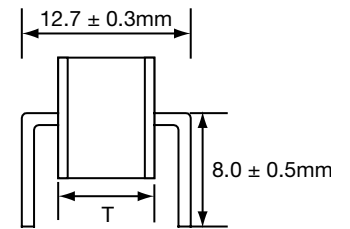

## 2 Electrode Switching Series (2T)

### Specifications

Base Part Number	DC Breakdown Voltage (V)	Maximum Ignition Frequency (HZ)	Switching Operations (times)	Minimum Insulation Resistance (GΩ)*	Operating Temperature °C	Maximum Capacitance 0.1Vrms 1MHZ (pf)
	100V/s					
WPGT-2T350	350 ± 10%	400	1 x 10 <sup>5</sup>	1	-45 ~ + 125	1
WPGT-2T400	400 ± 10%	400	1 x 10 <sup>5</sup>	1	-45 ~ + 125	1
WPGT-2T470	470 ± 10%	400	1 x 10 <sup>5</sup>	1	-45 ~ + 125	1
WPGT-2T600	600 ± 10%	400	1 x 10 <sup>5</sup>	1	-45 ~ + 125	1
WPGT-2T800	800 ± 10%	400	1 x 10 <sup>5</sup>	1	-45 ~ + 125	1
WPGT-2T1000	1000 ± 10%	400	1 x 10 <sup>5</sup>	1	-45 ~ + 125	1

**UL497B Recognized, File #E135015** (With the exception of WPGT-2T800 and WPGT-2T1000.) **UL1449 and CUL 3rd Edition recognized, File #E321567** for **WPGT-2T800 and WPGT-2T1000.**

\*DC Breakdown Voltage      DC Measuring Voltage  
 350-400V                      100V  
 470-1000V                    250V

### Dimensions

Unit: mm

Item	Dimensions
D	8.0 ± 0.3
T	6.0 ± 0.3
d	0.8 ± 0.05
L	25 Max.

**L Type (d) = 0.8mm**

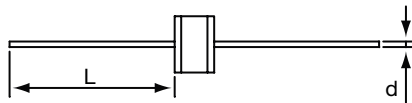

**B Type**

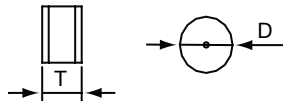

### Basic Application Circuit

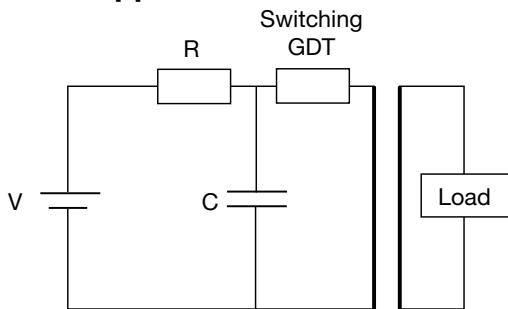

## 2 Electrode Extremely High Current Series (20B)

### Specifications

Base Part Number	DC Breakdown Voltage (V)		Maximum Impulse Breakdown Voltage (V)		Maximum Impulse Discharge Current (8/20 $\mu$ s) (KA)		Alternating Discharge Current (A)		Impulse Life (10/1000 $\mu$ s) (300A)	Minimum Insulation Resistance (G $\Omega$ )	Maximum Capacitance (pf)
	100V/s	100V/ $\mu$ s	1000V/ $\mu$ s	1 time	10 times (5 times each polarity)	50Hz, 1 sec	Single 9 cycles	times	*	1MHz	
WPGT-20B150	150 $\pm$ 20%	600	700	60	40	40	80	300	1	5	
WPGT-20B230	230 $\pm$ 20%	600	700								
WPGT-20B300	300 $\pm$ 20%	600	700								
WPGT-20B350	350 $\pm$ 20%	700	800								
WPGT-20B400	400 $\pm$ 20%	750	850								
WPGT-20B420	420 $\pm$ 20%	750	850								
WPGT-20B470	470 $\pm$ 20%	800	900								
WPGT-20B600	600 $\pm$ 20%	900	1000								
WPGT-20B800	800 $\pm$ 20%	1100	1200	30	20	20	40				
WPGT-20B1000	1000 $\pm$ 20%	1400	1500								

**UL1449 and CUL 3rd Edition Recognized File #E321567.**

*DC Breakdown Voltage	DC Measuring Voltage
150-400V	100V
470-1000V	250V

### Dimensions

UNIT: mm

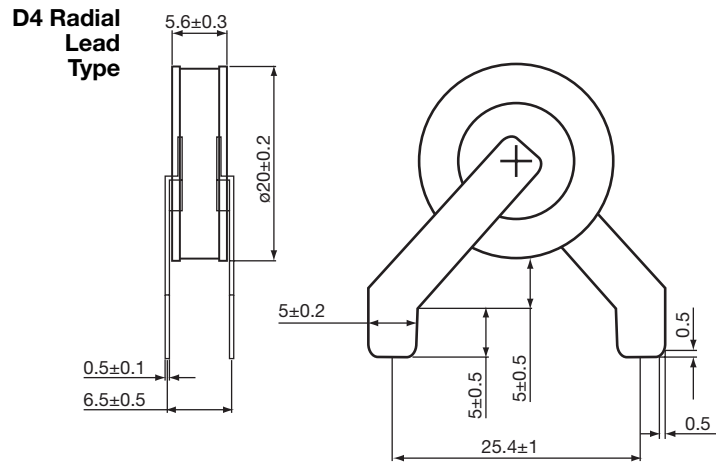
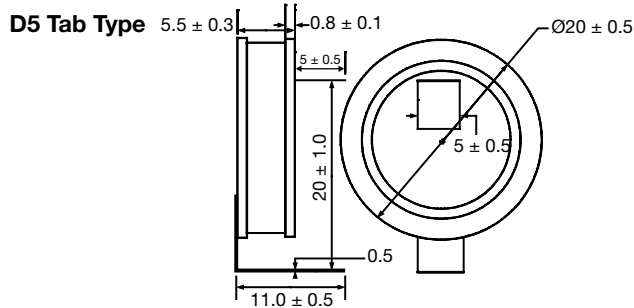
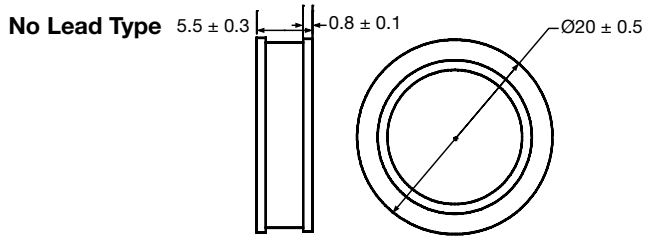

# GAS DISCHARGE TUBES

## 2 Electrode AE (Standard, High Current, Ultra High Current & Screw Lead ) Series Specifications

Base Part Number	DC Breakdown Voltage (V)	Maximum Impulse Breakdown Voltage (V)		Maximum Impulse Discharge Current (8/20 $\mu$ s) (KA)		Alternating Discharge Current (A)		Impulse Life (10/1000 $\mu$ s) (500A)	DC Holdover Voltage (V)	Minimum Insulation Resistance (G $\Omega$ )	Maximum Capacitance (pf)
	100V/s	100V/ $\mu$ s	1000V/ $\mu$ s	1 time	10 times (5 times each polarity)	50Hz, 1 sec	Single 9 cycles	times	<150ms	*	1MHz
<b>STANDARD</b>											
WPGT-AE230D8	230 $\pm$ 20%	600	700	40	20	20	120	400	135	10	5
WPGT-AE250D8	250 $\pm$ 20%	600	700	40	20	20	120	400	135	10	5
WPGT-AE300D8	300 $\pm$ 20%	700	800	40	20	20	120	400	150	10	5
WPGT-AE350D8	350 $\pm$ 20%	800	900	40	20	20	120	400	150	10	5
WPGT-AE420D8	420 $\pm$ 20%	900	1000	40	20	20	120	400	150	10	5
WPGT-AE470D8	470 $\pm$ 20%	900	1100	40	20	20	120	400	150	10	5
WPGT-AE600D8	600 $\pm$ 20%	1100	1300	40	20	20	120	400	150	10	5
WPGT-AE700D8	700 $\pm$ 20%	1200	1400	40	20	20	120	400	150	10	5
WPGT-AE800D8	800 $\pm$ 20%	1300	1500	40	20	20	120	400	150	10	5
<b>HIGH CURRENT</b>											
WPGT-AE230D12	230 $\pm$ 20%	600	700	60	40	40	200	400	135	10	5
WPGT-AE250D12	250 $\pm$ 20%	600	700	60	40	40	200	400	135	10	5
WPGT-AE300D12	300 $\pm$ 20%	700	800	60	40	40	200	400	150	10	5
WPGT-AE350D12	350 $\pm$ 20%	800	900	60	40	40	200	400	150	10	5
WPGT-AE420D12	420 $\pm$ 20%	900	1000	60	40	40	200	400	150	10	5
WPGT-AE470D12	470 $\pm$ 20%	900	1100	60	40	40	200	400	150	10	5
WPGT-AE600D12	600 $\pm$ 20%	1100	1300	60	40	40	200	400	150	10	5
WPGT-AE700D12	700 $\pm$ 20%	1200	1400	60	40	40	200	400	150	10	5
WPGT-AE800D12	800 $\pm$ 20%	1300	1500	60	40	40	200	400	150	10	5
<b>ULTRA HIGH CURRENT</b>											
WPGT-AE230D17	230 $\pm$ 20%	600	700	100	60	60	300	400	135	10	5
WPGT-AE250D17	250 $\pm$ 20%	600	700	100	60	60	300	400	135	10	5
WPGT-AE300D17	300 $\pm$ 20%	700	800	100	60	60	300	400	150	10	5
WPGT-AE350D17	350 $\pm$ 20%	800	900	100	60	60	300	400	150	10	5
WPGT-AE420D17	420 $\pm$ 20%	900	1000	100	60	60	300	400	150	10	5
WPGT-AE470D17	470 $\pm$ 20%	900	1100	100	60	60	300	400	150	10	5
WPGT-AE600D17	600 $\pm$ 20%	1100	1300	100	60	60	300	400	150	10	5
WPGT-AE700D17	700 $\pm$ 20%	1200	1400	100	60	60	300	400	150	10	5
WPGT-AE800D17	800 $\pm$ 20%	1300	1500	100	60	60	300	400	150	10	5
<b>SCREW LEAD</b>											
WPGT-AE1000D17	1000 $\pm$ 20%	1500	1700	25	20	20	120	400	150	10	2
WPGT-AE1200D17	1200 $\pm$ 20%	1800	2000	25	20	20	120	400	150	10	2
WPGT-AE1400D17	1400 $\pm$ 20%	2000	2200	25	20	20	120	400	150	10	2
WPGT-AE1600D17	1600 $\pm$ 20%	2300	2500	25	20	20	120	400	150	10	2
WPGT-AE2000D17	2000 $\pm$ 20%	2600	2700	25	20	20	120	400	150	10	2
WPGT-AE2200D17	2200 $\pm$ 20%	2700	2800	25	20	20	120	400	150	10	2
WPGT-AE4500D17	4500 $\pm$ 20%	6000	6500	10	5	20	120	400	150	10	2

**UL 1449 Recognized, File #E321567**

(Except WPGT-AE1000D17 and WPGT-AE4500D17)

<b>*DC Breakdown Voltage</b>	<b>DC Measuring Voltage</b>
70 - 90V	50V
120 - 400V	100V
470 - 800V	250V
1000 - 1999V	500V
2000 - 4500V	1000V

No Lead Standard Type AE Series

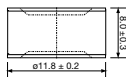

No Lead High Current Type AE Series

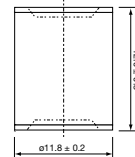

High Voltage Screw Lead Type

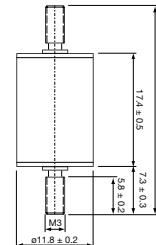

No Lead Ultra High Current Type AE Series

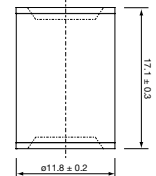

## 3 Electrode Series

### Part Numbering System

Example part number:

WPGT - 3R 200 C  
 (1) (2) (3) (4)

**(1) World Products Gas Discharge Tubes**

**(2) Series Code**

**3RSM** = 3 Electrode Ultra Mini Series  
**3RSSM** = 3 Electrode Symmetrical Series  
**3RM** = 3 Electrode Mini Series  
**3R** = 3 Electrode Standard Series

**(3) DC Breakdown Voltage**

**(Please reference specification to determine available voltage options for each series.)**

**75** = 75V  
**90** = 90V  
**120** = 120V  
**145** = 145V  
**150** = 150V  
**200** = 200V  
**230** = 230V  
**250** = 250V  
**260** = 260V  
**300** = 300V  
**350** = 350V  
**400** = 400V  
**420** = 420V  
**470** = 470V  
**550** = 550V  
**600** = 600V

**(4) Lead Type**

**B** = No Leads  
**CF** = (1.0mm lead diameter) with Fail Safe - 3R Series only  
**CF1** = (0.8mm lead diameter) with Fail Safe  
**C** = Radial lead (1.0mm lead diameter) - 3R Series only  
**C2** = Radial lead (0.8mm lead diameter) - 3R Series only  
**C3** = Radial lead with 3.8mm ± 0.5mm lead pitch (0.8mm lead diameter) 3RM, 3RSM and 3RSSM Series only  
**CF3** = Radial lead with 3.8mm ± 0.5mm lead pitch (0.8mm lead diameter) with Fail Safe - 3RSM and 3RSSM Series only  
**C4** = Radial lead with 4.0mm ± 0.5mm lead pitch (0.8mm lead diameter) 3RSM and 3RSSM Series only  
**CF4** = Radial lead with 4.0mm ± 0.5mm lead pitch (0.8mm lead diameter) with Fail Safe - 3RSM and 3RSSM Series only  
**G** = Axial lead (1.0mm lead diameter) - 3R Series only  
**G1** = Axial lead (0.8mm lead diameter)  
**G1F** = Axial lead (0.8mm lead diameter) with Fail Safe - 3RSM and 3RSSM Series only  
**H** = Radial lead with 4.4mm ± 0.3mm lead pitch (0.8mm lead diameter) 3RM Series only  
**HF** = Radial lead with 4.4mm ± 0.5mm lead pitch (0.8mm lead diameter) with Fail Safe - 3RSM and 3RSSM Series only

### 3 Electrode Ultra Mini Series (3RSM)

#### Specifications

Base Part Number	DC Breakdown Voltage (V)	Maximum Impulse Breakdown Voltage (V)		Maximum Impulse Discharge Current (8/20 $\mu$ s) (KA)		Alternating Discharge Current (A)		Impulse Life (10/1000 $\mu$ s) (200A)	DC Holdover Voltage (V)	Minimum Insulation Resistance (G $\Omega$ )	Maximum Capacitance (pf)
	100V/s NOTE 1	100V/ $\mu$ s NOTE 2	1000V/ $\mu$ s NOTE 2	1 time	10 times (5 times each polarity)	50Hz, 1 sec	Single 9 cycles	times	<150ms	*	1MHz
WPGT-3RSM75	75 $\pm$ 20%	400	600	20	10	5	30	300	52	1	2.0
WPGT-3RSM90	90 $\pm$ 20%	300	550	20	10	5	30	300	52	1	2.0
WPGT-3RSM120	120 $\pm$ 20%	350	550	20	10	5	30	300	80	1	2.0
WPGT-3RSM150	150 $\pm$ 20%	400	500	20	10	10	60	300	80	1	2.0
WPGT-3RSM200	200 $\pm$ 20%	500	600	20	10	10	60	300	135	1	2.0
WPGT-3RSM230	230 $\pm$ 20%	550	650	20	10	10	60	300	135	1	2.0
WPGT-3RSM250	250 $\pm$ 20%	550	650	20	10	10	60	300	135	1	2.0
WPGT-3RSM300	300 $\pm$ 20%	600	700	20	10	10	60	300	135	1	2.0
WPGT-3RSM350	350 $\pm$ 20%	650	750	20	10	10	60	300	135	1	2.0
WPGT-3RSM400	400 $\pm$ 20%	700	800	20	10	10	60	300	135	1	2.0
WPGT-3RSM420	420 $\pm$ 20%	700	800	20	10	10	60	300	135	1	2.0
WPGT-3RSM470	470 $\pm$ 20%	800	900	20	10	10	60	300	135	1	2.0
WPGT-3RSM600	600 $\pm$ 20%	900	1000	20	10	5	60	300	135	1	2.0

**UL 497B Recognized, File #E135015.**

*DC Breakdown Voltage	DC Measuring Voltage
75 - 120V	50V
150 - 400V	100V
420 - 600V	250V

**NOTE 1:** DC Breakdown Voltage @ 100V/s for L1/L2 to ground.

**NOTE 2:** Impulse Breakdown Voltage @ 100V/ $\mu$ s and 1000V/ $\mu$ s for L1/L2 to ground.

### 3 Electrode Ultra Mini Series (3RSM)

Dimensions in mm.

#### G1 TYPE

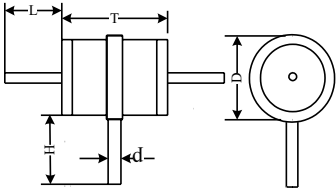

#### G1F TYPE

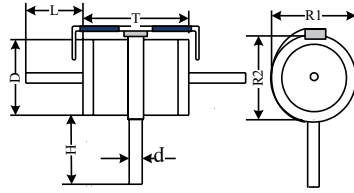

#### H TYPE(S) = 4.4 ± 0.5mm

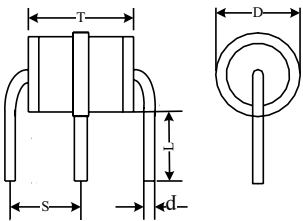

#### HF TYPE

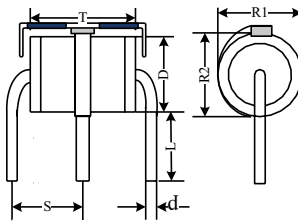

#### C3 TYPE(S) = 3.8 ± 0.5mm

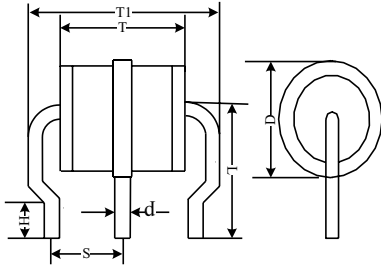

#### CF3 TYPE

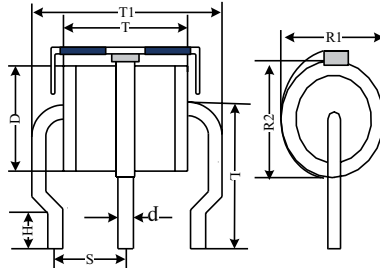

#### C4 TYPE(S) = 4.0 ± 0.5

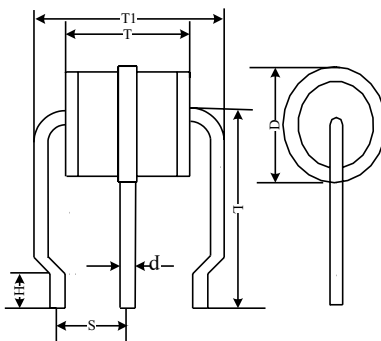

#### CF4 TYPE

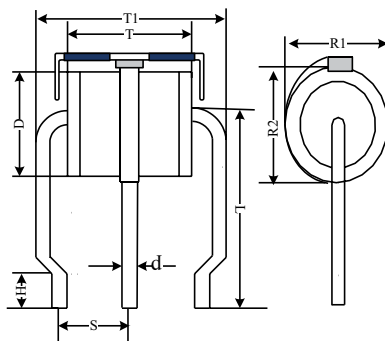

Item	Dimensions	
	Spec.	Tolerance
D	5.0	± 0.1
T	7.2	± 0.3
d	0.8	± 0.05
L	15.8	± 0.5
H	9.4	± 0.5
R1	5.8	Max.
R2	7.0	Max.

Item	Dimensions	
	Spec.	Tolerance
D	5.0	± 0.1
T	7.2	± 0.3
S	4.4	± 0.5
d	0.8	± 0.05
L	4.5	Min.
R1	5.8	Max.
R2	7.0	Max.

Item	Dimensions	
	Spec.	Tolerance
D	5.0	± 0.1
T	7.2	± 0.3
T1	12.0	Max.
L	12.0	Max.
S	3.8	± 0.5
d	0.8	± 0.05
H	4.5	Min.
R1	5.8	Max.
R2	7.0	Max.

Item	Dimensions	
	Spec.	Tolerance
D	5.0	± 0.1
T	7.2	± 0.3
T1	11.0	± 1.0
L	12.0	± 2.0
S	4.0	± 0.5
d	0.8	± 0.05
H	3.0	± 0.8
R1	5.8	Max.
R2	7.0	Max.



### 3 Electrode Symmetrical Series (3RSSM)

#### Specifications

Base Part Number	DC Breakdown Voltage (V)	Maximum Impulse Breakdown Voltage (V)		Maximum Impulse Discharge Current (8/20 $\mu$ s) (KA)		Alternating Discharge Current (A)		Impulse Life (10/1000 $\mu$ s) (200A)	DC Holdover Voltage (V)	Minimum Insulation Resistance (G $\Omega$ )	Maximum Capacitance (pf)
	100V/s NOTE 1	100V/ $\mu$ s NOTE 2	1000V/ $\mu$ s NOTE 2	1 time	10 times (5 times each polarity)	50Hz, 1 sec	Single 9 cycles	times	<150ms	*	1MHz
WPGT-3RSSM230	230 $\pm$ 20%	600	700	10	5	5	20	300	135	1	2.0
WPGT-3RSSM250	250 $\pm$ 20%	600	700	10	5	5	20	300	135	1	2.0
WPGT-3RSSM300	300 $\pm$ 20%	650	750	10	5	5	20	300	135	1	2.0
WPGT-3RSSM350	350 $\pm$ 20%	650	750	10	5	5	20	300	135	1	2.0
WPGT-3RSSM400	400 $\pm$ 20%	700	800	10	5	5	20	300	135	1	2.0
WPGT-3RSSM420	420 $\pm$ 20%	700	800	10	5	5	20	300	135	1	2.0
WPGT-3RSSM470	470 $\pm$ 20%	800	900	10	5	5	20	300	135	1	2.0
WPGT-3RSSM600	600 $\pm$ 20%	900	1000	10	5	5	20	300	135	1	2.0

**UL 497B Recognized, File #E135015.**

*DC Breakdown Voltage	DC Measuring Voltage
145 - 400V	100V
420 - 600V	250V

**NOTE 1:** DC Breakdown Voltage @ 100V/s for L1/L2 to ground and L1 to L2.

**NOTE 2:** Impulse Breakdown Voltage @ 100V/ $\mu$ s and 1000V/ $\mu$ s for L1/L2 to ground.

### 3 Electrode Symmetrical Series (3RSSM)

Dimensions in mm.

#### G1 TYPE

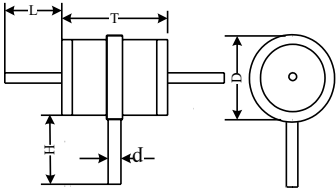

#### G1F TYPE

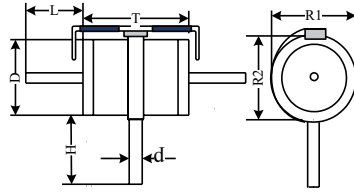

Item	Dimensions	
	Spec.	Tolerance
D	5.0	± 0.1
T	7.2	± 0.3
d	0.8	± 0.05
L	15.8	± 0.5
H	9.4	± 0.5
R1	5.8	Max.
R2	7.0	Max.

#### H TYPE(S) = 4.4 ± 0.5mm

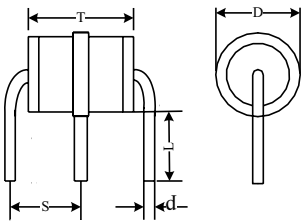

#### HF TYPE

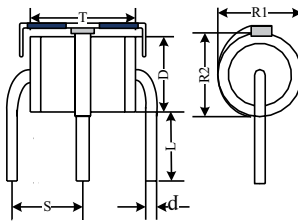

Item	Dimensions	
	Spec.	Tolerance
D	5.0	± 0.1
T	7.2	± 0.3
S	4.4	± 0.05
d	0.8	± 0.5
L	4.5	Min.
R1	5.8	Max.
R2	7.0	Max.

#### C3 TYPE(S) = 3.8 ± 0.5mm

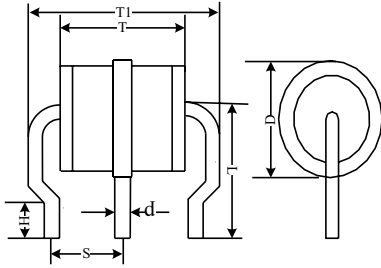

#### CF3 TYPE

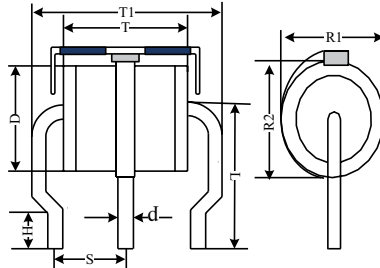

Item	Dimensions	
	Spec.	Tolerance
D	5.0	± 0.1
T	7.2	± 0.3
T1	12.0	Max.
L	12.0	Max.
S	3.8	± 0.5
d	0.8	± 0.05
H	4.5	Min.
R1	5.8	Max.
R2	7.0	Max.

#### C4 TYPE(S) = 4.0 ± 0.5

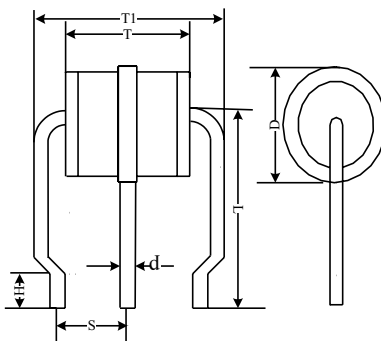

#### CF4 TYPE

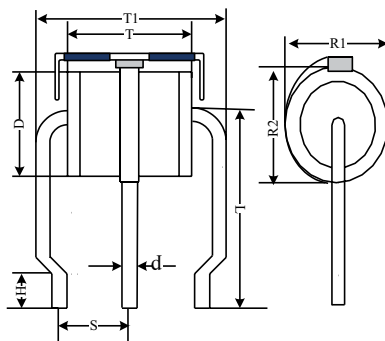

Item	Dimensions	
	Spec.	Tolerance
D	5.0	± 0.1
T	7.2	± 0.3
T1	11.0	± 1.0
L	12.0	± 2.0
S	4.0	± 0.5
d	0.8	± 0.05
H	3.0	± 0.8
R1	5.8	Max.
R2	7.0	Max.

## 3 Electrode Mini Series (3RM)

### Specifications

Base Part Number	DC Breakdown Voltage (V)	Maximum Impulse Breakdown Voltage (V)		Maximum Impulse Discharge Current (8/20 $\mu$ s) (KA)		Alternating Discharge Current (A)		Impulse Life (10/1000 $\mu$ s) (200A)	DC Holdover Voltage (V)	Minimum Insulation Resistance (G $\Omega$ )	Maximum Capacitance (pf)
	100V/s NOTE 1	100V/ $\mu$ s NOTE 2	1000V/ $\mu$ s NOTE 2	1 time	10 times (5 times each polarity)	50Hz, 1 sec	Single 9 cycles	times	<150ms	*	1MHz
WPGT-3RM90	90 $\pm$ 20%	500	600	15	10	10	60	300	52	10	1.5
WPGT-3RM145	145 $\pm$ 20%	500	600	15	10	10	60	300	52	10	1.5
WPGT-3RM200	200 $\pm$ 20%	550	650	15	10	10	60	300	135	10	1.5
WPGT-3RM230	230 $\pm$ 20%	600	700	15	10	10	60	300	135	10	1.5
WPGT-3RM250	250 $\pm$ 20%	600	700	15	10	10	60	300	135	10	1.5
WPGT-3RM350	350 $\pm$ 20%	650	750	15	10	10	60	300	150	10	1.5
WPGT-3RM400	400 $\pm$ 20%	700	800	15	10	10	60	300	150	10	1.5
WPGT-3RM420	420 $\pm$ 20%	700	800	15	10	10	60	300	150	10	1.5
WPGT-3RM470	470 $\pm$ 20%	800	900	15	10	10	60	300	150	10	1.5
WPGT-3RM600	600 $\pm$ 20%	900	1000	10	5	5	30	300	150	10	1.5

UL497B Recognized, File #E135015

*DC Breakdown Voltage	DC Measuring Voltage
90V	50V
145-400V	100V
420-600V	250V

NOTE 1: DC Breakdown Voltage @ 100V/s for L1/L2 to ground.

NOTE 2: Impulse Breakdown Voltage @ 100V/ $\mu$ s and 1000V/ $\mu$ s for L1/L2 to ground.

### Dimensions

Unit: mm

Item	Dimensions (mm)
D	6.0 +0.2, -0.5
T	8.5 $\pm$ 0.5
T1	11.5 +0.8, -0.5
L	7.0 $\pm$ 0.5
S	3.8 $\pm$ 0.5 or 4.4 $\pm$ 0.5
d	0.8 $\pm$ 0.05
L1	2.5 $\pm$ 0.5
R1	6.3 $\pm$ 0.3
R2	7.6 $\pm$ 0.4

C3 TYPE (S) = 3.8  $\pm$  0.5mm

H TYPE (S) = 4.4  $\pm$  0.5mm

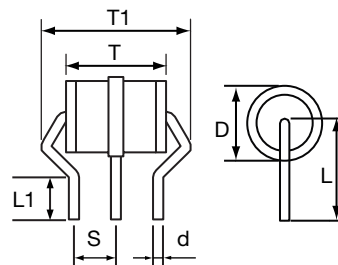

B TYPE

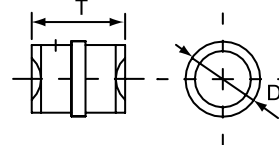

G1 TYPE (d) = 0.8mm

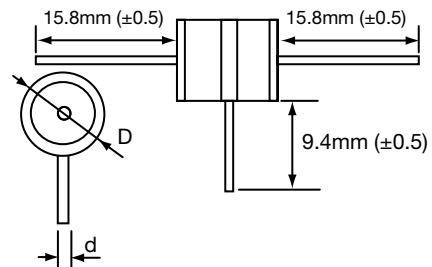

CF1 TYPE

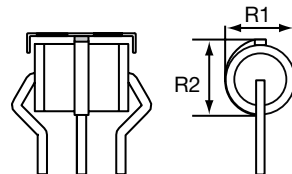

### Failsafe Current - Time Curve

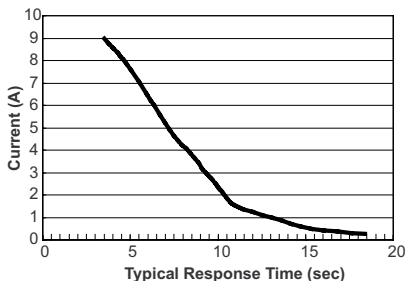

## 3 Electrode Standard Series (3R)

### Specifications

Base Part Number	DC Breakdown Voltage (V)	Maximum Impulse Breakdown Voltage (V)		Maximum Impulse Discharge Current (8/20 $\mu$ s) (KA)		Alternating Discharge Current (A)		Impulse Life (10/1000 $\mu$ s) (400A)	DC Holdover Voltage (V)	Minimum Insulation Resistance (G $\Omega$ )	Maximum Capacitance (pf)
	100V/s NOTE 1	100V/ $\mu$ s NOTE 2	1000V/ $\mu$ s NOTE 2	1 time	10 times (5 times each polarity)	50Hz, 1 sec	Single 9 cycles	times	<150ms	*	1MHz
WPGT-3R75	75 $\pm$ 20%	500	600	40	20	20	130	300	52	10	1.5
WPGT-3R90	90 $\pm$ 20%	500	600	40	20	20	130	300	52	10	1.5
WPGT-3R145	145 $\pm$ 20%	500	600	40	20	20	130	300	52	10	1.5
WPGT-3R200	200 $\pm$ 20%	500	650	40	20	20	130	300	135	10	1.5
WPGT-3R230	230 $\pm$ 20%	600	650	40	20	20	130	300	135	10	1.5
WPGT-3R250	250 $\pm$ 20%	600	700	40	20	20	130	300	135	10	1.5
WPGT-3R260	260 $\pm$ 20%	600	700	40	20	20	130	300	135	10	1.5
WPGT-3R300	300 $\pm$ 20%	700	800	40	20	20	130	300	135	10	1.5
WPGT-3R350	350 $\pm$ 20%	700	850	40	20	20	130	300	150	10	1.5
WPGT-3R400	400 $\pm$ 20%	800	900	40	20	20	130	300	150	10	1.5
WPGT-3R470	470 $\pm$ 20%	900	1000	40	20	20	130	300	150	10	1.5
WPGT-3R550	550 $\pm$ 20%	950	1050	40	20	20	130	300	150	10	1.5
WPGT-3R600	600 $\pm$ 20%	1000	1100	40	20	20	130	300	150	10	1.5

NOTE: Above updated specifications as of 01.30.13 (Rev. 13.3) apply for date code 1306 and newer.

#### UL497B Recognized, File #E135015

*DC Breakdown Voltage	DC Measuring Voltage
70-90V	50V
145-400V	100V
470-600V	250V

**NOTE 1:** DC Breakdown Voltage @ 100V/s for L1/L2 to ground.

**NOTE 2:** Impulse Breakdown Voltage @ 100V/ $\mu$ s and 1000V/ $\mu$ s for L1/L2 to ground.

### Dimensions

Unit: mm

Item	Dimensions (mm)
D	8.0 $\pm$ 0.2
T	10.0 $\pm$ 0.5
T1	13.4 $\pm$ 0.4
L	11.0 $\pm$ 0.5

Item	Dimensions (mm)
L1	4.5 +1.5/-0
R1	8.1 $\pm$ 0.3
R2	9.8 $\pm$ 0.4
S	4.4 $\pm$ 0.5
d	1.0 $\pm$ 0.05

**C TYPE** (d) = 1.0mm  
**C2 TYPE** (d) = 0.8mm

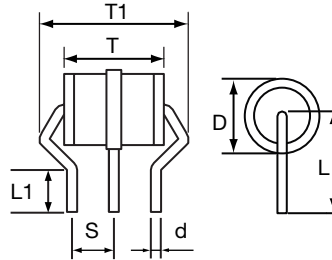

**B TYPE**

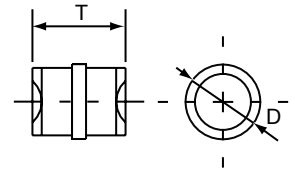

### Failsafe Current - Time Curve

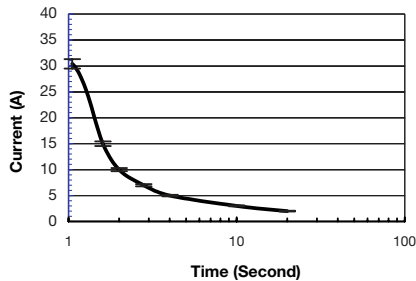

**G TYPE** (d) = 1.0mm  
**G1 TYPE** (d) = 0.8mm

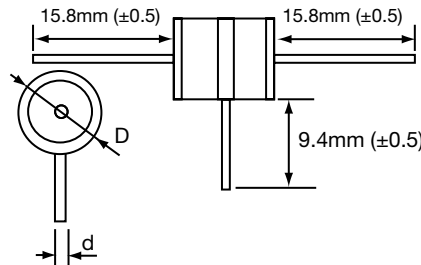

**CF TYPE\*\*** (d) = 1.0mm  
**CF1 TYPE** (d) = 0.8mm

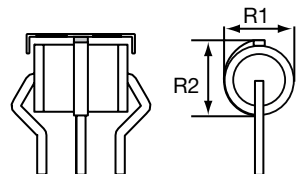

**THIS PAGE INTENTIONALLY LEFT BLANK.**

## 2 & 3 Electrode Surface Mount Series

### Part Numbering System

Example part number:

WPGT - 3SSM 230 D TR  
 (1) (2) (3) (4) (5)

**(1) World Products Gas Discharge Tubes**

**(2) Series Code**

- 2SM** = 2 Electrode Surface Mount Mini Series
- 2S** = 2 Electrode Surface Mount Standard Series
- 2SS** = 2 Electrode Surface Mount Mini Square Series
- 2SR** = 2 Electrode Surface Mount Standard Low Profile Series
- 3216\*** = 2 Electrode Surface Mount Chip Series
- 4532\*** = 2 Electrode Surface Mount Chip Series
- 3SM** = 3 Electrode Surface Mount Mini Series
- 3SSM** = 3 Electrode Surface Mount Symmetrical Series

**(3) DC Breakdown Voltage**

**(Please reference specification to determine available voltage options for each series.)**

- 70** = 70V
- 75** = 75V
- 90** = 90V
- 120** = 120V
- 145** = 145V
- 150** = 150V
- 200** = 200V
- 230** = 230V
- 250** = 250V
- 300** = 300V
- 350** = 350V
- 400** = 400V
- 420** = 420V
- 470** = 470V
- 500** = 500V
- 600** = 600V
- 800** = 800V
- 1100** = 1100V
- 1200** = 1200V
- 1800** = 1800V
- 2000** = 2000V
- 2500** = 2500V
- 2700** = 2700V
- 3000** = 3000V

**(4) D = Special DC Voltage Breakdown - 3SSM Series Only**

**(5) Taping Specifications**

**TR** = Tape & Reel

\* 3216 and 4532 only available on tape and reel "TR" suffix.

## 2 Electrode Surface Mount Mini Series (2SM)

### Specifications

Base Part Number	DC Breakdown Voltage (V)	Maximum Impulse Breakdown Voltage (V)		Maximum Impulse Discharge Current (8/20 $\mu$ s) (KA)		Alternating Discharge Current (A)		Impulse Life (10/1000 $\mu$ s) (100A)	DC Holdover Voltage (V)	Minimum Insulation Resistance (G $\Omega$ )	Maximum Capacitance (pf)
	100V/s	100V/ $\mu$ s	1000V/ $\mu$ s	1 time	10 times (5 times each polarity)	50Hz, 1 sec	Single 9 cycles	times	<150ms	*	1MHz
WPGT-2SM75	75 $\pm$ 20%	700	800	5	3	3	6	300	52	1	0.5
WPGT-2SM90	90 $\pm$ 20%	700	800	5	3	3	6	300	52	1	0.5
WPGT-2SM145	145 $\pm$ 20%	700	800	5	3	3	6	300	52	1	0.5
WPGT-2SM230	230 $\pm$ 20%	600	700	5	3	3	6	300	135	1	0.5
WPGT-2SM250	250 $\pm$ 20%	600	700	5	3	3	6	300	135	1	0.5
WPGT-2SM300	300 $\pm$ 20%	600	700	5	3	3	6	300	135	1	0.5
WPGT-2SM350	350 $\pm$ 20%	650	800	5	3	3	6	300	135	1	0.5
WPGT-2SM400	400 $\pm$ 20%	700	800	5	3	3	6	300	135	1	0.5
WPGT-2SM470	470 $\pm$ 20%	700	800	5	3	3	6	300	135	1	0.5
WPGT-2SM600	600 $\pm$ 20%	900	1000	5	3	3	6	300	135	1	0.5

#### UL497B Recognized, File #E135015

*DC Breakdown Voltage	DC Measuring Voltage
75-90V	50V
145-400V	100V
470-600V	250V

### Dimensions

Unit: mm

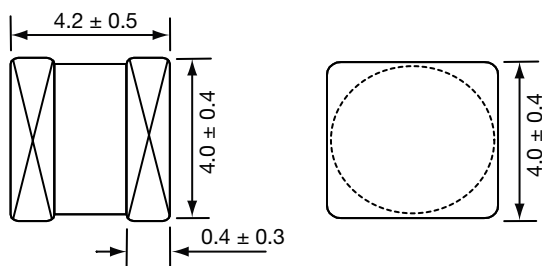

### Recommended Pad Size

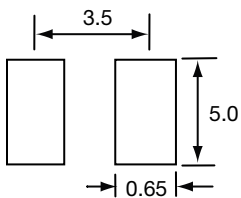

## 2 Electrode Surface Mount Mini Square Series (2SS)

### Specifications

Base Part Number	DC Breakdown Voltage (V)	Maximum Impulse Breakdown Voltage (V)		Maximum Impulse Discharge Current (8/20 $\mu$ s) (KA)		Alternating Discharge Current (A)		Impulse Life (10/1000 $\mu$ s) (100A)	DC Holdover Voltage (V)	Minimum Insulation Resistance (G $\Omega$ )	Maximum Capacitance (pf)
	100V/s	100V/ $\mu$ s	1000V/ $\mu$ s	1 time	10 times (5 times each polarity)	50Hz, 1 sec	Single 9 cycles	times	<150ms	*	1MHz
WPGT-2SS75	75 $\pm$ 20%	700	800	5	3	3	6	300	52	1	0.5
WPGT-2SS90	90 $\pm$ 20%	700	800	5	3	3	6	300	52	1	0.5
WPGT-2SS145	145 $\pm$ 20%	700	800	5	3	3	6	300	52	1	0.5
WPGT-2SS230	230 $\pm$ 20%	600	700	5	3	3	6	300	135	1	0.5
WPGT-2SS250	250 $\pm$ 20%	600	700	5	3	3	6	300	135	1	0.5
WPGT-2SS300	300 $\pm$ 20%	600	700	5	3	3	6	300	135	1	0.5
WPGT-2SS350	350 $\pm$ 20%	650	800	5	3	3	6	300	135	1	0.5
WPGT-2SS400	400 $\pm$ 20%	700	800	5	3	3	6	300	135	1	0.5
WPGT-2SS470	470 $\pm$ 20%	700	800	5	3	3	6	300	135	1	0.5
WPGT-2SS600	600 $\pm$ 20%	900	1000	5	3	3	6	300	135	1	0.5

#### UL 497B Recognition, File #E135015

*DC Breakdown Voltage	DC Measuring Voltage
70-90V	50V
145-400V	100V
470-600V	250V

### Dimensions

Unit: mm

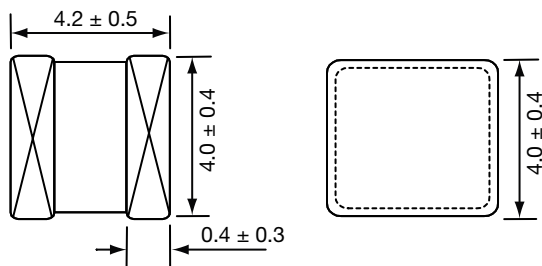

### Recommended Pad Size

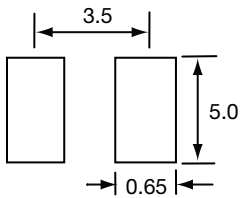

**Note:** This product has a square ceramic body.



## 2 Electrode Surface Mount Standard Series (2S)

### Specifications

Base Part Number	DC Breakdown Voltage (V)	Maximum Impulse Breakdown Voltage (V)		Maximum Impulse Discharge Current (8/20 $\mu$ s) (KA)		Alternating Discharge Current (A)		Impulse Life (10/1000 $\mu$ s) (100A)	DC Holdover Voltage (V)	Minimum Insulation Resistance (G $\Omega$ )	Maximum Capacitance (pf)
	100V/s	100V/ $\mu$ s	1000V/ $\mu$ s	1 time	10 times (5 times each polarity)	50Hz, 1 sec	Single 9 cycles	times	<150ms	*	1MHz
WPGT-2S75	75 $\pm$ 20%	600	700	8	5	5	15	1000	52	1	1
WPGT-2S90	90 $\pm$ 20%	600	700	8	5	5	15	1000	52	1	1
WPGT-2S145	145 $\pm$ 20%	500	700	8	5	5	15	1000	52	1	1
WPGT-2S230	230 $\pm$ 20%	450	550	8	5	5	15	1000	135	1	1
WPGT-2S250	250 $\pm$ 20%	450	550	8	5	5	15	1000	135	1	1
WPGT-2S300	300 $\pm$ 20%	500	600	8	5	5	15	1000	135	1	1
WPGT-2S350	350 $\pm$ 20%	500	600	8	5	5	15	1000	135	1	1
WPGT-2S400	400 $\pm$ 20%	600	700	8	5	5	15	1000	135	1	1
WPGT-2S470	470 $\pm$ 20%	700	800	8	5	5	15	1000	135	1	1
WPGT-2S600	600 $\pm$ 20%	800	900	8	5	5	15	1000	135	1	1
WPGT-2S1200	1200 $\pm$ 20%	1700	1800	8	5	5	10	300	150	1	1
WPGT-2S1800	1800 $\pm$ 20%	2500	2600	5	3	3	10	300	150	1	1
WPGT-2S2000	2000 $\pm$ 20%	2700	2800	5	3	3	10	300	150	1	1
WPGT-2S2500	2500 $\pm$ 20%	3100	3200	5	3	3	10	300	150	1	1
WPGT-2S2700	2700 $\pm$ 20%	3300	3400	5	3	3	10	300	150	1	1
WPGT-2S3000	3000 $\pm$ 20%	3600	3700	5	3	3	10	300	150	1	1

UL497B Recognized, File #E135015 (WPGT-2S75 through WPGT-2S600)

UL1449 and C-UL 3rd Edition Recognized, File #E321567 (WPGT-2S1200 through WPGT-2S3000)

\*DC Breakdown Voltage  
70-90V  
145-400V  
470-600V  
1200-2000V

DC Measuring Voltage  
50V  
100V  
250V  
550V

### Dimensions

Unit: mm

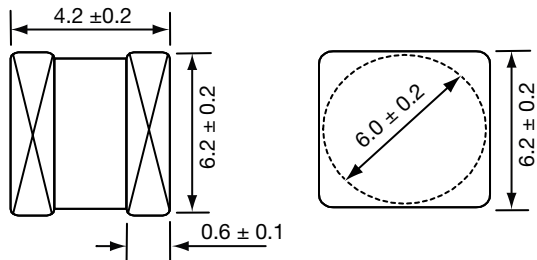

### Recommended Pad Size

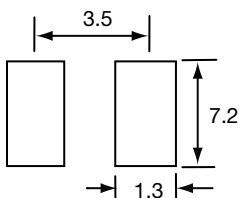

## 2 Electrode Surface Mount Standard Low Profile Series (2SR)

### Specifications

Base Part Number	DC Breakdown Voltage (V)	Maximum Impulse Breakdown Voltage (V)		Maximum Impulse Discharge Current (8/20µs) (KA)		Alternating Discharge Current (A)		Impulse Life (10/1000µs) (100A)	DC Holdover Voltage (V)	Minimum Insulation Resistance (GΩ)	Maximum Capacitance (pf)
	100V/s	100V/µs	1000V/µs	1 time	10 times (5 times each polarity)	50Hz, 1 sec	Single 9 cycles	times	<150ms	*	1MHz
WPGT-2SR75	75 ± 20%	600	700	5	5	5	15	300	52	1	0.5
WPGT-2SR90	90 ± 20%	600	700	5	5	5	15	300	52	1	0.5
WPGT-2SR145	145 ± 20%	500	700	5	5	5	15	300	52	1	0.5
WPGT-2SR230	230 ± 20%	500	600	5	5	5	15	300	80	1	0.5
WPGT-2SR250	250 ± 20%	500	600	5	5	5	15	300	135	1	0.5
WPGT-2SR300	300 ± 20%	550	650	5	5	5	15	300	150	1	0.5
WPGT-2SR350	350 ± 20%	600	700	5	5	5	15	300	150	1	0.5
WPGT-2SR400	400 ± 20%	650	750	5	5	5	15	300	150	1	0.5
WPGT-2SR470	470 ± 20%	750	850	5	5	5	15	300	150	1	0.5
WPGT-2SR600	600 ± 20%	900	1000	5	5	5	15	300	150	1	0.5

#### UL497B - Pending

\*DC Breakdown Voltage  
70-90V  
145-400V  
470-600V

DC Measuring Voltage  
50V  
100V  
250V

### Dimensions

Unit: mm

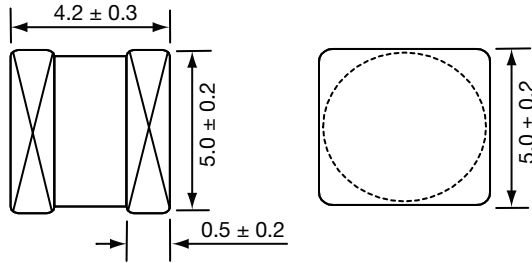

### Recommended Pad Size

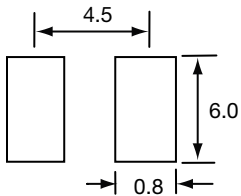

## 2 Electrode Surface Mount Chip Series (3216)

### Specifications

Base Part Number	DC Breakdown Voltage (V)		Maximum Impulse Breakdown Voltage (V)		Maximum Impulse Discharge Current (8/20us) (KA)	Alternating Discharge Current (A)		Impulse Life (8/20us)50A times	Minimum Insulation Resistance (1MΩ) *	Maximum Capacitance (pf) 1MHz 1V
	100V/s	100V/μs	1000V/μs	10 times (5 times each polarity)		50Hz, 1 sec	10 times			
WP-3216-120	84 - 156	500	650	0.5	0.5	300	100 min	0.3 max		
WP-3216-150**	105 - 195	500	650							
WP-3216-200**	140 - 260	600	700							
WP-3216-230	161 - 299	650	750							
WP-3216-300	210 - 390	700	800							
WP-3216-350	245 - 455	750	850							
WP-3216-400**	280 - 520	800	900							
WP-3216-420**	294 - 546	850	950							
WP-3216-470	329 - 611	900	1000							
WP-3216-500**	350 - 650	900	1000							
WP-3216-600**	420 - 780	1000	1100							

**Note:** \*\*UL1449 and C-UL 3rd Edition recognized. File #E321567. All other values are pending.

*DC Breakdown Voltage	DC Measuring Voltage
70 - 120V	50V
150 - 600V	100V

### Dimensions

Unit: mm

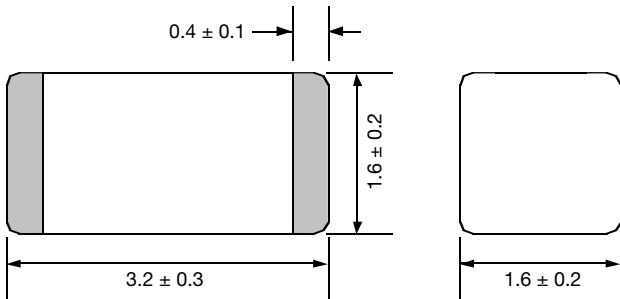

### Recommended Pad Size

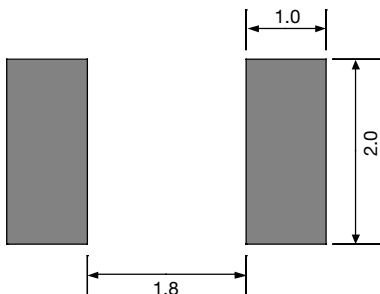

## 2 Electrode Surface Mount Chip Series (4532)

### Specifications

Base Part Number	DC Breakdown Voltage (V)		Maximum Impulse Breakdown Voltage (V)		Maximum Impulse Discharge Current (8/20us) (KA)	Alternating Discharge Current (A)		Impulse withstanding voltage capacity (KV)		Impulse Life (8/20us) 100A	Minimum Insulation Resistance (1GΩ)	Maximum Capacitance (pf)
	100V/s	100V/μs	1000V/μs	10 times (5 times each polarity)		50Hz, 1 sec	10 times	10/700us R=25Ω	10 times (5 times each polarity)			
WP-4532-75	55 - 95	500	650	2	2	4	300	1	0.5 max.			
WP-4532-90	63 - 117	500	650									
WP-4532-120	84 - 156	500	650									
WP-4532-150	105 - 195	500	650									
WP-4532-200	140 - 260	600	700									
WP-4532-230	161 - 299	650	750									
WP-4532-300	210 - 390	700	800									
WP-4532-350	245 - 455	750	850									
WP-4532-400	280 - 520	800	900									
WP-4532-420	294 - 546	850	950									
WP-4532-470	329 - 611	900	1000									
WP-4532-500	350 - 650	900	1000									
WP-4532-600	420 - 780	1000	1100									

#### UL497B Recognized, File #E135015

*DC Breakdown Voltage	DC Measuring Voltage
70 - 120V	50V
150 - 600V	100V

### Dimensions

Unit: mm

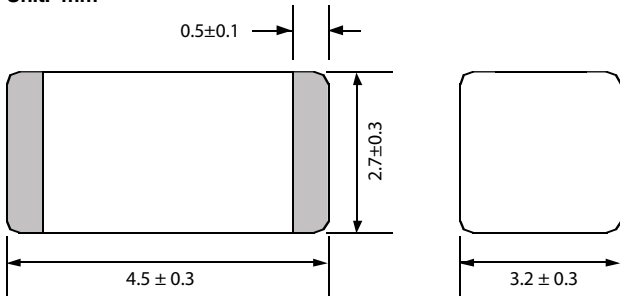

### Recommended Pad Size

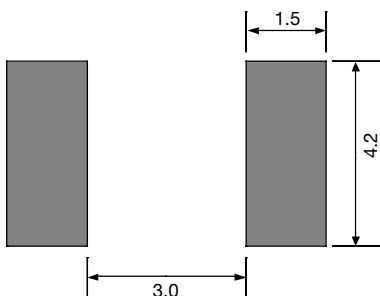

## 3 Electrode Surface Mount Mini Series (3SM)

### Specifications

Base Part Number	DC Breakdown Voltage (V)	Maximum Impulse Breakdown Voltage (V)		Maximum Impulse Discharge Current (8/20 $\mu$ s) (KA)		Alternating Discharge Current (A)		Impulse Life (10/1000 $\mu$ s) (200A)	DC Holdover Voltage (V)	Minimum Insulation Resistance (G $\Omega$ )	Maximum Capacitance (pf)
	100V/s NOTE 1	100V/ $\mu$ s NOTE 2	1000V/ $\mu$ s NOTE 2	1 time	10 times (5 times each polarity)	50Hz, 1 sec	Single 9 cycles	times	<150ms	*	1MHz
WPGT-3SM75	75 $\pm$ 20%	300	550	10	5	5	30	300	52	1	2
WPGT-3SM90	90 $\pm$ 20%	300	550	15	10	10	60	300	52	1	2
WPGT-3SM120	120 $\pm$ 20%	350	550	15	10	10	60	300	52	1	2
WPGT-3SM150	150 $\pm$ 20%	400	500	15	10	10	60	300	52	1	2
WPGT-3SM200	200 $\pm$ 20%	500	600	15	10	10	60	300	135	1	2
WPGT-3SM230	230 $\pm$ 20%	550	650	15	10	10	60	300	135	1	2
WPGT-3SM250	250 $\pm$ 20%	550	650	15	10	10	60	300	135	1	2
WPGT-3SM300	250 $\pm$ 20%	600	700	20	10	10	60	300	150	1	2
WPGT-3SM350	350 $\pm$ 20%	650	750	20	10	10	60	300	150	1	2
WPGT-3SM400	400 $\pm$ 20%	700	800	20	10	10	60	300	150	1	2
WPGT-3SM420	420 $\pm$ 20%	700	800	10	5	5	30	300	150	1	2
WPGT-3SM470	470 $\pm$ 20%	800	900	10	5	5	30	300	150	1	2
WPGT-3SM600	600 $\pm$ 20%	900	1000	10	5	5	30	300	150	1	2
WPGT-3SM800	800 $\pm$ 20%	1150	1400	10	5	5	30	300	150	1	2
WPGT-3SM1100	1100 $\pm$ 20%	1450	1750	10	5	5	30	300	150	1	2

UL 497B Recognized, File #E135015 (WPGT-3SM75 through WPGT-3SM600).

UL 1449 and C-UL 3rd Edition Recognition, File #E321567 (WPGT-3SM800 and WPGT-3SM1100)

*DC Breakdown Voltage	DC Measuring Voltage
70 - 90	50V
120 - 400V	100V
470 - 1000V	250V
1001 - 2000V	500V

**NOTE 1:** DC Breakdown Voltage @ 100V/s for L1/L2 to ground.

**NOTE 2:** Impulse Breakdown Voltage @ 100V/ $\mu$ s and 1000V/ $\mu$ s for L1/L2 to ground.

### Dimensions

Unit: mm

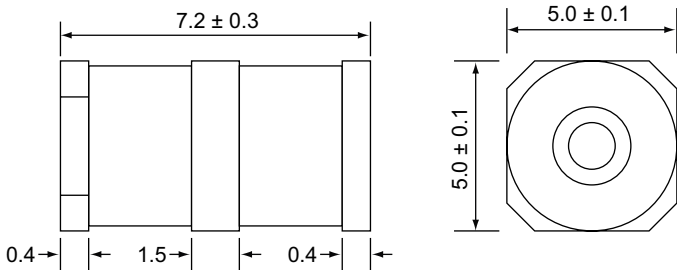

### Recommended Pad Size

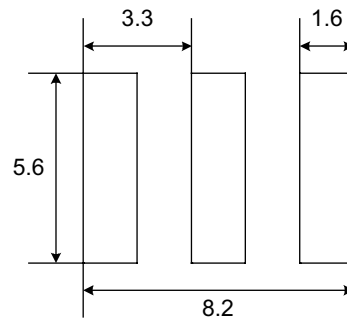

**Note:** Max coplanarity is 0.2mm. If tighter requirements are needed please contact World Products, LLC

## 3 Electrode Surface Mount Symmetrical Series (3SSM)

### Specifications

Base Part Number	DC Breakdown Voltage (V)	Maximum Impulse Breakdown Voltage (V)		Maximum Impulse Discharge Current (8/20 $\mu$ s) (KA)		Alternating Discharge Current (A)		Impulse Life (10/1000 $\mu$ s) (200A)	DC Holdover Voltage (V)	Minimum Insulation Resistance (G $\Omega$ )	Maximum Capacitance (pf)
	100V/s NOTE 1	100V/ $\mu$ s NOTE 2	1000V/ $\mu$ s NOTE 2	1 time	10 times (5 times each polarity)	50Hz, 1 sec	Single 9 cycles	times	<150ms	*	1MHz
WPGT-3SSM230	230 $\pm$ 20%	550	650	10	5	5	20	300	135	1	2.0
WPGT-3SSM250	250 $\pm$ 20%	600	700	10	5	5	20	300	135	1	2.0
WPGT-3SSM300	300 $\pm$ 20%	650	750	10	5	5	20	300	135	1	2.0
WPGT-3SSM350	350 $\pm$ 20%	650	750	10	5	5	20	300	135	1	2.0
WPGT-3SSM400	400 $\pm$ 20%	700	850	10	5	5	20	300	135	1	2.0
WPGT-3SSM420	420 $\pm$ 20%	700	850	10	5	5	20	300	135	1	2.0
WPGT-3SSM470	470 $\pm$ 20%	800	950	10	5	5	20	300	135	1	2.0
WPGT-3SSM600	600 $\pm$ 20%	900	1100	10	5	5	20	300	135	1	2.0
WPGT-3SSM800	800 $\pm$ 20%	1150	1400	10	5	5	20	300	135	1	2.0
WPGT-3SSM1100	1100 $\pm$ 20%	1450	1750	10	5	5	20	300	135	1	2.0

UL 497B Recognized, File #E135015 (WPGT-3SSM230 through WPGT-3SSM600).

UL 1449 and C-UL 3rd Edition Recognized, File #E321567 (WPGT-3SSM800 and WPGT-3SSM1100).

*DC Breakdown Voltage	DC Measuring Voltage
230 - 400V	100V
420 - 800V	250V
1100V	500V

**NOTE 1:** DC Breakdown voltage @ 100V/s for L1/L2 to ground and L1 to L2.

**NOTE 2:** Impulse Breakdown voltage @ 100V/ $\mu$ s and 1000V/ $\mu$ s for L1/L2 to ground.

### Dimensions

Unit: mm

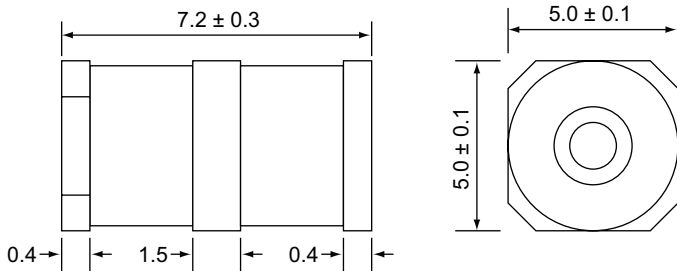

### Recommended Pad Size

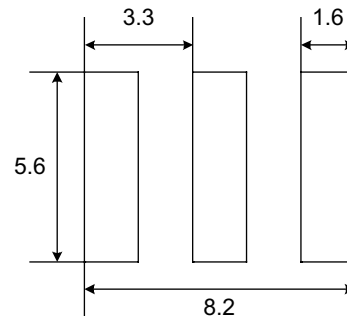

**Note:** Max coplanarity is <0.1mm.

## Packaging

### Standard Bulk Packaging

<b>Axial or Radial Lead</b> 100 pieces per plastic tray 500 pieces per inner box 10 inner boxes per carton 5000 pieces per full carton	<b>Surface Mount</b> 1000 pieces per plastic airproof bag 2 plastic bags per inner box 10 inner boxes per carton 20000 pieces per full carton	<b>20B ONLY</b> 40 pieces per plastic tray 200 pieces per inner box 10 inner boxes per carton 2000 pieces per full carton
----------------------------------------------------------------------------------------------------------------------------------------------------	-----------------------------------------------------------------------------------------------------------------------------------------------------------	---------------------------------------------------------------------------------------------------------------------------------------

### 2RM, 2R, 2N, 2T Axial Lead Taping

**Unit: mm**  
Complies to EIA-296-E and EN60286-1.

Item	Dimensions
L1	52.4 ± 1.5
L	63.5 ± 1.5
D	10 ± 0.5
F	Length + 1.4 Max.

### 2RM, 2R, 2N, 2T Axial Lead Ammo Box

**Unit: mm**  
**Quantity: 500 pieces**

Item	Dimensions
A	255 Max.
B	75 ± 5.0
C	68 ± 5.0

### 2RM, 2R, 2N, 2T Axial Lead Reel

**Unit: mm**  
**Quantity: 500 pieces**

### 2S, 2SM, 2SS, 3SM, 3SSM, 3216 & 4532 SMD Reel

**Unit: mm**  
**Quantity: See SMD Taping**

\* for 3216 this dimension is 60 typ.  
\*\* for 3216 this dimension is 15 typ.

### 20B and AE Standard Bulk Packaging

**Unit: mm**

<b>20B=</b> 40 Pieces per Plastic Tray	200 Pieces per Inner Box	2000 Pieces per Full Carton
<b>AE=</b> 60 Pieces per Plastic Tray <small>(Standard &amp; High Current Series)</small>	180 Pieces per Inner Box	1800 Pieces per Full Carton
<small>(Ultra High Current &amp; Screw Lead Series)</small>	105 Pieces per Inner Box	1050 Pieces per Full Carton

## Packaging (continued)

### 2S and 2SR SMD Taping

Unit: mm

Quantity: 800 pieces per reel (13") - [Beginning March 2007]  
 3 reels per inner box  
 5 inner boxes per carton  
 12,000 pieces per full carton - [Beginning March 2007]

Item	Dimensions
P	12.0 ± 0.1
P <sub>0</sub>	4.0 ± 0.1
W	16.0 ± 0.3
F	7.5 ± 0.1

Item	Dimensions
E	1.75 ± 0.1
D	1.55 ± 0.1
K*	6.4 ± 0.1
t*	0.4 ± 0.05

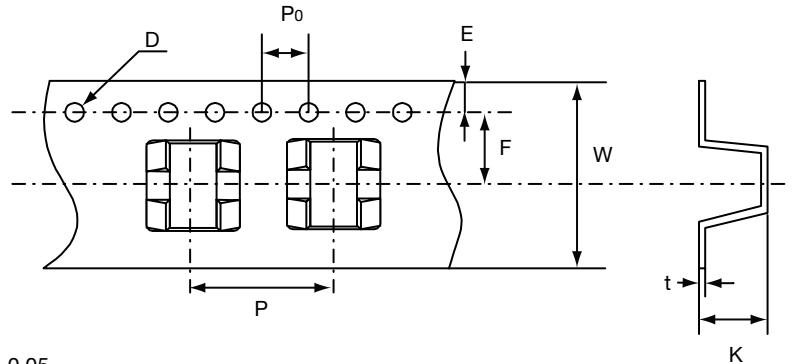

\*For 2SR: "K" dimension is 5.6 ± 0.1 and "t" dimension is 0.5 ± 0.05

### 2SM and 2SS SMD Taping

Unit: mm

Quantity: 900 pieces per reel (13")  
 3 reels per inner box  
 5 inner boxes per carton  
 13,500 pieces per full carton

Item	Dimensions
P	12.0 ± 0.1
P <sub>0</sub>	4.0 ± 0.1
W	16.0 ± 0.3
F	7.5 ± 0.1
B <sub>0</sub>	4.3 ± 0.1

Item	Dimensions
E	1.75 ± 0.1
D	1.5 ± 0.1
t	0.5 typ
A <sub>0</sub>	4.5 ± 0.1
K <sub>0</sub>	4.6 ± 0.1
K <sub>1</sub>	0 ± 0.1
D <sub>1</sub>	0 ± 0.1
P <sub>2</sub>	2 ± 0.1

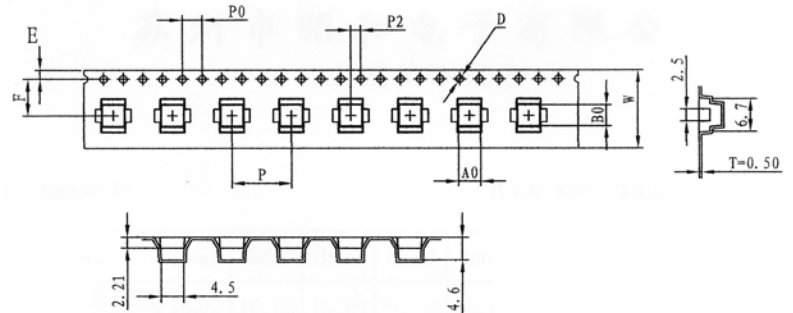

### 3SM & 3SSM SMD Taping

Unit: mm

Quantity: 900 pieces per reel (13")  
 3 reels per inner box  
 5 inner boxes per carton  
 13,500 pieces per full carton

Item	Dimensions
P	12.0 ± 0.1
P <sub>0</sub>	4.0 ± 0.1
W	16.0 ± 0.3
F	7.5 ± 0.1
B	5.4 ± 0.1

Item	Dimensions
E	1.75 ± 0.1
D	1.55 ± 0.05
K	5.5 ± 0.1
t	0.5 ± 0.05
A	7.28 ± 0.1

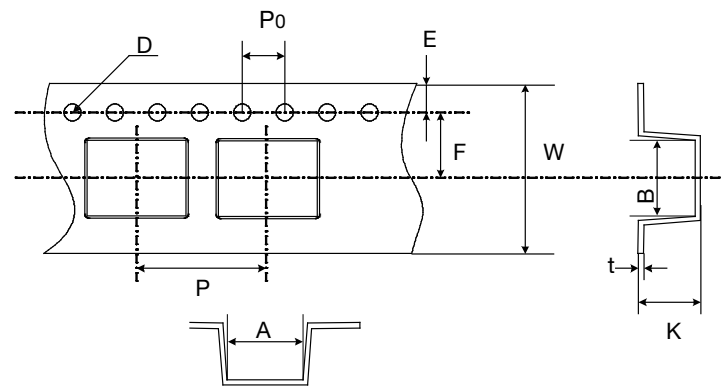



## Packaging (continued)

### 3216 and 4532 Taping

Unit: mm

Quantity: 3,000 pieces per reel (13") - 3216 size  
 2,500 pieces per reel (13") - 4532 size  
 3 reels per inner box - 3216 and 4532 size  
 5 inner boxes per carton - 3216 and 4532 size  
 45,000 pieces per full carton - 3216 size  
 37,500 pieces per full carton - 4532 size

Item	Dimensions
P	8.0 ± 0.1
P <sub>0</sub>	4.0 ± 0.1
W	12.0 ± 0.3
F	5.45 ± 0.1
E	1.75 ± 0.1

Item	Dimensions
D	1.55 ± 0.05
K*	3.0 ± 0.1
t	0.3 ± 0.05

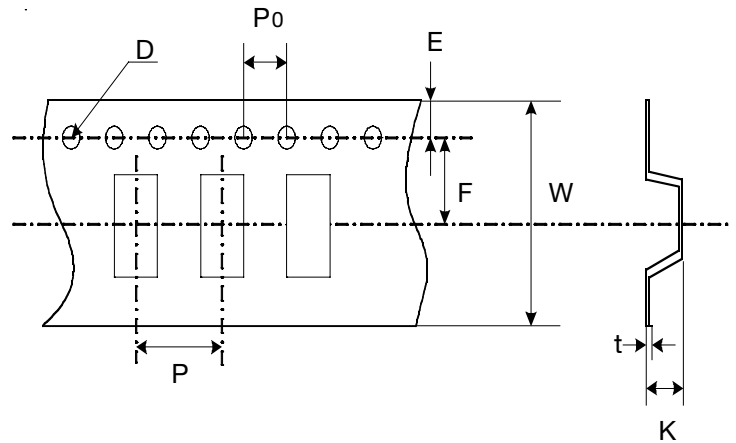

\* for 3216 this dimension is 1.8 ± 0.1

# GAS DISCHARGE TUBES

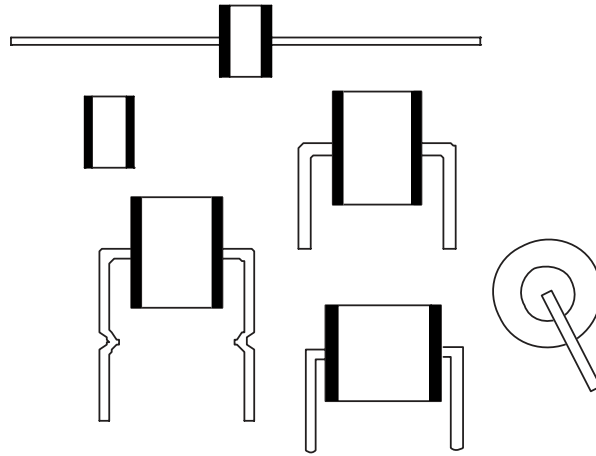

**Gas Discharge Tube** are designed to limit voltage surges on balanced or unbalanced communications circuits and on DC to 420 Hz power circuits. Although telephone circuits are a major application for gas tube surge arrestors, this guide will also provide useful information for other surge applications such as AC circuits.

**Gas Tube in Antenna Protection**

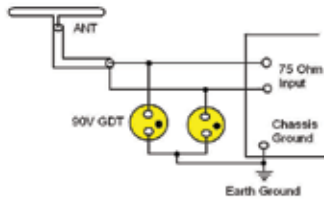

**GDT in Cable Protection**

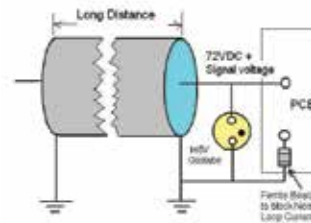

**Motor (two wire System) Protection from Lightning**

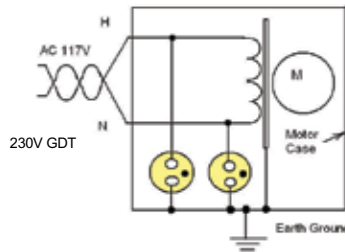

**Gas Tube Application In AC Line Isolation**

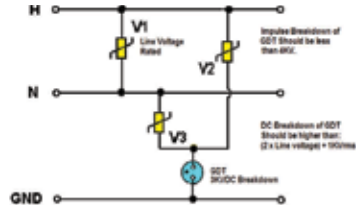

**GDT & TVSD Telephone Line Protection**

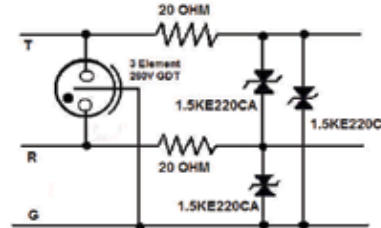

All application notes/circuits are shown as examples only. It is the responsibility of the purchaser to insure that the application meets purchaser's specifications. No representation or warranty, whether express or implied, is given and no liability is assumed by WPI with respect to the use of such examples.

WPI Reserves Copyright

**DISCLAIMER:** The names of the products and the specifications in this catalog are subject to change without notice for the sake of improvement. World Products, LLC also reserves the right to discontinue any of these products. The products in this catalog are intended for use in ordinary electronic products. If any of these products are to be used in special applications requiring extremely high reliability, where product defects might pose a safety risk, please consult World Products, LLC. Though World Products, LLC has taken all possible precautions to ensure the quality and reliability of its products, improper use of products may result in bodily injury, fire, or similar accident. If you have any questions regarding the use of the products in question, please consult World Products, LLC. Please be advised that World Products, LLC accepts no responsibility for any infringement by users of World Products, LLC products on third party patents or industrial copyrights.