

PA35

FEATURES

- LOW COST
- WIDE COMMON MODE RANGE — Includes negative supply
- WIDE SUPPLY VOLTAGE RANGE
Single supply: 5V to 40V
Split supplies: $\pm 2.5V$ to $\pm 20V$
- HIGH EFFICIENCY — $|V_s - 1.4V|$ at 1.0A typ
- HIGH OUTPUT CURRENT — 1.7A min
- INTERNAL CURRENT LIMIT
- LOW DISTORTION

APPLICATIONS

- HALF & FULL BRIDGE MOTOR DRIVERS
- AUDIO POWER AMPLIFIER
- IDEAL FOR SINGLE SUPPLY SYSTEMS
5V — Peripherals
12V — Automotive
28V — Avionic

DESCRIPTION

The PA35 consists of a monolithic power op amp with a unity gain buffer in a 7-pin TO220 package. The 7-pin TO220 flat back heat tab allows for heat sinking with an electrically insulating thermal washer. The tab of the 7-pin TO220 plastic package is tied to $-V_s$.

Combining the power amp and the unity gain buffer in a parallel connection yields a single 3.4A amplifier. The wide common mode input range includes the negative rail, facilitating single supply applications. It is possible to have a "ground based" input driving a single supply amplifier with ground acting as the "second" or "bottom" supply of the amplifier.

The Safe Operating Area (SOA) must be observed when determining the effect of all limits for the PA35 power op amp. Proper heat sinking is required for maximum reliability and performance.

TYPICAL CIRCUIT

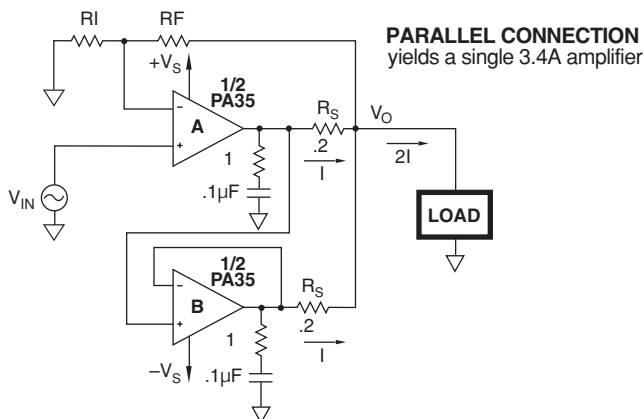

EXTERNAL CONNECTIONS PA35

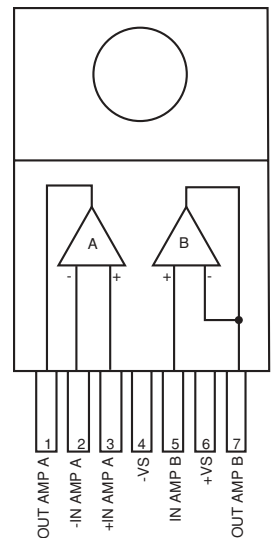

EQUIVALENT SCHEMATIC

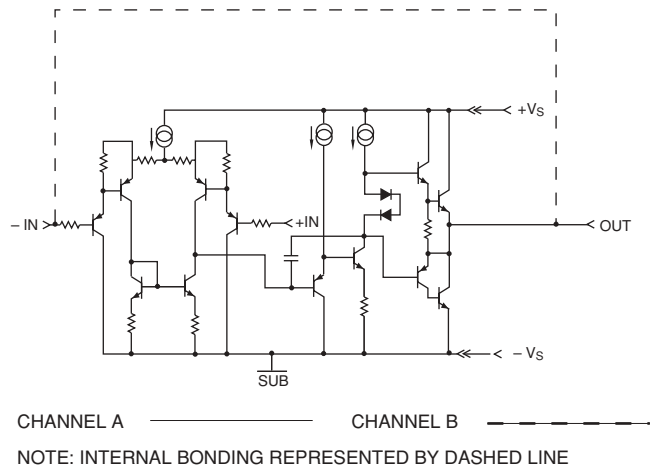

PA35

ABSOLUTE MAXIMUM RATINGS SPECIFICATIONS

ABSOLUTE MAXIMUM RATINGS

SUPPLY VOLTAGE, total	5V to 40V
OUTPUT CURRENT	1.7A
POWER DISSIPATION, internal, (per amplifier)	18.5W
POWER DISSIPATION, internal (both amplifiers)	27.5W
INPUT VOLTAGE, differential	$\pm V_S$
INPUT VOLTAGE, common mode	$+V_S, -V_S-5V$
JUNCTION TEMPERATURE, max ¹	150°C
TEMPERATURE, pin solder—10 sec max	300°C
TEMPERATURE RANGE, storage	-65°C to 150°C
OPERATING TEMPERATURE RANGE, case	-55°C to 125°C

SPECIFICATIONS

PARAMETER	TEST CONDITIONS ²	PA35			UNITS
		MIN	TYP	MAX	
INPUT					
OFFSET VOLTAGE, initial			1.5	10	mV
OFFSET VOLTAGE, vs. temperature	Full temperature range		15		$\mu V/^{\circ}C$
BIAS CURRENT, initial		35	1000	nA	
COMMON MODE RANGE	Full temperature range	$-V_S-3$		$+V_S-2$	dB
COMMON MODE REJECTION, DC	Full temperature range	60	85		dB
POWER SUPPLY REJECTION	Full temperature range	60	80		dB
GAIN					
OPEN LOOP GAIN	Full temperature range	80	100		dB
GAIN BANDWIDTH PRODUCT	$A_V = 40dB$		600		kHz
PHASE MARGIN	Full temperature range		65		$^{\circ}$
POWER BANDWIDTH	$V_{O(P-P)} = 28V$		13.6		kHz
OUTPUT					
CURRENT, peak		1.7			A
SLEW RATE		.5	1.2		V/ μs
CAPACITIVE LOAD DRIVE	$A_V = 1$.22		μF
VOLTAGE SWING	Full temp. range, $I_O = 100mA$	$ V_S - 1.0$	$ V_S - 0.8$		V
POWER SUPPLY					
VOLTAGE, V_{SS}^3		54	30	40	V
CURRENT, quiescent, total			45	90	mA
THERMAL					
RESISTANCE, DC junction to case (single)		5.44	6.80		$^{\circ}C/W$
RESISTANCE, AC junction to case (single)		4.07	5.10		$^{\circ}C/W$
RESISTANCE, DC junction to case (both)		3.64	4.55		
RESISTANCE, AC junction to case (both)		2.73	3.41		
RESISTANCE, junction to air				60	$^{\circ}C/W$
TEMPERATURE RANGE, case	Meets full range specifications	-25		85	$^{\circ}C$

NOTES:

1. Long term operation at the maximum junction temperature will result in reduced product life. Derate internal power dissipation to achieve high MTTF.
2. Unless otherwise noted, the following conditions apply: $\pm V_S = \pm 15V$, $T_C = 25^{\circ}C$.
3. $+V_S$ and $-V_S$ denote the positive and negative supply rail respectively. V_{SS} denotes the total rail-to-rail supply voltage.
4. Current limit may not function properly below $V_{SS} = 6V$, however SOA violations are unlikely in this area.

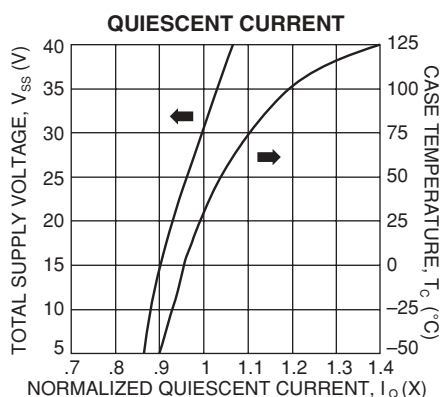
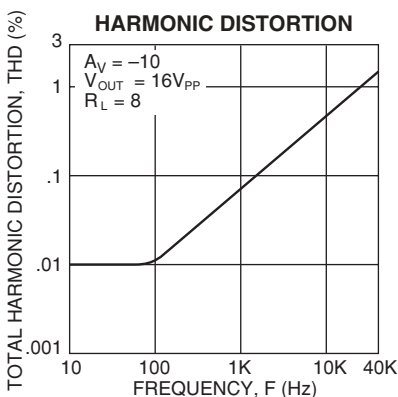
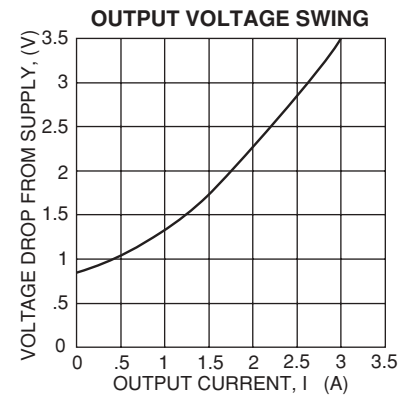
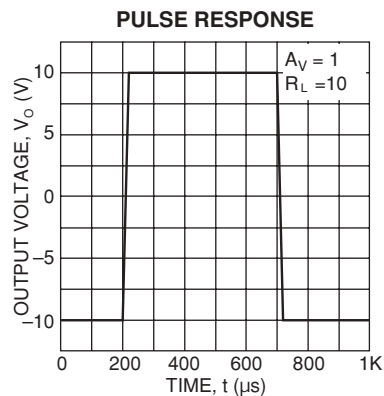
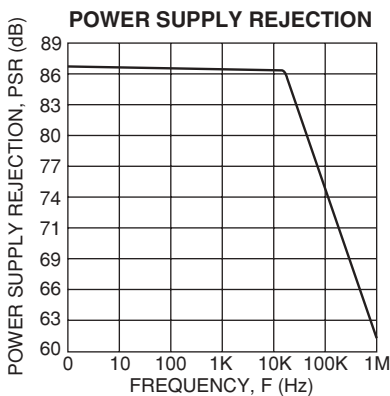
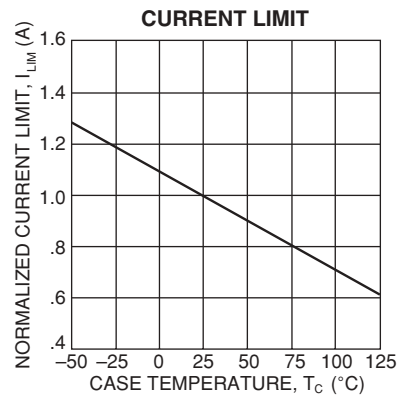
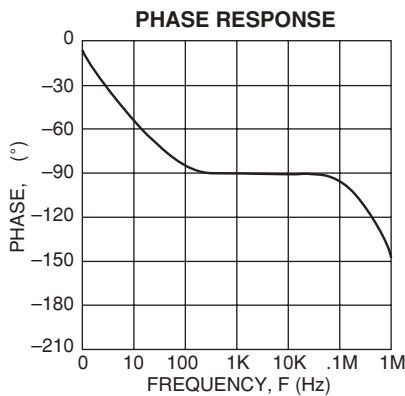
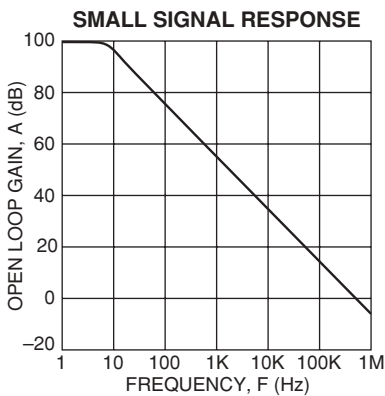
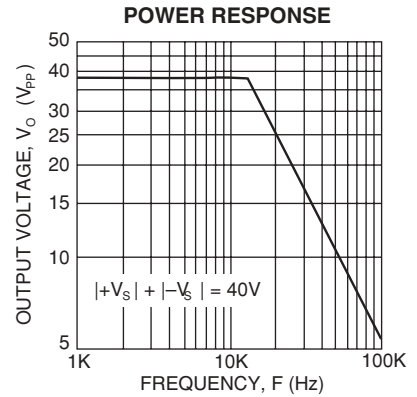
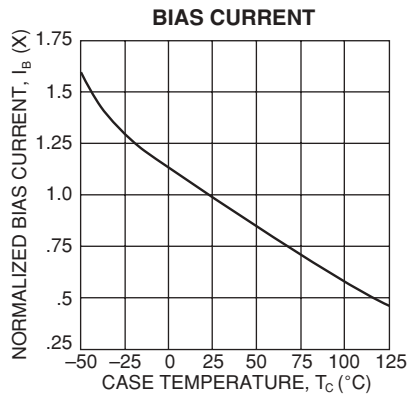
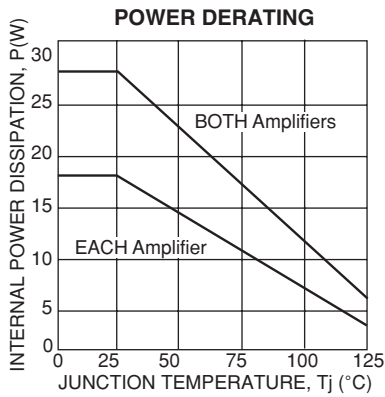

GENERAL

Please read Application Note 1 "General Operating Considerations" which covers stability, supplies, heat sinking, mounting, current limit, SOA interpretation, and specification interpretation. Visit www.apexmicrotech.com for design tools that help automate tasks such as calculations for stability, internal power dissipation, current limit and heat sink selection. The "Application Notes" and "Technical Seminar" sections contain a wealth of information on specific types of applications. Package outlines, heat sinks, mounting hardware and other accessories are located in the "Packages and Accessories" section. Evaluation Kits are available for most Apex product models, consult the "Evaluation Kit" section for details. For the most current version of all Apex product data sheets, visit www.apexmicrotech.com.

CURRENT LIMIT

Current limit is internal to the amplifier, the typical value is shown in the current limit specification.

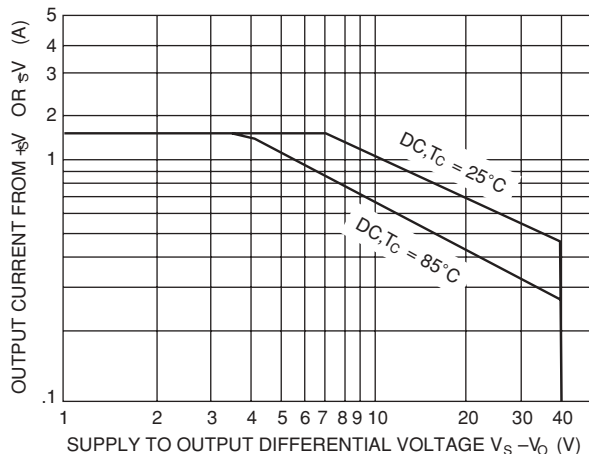

SAFE OPERATING AREA (SOA)

The SOA curves combine the effect of all limits for this power op amp. For a given application, the direction and magnitude of the output current should be calculated or measured and checked against the SOA curves. This is simple for resistive loads but more complex for reactive and EMF generating loads. The following guidelines may save extensive analytical efforts.

Under transient conditions, capacitive and dynamic* inductive loads up to the following maximum are safe:

$\pm V_s$	CAPACITIVE LOAD	INDUCTIVE LOAD
20V	200 μ F	7.5mH
15V	500 μ F	25mH
10V	5mF	35mH
5V	50mF	150mH

* If the inductive load is driven near steady state conditions,

allowing the output voltage to drop more than 6V below the supply rail while the amplifier is current limiting, the inductor should be capacitively coupled or the supply voltage must be lowered to meet SOA criteria.

NOTE: For protection against sustained, high energy flyback, external fast-recovery diodes should be used.

MONOLITHIC AMPLIFIER STABILITY CONSIDERATIONS

All monolithic power op amps use output stage topologies that present special stability problems. This is primarily due to non-complementary (both devices are NPN) output stages with a mismatch in gain and phase response for different polarities of output current. It is difficult for the op amp manufacturer to optimize compensation for all operating conditions.

The recommended R-C network of 1 ohm in series with 0.1 μ F from output to AC common (ground or a supply rail, with adequate bypass capacitors) will prevent local output stage oscillations.

The amplifiers are internally compensated for unity gain stability, no additional compensation is required.

THERMAL CONSIDERATIONS

The PA35 may require a thermal washer which is electrically insulating since the tab is tied to $-V_s$. This can result in thermal impedances for $R_{\theta CS}$ of up to 1 $^\circ\text{C}/\text{W}$ or greater.

V_{BIAS} should be set midway between $+V_s$ and $-V_s$, V_{ref} is usually ground in dual supply systems or used for level translation in single supply systems.

MOUNTING PRECAUTIONS

1. Always use a heat sink. Even unloaded, the PA35 can dissipate up to 3.6 watts. An insulating thermal washer should always be used.
2. Avoid bending the leads. Such action can lead to internal damage.
3. Always fasten the tab to the heat sink before the leads are soldered to fixed terminals.
4. Strain relief must be provided if there is any probability of axial stress to the leads.