

RAiO

RA8860

80x2 dots 16-Colors

LCD Driver

Specification

Version 1.1

October 14, 2010

1. Overview

The RA8860 is a LCD Driver & Controller for Field Sequential Liquid Crystal Display (FSLCD) systems. It contains 80 segment and 2 common driver circuits. This chip is connected directly to a MCU, support 3-wire, 4-wire serial peripheral interface (SPI) and I2C interface, display data can stores in an on-chip display data RAM of 640bits. It performs display data RAM read/write operation with no external operating clock to minimize power consumption. In addition, it also can produce LED driving signals to generate RGB LED backlight system if necessary.

2. Features

- ◆ 80Seg x 2Com Drive Outputs
- ◆ Supports Serial I²C, 3/4-wires MCU Interface
- ◆ Supports 8 or 16 Colors Display
- ◆ Build-in 640-bits Display RAM
- ◆ Duty: Static, 1/2 Duty
- ◆ Build-in Voltage Booster(4X) and Voltage Follower for LCD Driver
- ◆ Supports Blinking Mode
- ◆ Build-in RGB LED Driver for LED and Max. 80mA Sink Current for each Driver
- ◆ Build-in RC Oscillator
- ◆ Supports Multi FSLCD Drivers (Master / Slave Mode)
- ◆ Available package type: LQFP-128pin, Bare die
- ◆ Supply Voltage: 2.7~5.5V
- ◆ Ordering Information

Parts Number	Package Type
RA8860	Bare Die
RA8860L4N	LQFP-128pin

3. Block Diagram

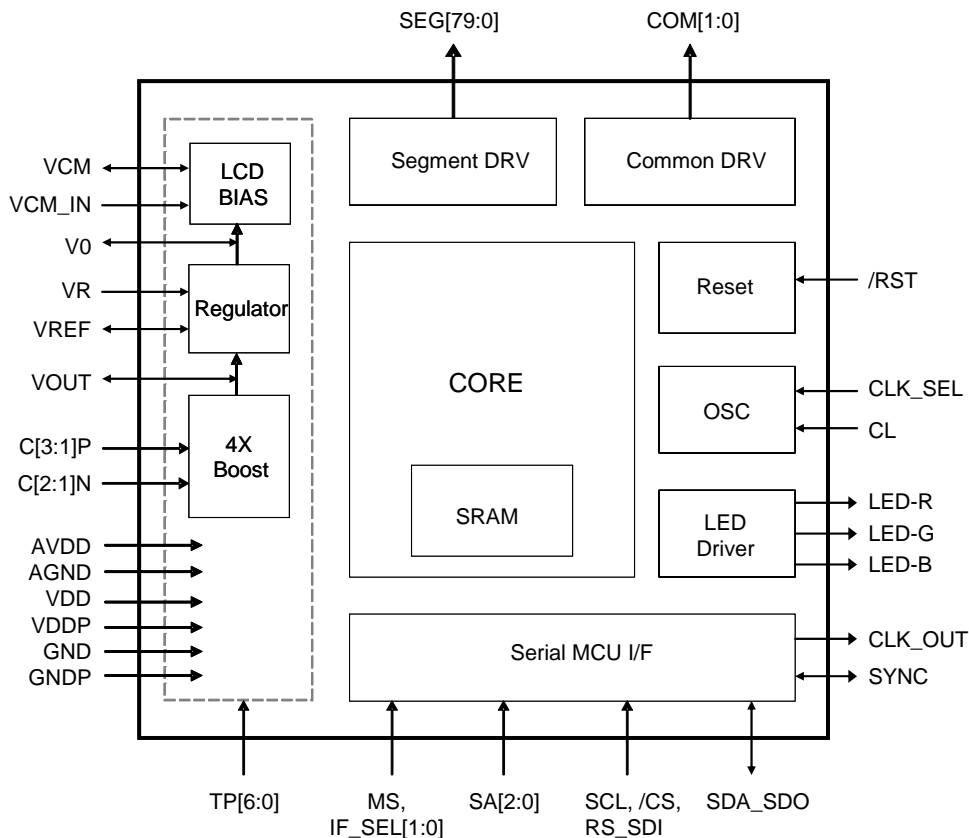

4. PAD Coordinate

Pad No.	Pad Name	X-axis	Y-axis
1	LED-R	-1836.585	-1210.29
2	LED-G	-1686.585	-1210.29
3	LED-B	-1556.145	-1210.29
4	GNDP	-1440.925	-1210.29
5	VDDP	-1250.925	-1274.97
6	SA2	-1150.925	-1274.97
7	SA1	-1050.925	-1274.97
8	SA0	-950.925	-1274.97
9	MS	-850.925	-1274.97
10	SCL	-750.925	-1274.97
11	/CS	-650.925	-1274.97
12	SDA_SDO	-550.925	-1274.97
13	RS_SDI	-450.925	-1274.97
14	IF_SEL1	-350.925	-1274.97
15	IF_SEL0	-250.925	-1274.97
16	SYNC	-150.925	-1274.97
17	CLK_OUT	-50.925	-1274.97
18	CL	49.075	-1274.97
19	CLK_SEL	149.075	-1274.97
20	/RST	249.075	-1274.97
21	VDD	349.075	-1274.97
22	GND	449.075	-1274.97
23	GNDP	549.075	-1274.97
24	AGND	649.075	-1274.97
25	AVDD	749.075	-1274.97
26	C2N	849.075	-1274.97
27	C2P	970.315	-1260.87
28	C1P	1070.315	-1260.87
29	C1N	1191.555	-1267.97
30	C3P	1312.795	-1260.87
31	VOOUT	1412.795	-1260.87
32	VR	1512.795	-1260.87
33	V0	1612.795	-1260.87
34	VCM_IN	1722.795	-1260.87
35	VCM	1847.795	-1260.87
36	VREF	1997.795	-1274.97
37	TP0	2099.7	-1226.8
38	TP1	2133.0	-1184.0
39	TP2	2099.7	-1141.2
40	TP3	2133.0	-1098.4
41	TP4	2099.7	-1055.6
42	TP5	2133.0	-1012.8
43	TP6	2099.7	-970.0
44	SEG0	2113.0	-900.0

Pad No.	Pad Name	X-axis	Y-axis
45	SEG1	2113.0	-800.0
46	SEG2	2113.0	-700.0
47	SEG3	2113.0	-600.0
48	SEG4	2113.0	-500.0
49	SEG5	2113.0	-400.0
50	SEG6	2113.0	-300.0
51	SEG7	2113.0	-200.0
52	SEG8	2113.0	-100.0
53	SEG9	2113.0	0.0
54	SEG10	2113.0	100.0
55	SEG11	2113.0	200.0
56	SEG12	2113.0	300.0
57	SEG13	2113.0	400.0
58	SEG14	2113.0	500.0
59	SEG15	2113.0	600.0
60	SEG16	2113.0	700.0
61	SEG17	2113.0	800.0
62	SEG18	2113.0	900.0
63	SEG19	2113.0	1010.0
64	SEG20	2113.0	1135.0
65	SEG21	2113.0	1285.0
66	SEG22	1785.0	1350.0
67	SEG23	1635.0	1350.0
68	SEG24	1510.0	1350.0
69	SEG25	1400.0	1350.0
70	SEG26	1300.0	1350.0
71	SEG27	1200.0	1350.0
72	SEG28	1100.0	1350.0
73	SEG29	1000.0	1350.0
74	SEG30	900.0	1350.0
75	SEG31	800.0	1350.0
76	SEG32	700.0	1350.0
77	SEG33	600.0	1350.0
78	SEG34	500.0	1350.0
79	SEG35	400.0	1350.0
80	SEG36	300.0	1350.0
81	SEG37	200.0	1350.0
82	SEG38	100.0	1350.0
83	SEG39	0.0	1350.0
84	SEG40	-100.0	1350.0
85	SEG41	-200.0	1350.0
86	SEG42	-300.0	1350.0
87	SEG43	-400.0	1350.0
88	SEG44	-500.0	1350.0

Pad No.	Pad Name	X-axis	Y-axis
89	SEG45	-600.0	1350.0
90	SEG46	-700.0	1350.0
91	SEG47	-800.0	1350.0
92	SEG48	-900.0	1350.0
93	SEG49	-1000.0	1350.0
94	SEG50	-1100.0	1350.0
95	SEG51	-1200.0	1350.0
96	SEG52	-1300.0	1350.0
97	SEG53	-1400.0	1350.0
98	SEG54	-1510.0	1350.0
99	SEG55	-1635.0	1350.0
100	SEG56	-1785.0	1350.0
101	SEG57	-2113.0	1285.0
102	SEG58	-2113.0	1135.0
103	SEG59	-2113.0	1010.0
104	SEG60	-2113.0	900.0
105	SEG61	-2113.0	800.0
106	SEG62	-2113.0	700.0
107	SEG63	-2113.0	600.0

Pad No.	Pad Name	X-axis	Y-axis
108	SEG64	-2113.0	500.0
109	SEG65	-2113.0	400.0
110	SEG66	-2113.0	300.0
111	SEG67	-2113.0	200.0
112	SEG68	-2113.0	100.0
113	SEG69	-2113.0	0.0
114	SEG70	-2113.0	-100.0
115	SEG71	-2113.0	-200.0
116	SEG72	-2113.0	-300.0
117	SEG73	-2113.0	-400.0
118	SEG74	-2113.0	-500.0
119	SEG75	-2113.0	-600.0
120	SEG76	-2113.0	-700.0
121	SEG77	-2113.0	-800.0
122	SEG78	-2113.0	-900.0
123	SEG79	-2113.0	-1010.0
124	COM0	-2113.0	-1135.0
125	COM1	-2113.0	-1285.0

5. Pin Diagram

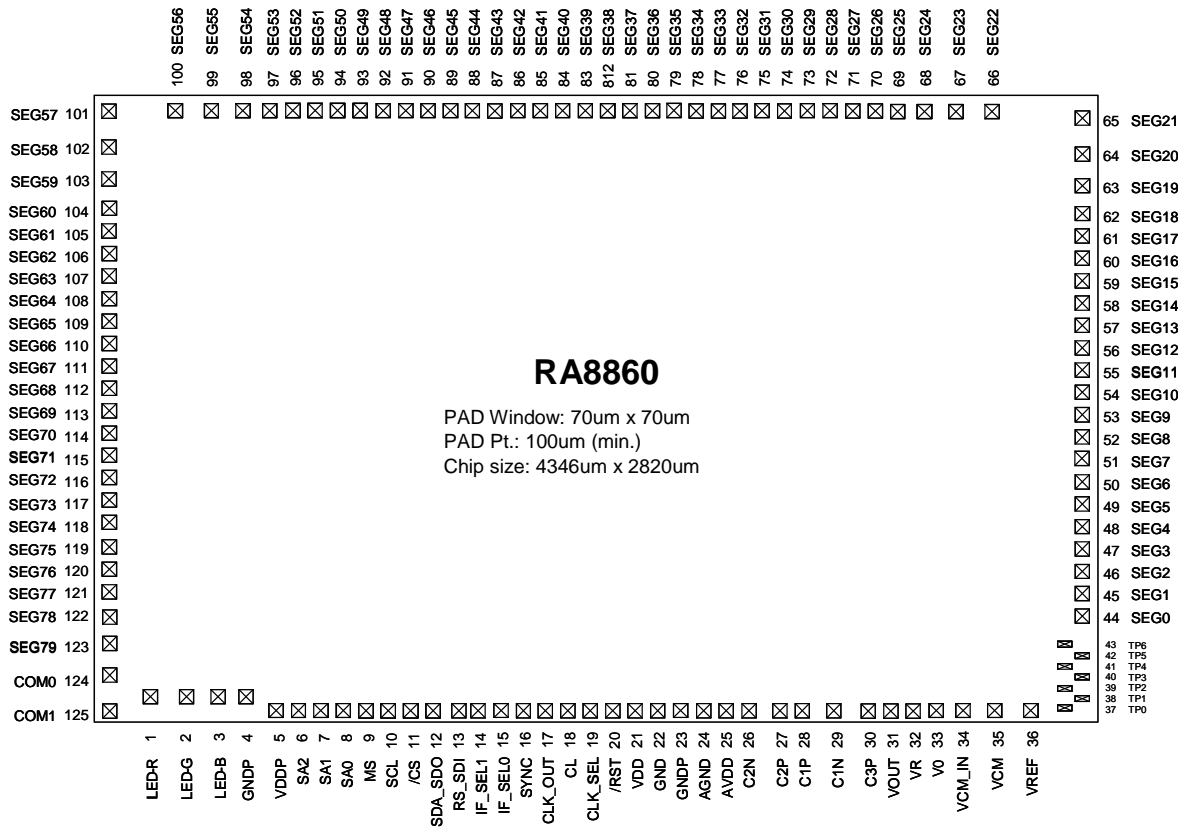

6. Block Diagram

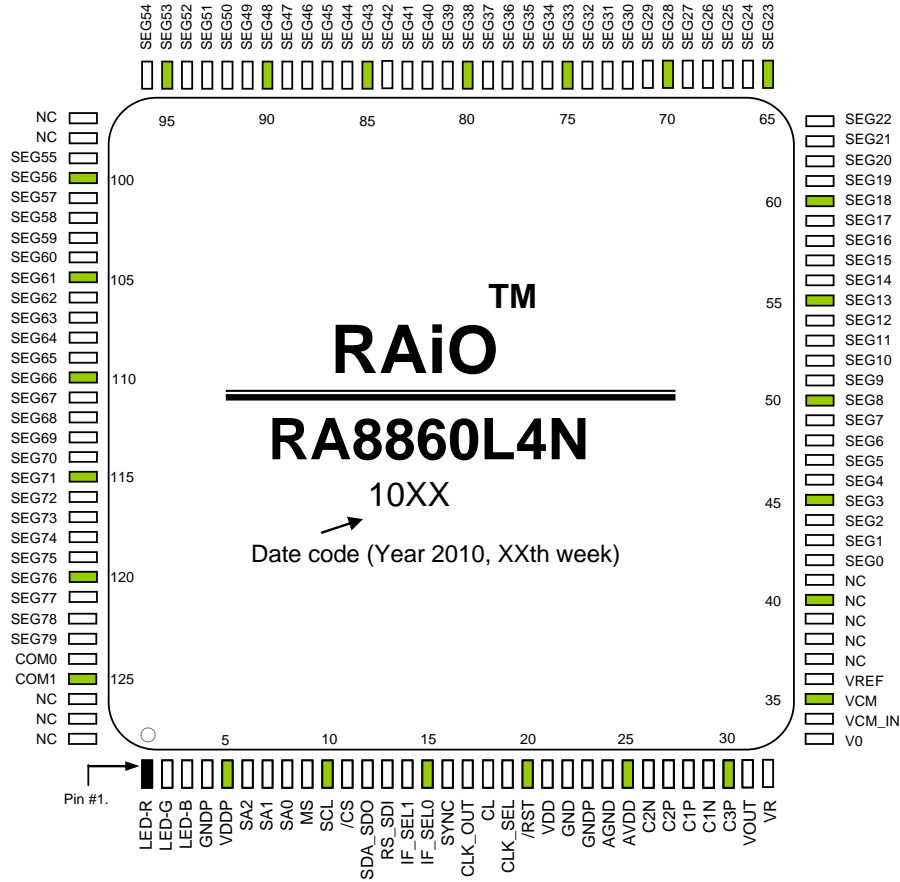

7. Application Circuit

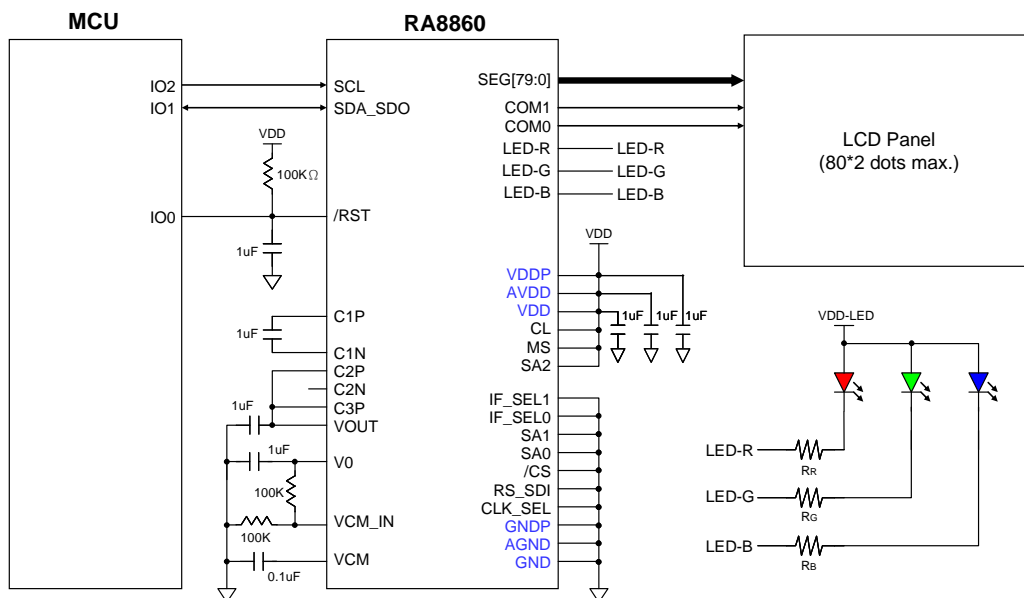







8. Pin Description









Pin Name	I/O	Description
LCD Driver Outputs		
SEG[79:0]	O	LCD Segment Driver Outputs.
COM[1:0]	O	LCD Common Driver Outputs.
LED Driver Outputs		
LED-R	O	Red LED pulse signal output.
LED-G	O	Green LED pulse signal output.
LED-B	O	Blue LED pulse signal output.
MCU Interface		
/RST	I	Reset Pin.
IF_SEL[1:0]	I	Serial MCU Interface Select. 00 : I ² C. 01 : 3-wires SPI. 10 : 4-wires SPI Type-A. 11 : 4-wires SPI Type-B.
SCL, /CS	I	Serial Data Interface. In serial mode, all of the related signals are defined as below: SCL : Serial Clock. SDA : Bi-direction Serial Data. SDO : Serial Data Out. RS : Memory/Register Cycle Select. SDI : Serial Data In.
SDA_SDO	I/O	
RS_SDI	I	
CLK_SEL	I	Clock Select. 0 : Clock source is from internal RC oscillator. 1 : Clock source is from external pin – "CL".
CL	I	External Clock Input. When CLK_SEL=1 or Slave mode, this pin is used as external clock input. If not used, please connect to VDDP or GND.
MS	I	Master / Slave Mode Select. 0 : Slave Mode 1 : Master Mode
SA[2:0]	I	Device address select of I ² C interface. If not used, please connect to VDDP or GND.
SYNC	I/O	Synchronous Pin for Multi-Chips Using. When MS=1, this pin is output. When MS=0, this pin is input.
CLK_OUT	O	System Clock Output.
Power Supply		
VDD, GND	P	Core Power.
AVDD, AGND	P	Analog Power for LCD.
VDDP, GNDP	P	I/O Power.
C[3:1]P C[2:1]N	O	External capacitor pins for boost circuit.
VOOUT	P	Boost Power Output.
VREF	P	Reference Voltage for V0.
VR	I	For using of External R2/R1.
V0 VCM_IN VCM	P	LCD Driver Voltage.
TP[6:0]	I	Test Pins. These pins must keep NC in normal mode.

9. Color Table















8-Colors Table (Normally White)

Data	Color	
000	White	
001	Yellow	
010	Pink	
011	Red	
100	Cyan	
101	Green	
110	Blue	
111	Black	

8-Colors Table (Normally Black)

Data	Color	
111	White	
110	Yellow	
101	Pink	
100	Red	
011	Cyan	
010	Green	
001	Blue	
000	Black	

16-Colors Table (Normally White)

Data	Color		Data	Color	
0000	White		1000	Maroon	
0001	Yellow		1001	Aqua	
0010	Pink		1010	Lime Green	
0011	Red		1011	Teal	
0100	Purplish Red		1100	Green	
0101	Light Green		1101	Blue	
0110	Orange		1110	Navy Blue	
0111	Purple		1111	Black	