

# AUIRF7379Q

HEXFET® Power MOSFET

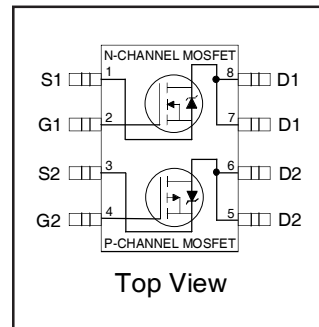
## Features

- Advanced Planar Technology
- Low On-Resistance
- Dual N and P Channel MOSFET
- Surface Mount
- Available in Tape & Reel
- 150°C Operating Temperature
- Automotive [Q101] Qualified
- Lead-Free, RoHS Compliant

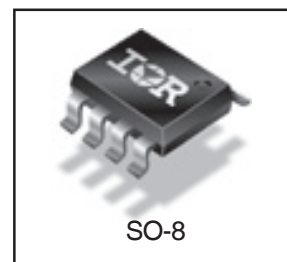
## Description

Specifically designed for Automotive applications, these HEXFET® Power MOSFET's in a Dual SO-8 package utilize the latest processing techniques to achieve extremely low on-resistance per silicon area. Additional features of these Automotive qualified HEXFET Power MOSFET's are a 150°C junction operating temperature, fast switching speed and improved repetitive avalanche rating. These benefits combine to make this design an extremely efficient and reliable device for use in Automotive applications and a wide variety of other applications.

The efficient SO-8 package provides enhanced thermal characteristics and dual MOSFET die capability making it ideal in a variety of power applications. This dual, surface mount SO-8 can dramatically reduce board space and is also available in Tape & Reel.



	N-Ch	P-Ch
$V_{(BR)DSS}$	30V	-30V
$R_{DS(on)}$ typ.	0.038Ω	0.070Ω
	max.	0.045Ω
$I_D$	5.8A	-4.3A



G	D	S
Gate	Drain	Source

## Absolute Maximum Ratings

Stresses beyond those listed under "Absolute Maximum Ratings" may cause permanent damage to the device. These are stress ratings only; and functional operation of the device at these or any other condition beyond those indicated in the specifications is not implied. Exposure to absolute-maximum-rated conditions for extended periods may affect device reliability. The thermal resistance and power dissipation ratings are measured under board mounted and still air conditions. Ambient temperature ( $T_A$ ) is 25°C, unless otherwise specified.

	Parameter	Max.		Units
		N-Channel	P-Channel	
$V_{DS}$	Drain-Source Voltage	30	-30	V
$I_D @ T_A = 25^\circ\text{C}$	Continuous Drain Current, $V_{GS} @ 10\text{V}$	5.8	-4.3	A
$I_D @ T_A = 70^\circ\text{C}$	Continuous Drain Current, $V_{GS} @ 10\text{V}$	4.6	-3.4	
$I_{DM}$	Pulsed Drain Current ①	46	-34	
$P_D @ T_A = 25^\circ\text{C}$	Power Dissipation	2.5		W
	Linear Derating Factor	0.02		
$V_{GS}$	Gate-to-Source Voltage	± 20		V
dv/dt	Peak Diode Recovery dv/dt ②	5.0	-5.0	V/ns
$T_J$ $T_{STG}$	Operating Junction and Storage Temperature Range	-55 to + 150		°C

## Thermal Resistance

	Parameter	Typ.	Max.	Units
$R_{\theta JA}$	Junction-to-Ambient ④	—	50	°C/W

HEXFET® is a registered trademark of International Rectifier.

\*Qualification standards can be found at <http://www.irf.com/>

## Static Electrical Characteristics @ T<sub>J</sub> = 25°C (unless otherwise stated)

Parameter	Parameter		Min.	Typ.	Max.	Units	Conditions
V <sub>(BR)DSS</sub>	Drain-to-Source Breakdown Voltage	N-Ch	30	—	—	V	V <sub>GS</sub> = 0V, I <sub>D</sub> = 250μA
		P-Ch	-30	—	—		V <sub>GS</sub> = 0V, I <sub>D</sub> = -250μA
ΔV <sub>(BR)DSS</sub> /ΔT <sub>J</sub>	Breakdown Voltage Temp. Coefficient	N-Ch	—	0.032	—	V/°C	Reference to 25°C, I <sub>D</sub> = 1mA
		P-Ch	—	-0.037	—		Reference to 25°C, I <sub>D</sub> = -1mA
R <sub>DS(on)</sub>	Static Drain-to-Source On-Resistance	N-Ch	—	0.038	0.045	Ω	V <sub>GS</sub> = 10V, I <sub>D</sub> = 5.8A ③
			—	0.055	0.075		V <sub>GS</sub> = 4.5V, I <sub>D</sub> = 4.9A ③
		P-Ch	—	0.070	0.090		V <sub>GS</sub> = -10V, I <sub>D</sub> = -4.3A ③
			—	0.130	0.180		V <sub>GS</sub> = -4.5V, I <sub>D</sub> = -3.7A ③
V <sub>GS(th)</sub>	Gate Threshold Voltage	N-Ch	1.0	—	3.0	V	V <sub>DS</sub> = V <sub>GS</sub> , I <sub>D</sub> = 250μA
		P-Ch	-1.0	—	-3.0		V <sub>DS</sub> = V <sub>GS</sub> , I <sub>D</sub> = -250μA
g <sub>fs</sub>	Forward Transconductance	N-Ch	5.2	—	—	S	V <sub>DS</sub> = 15V, I <sub>D</sub> = 2.4A ③
		P-Ch	2.5	—	—		V <sub>DS</sub> = -24V, I <sub>D</sub> = -1.8A ③
I <sub>DSS</sub>	Drain-to-Source Leakage Current	N-Ch	—	—	1.0	μA	V <sub>DS</sub> = 24V, V <sub>GS</sub> = 0V
		P-Ch	—	—	-1.0		V <sub>DS</sub> = -24V, V <sub>GS</sub> = 0V
		N-Ch	—	—	25		V <sub>DS</sub> = 24V, V <sub>GS</sub> = 0V, T <sub>J</sub> = 125°C
		P-Ch	—	—	-25		V <sub>DS</sub> = -24V, V <sub>GS</sub> = 0V, T <sub>J</sub> = 125°C
I <sub>GSS</sub>	Gate-to-Source Forward Leakage		—	—	± 100	nA	V <sub>GS</sub> = ± 20V

## Dynamic Electrical Characteristics @ T<sub>J</sub> = 25°C (unless otherwise stated)

Parameter	Parameter		Min.	Typ.	Max.	Units	Conditions
Q <sub>g</sub>	Total Gate Charge	N-Ch	—	—	25	nC	N-Channel I <sub>D</sub> = 2.4A V <sub>DS</sub> = 24V, V <sub>GS</sub> = 10V
		P-Ch	—	—	25		
Q <sub>gs</sub>	Gate-to-Source Charge	N-Ch	—	—	2.9	nC	P-Channel ③
		P-Ch	—	—	2.9		
Q <sub>gd</sub>	Gate-to-Drain ("Miller") Charge	N-Ch	—	—	7.9	nC	I <sub>D</sub> = -1.8A V <sub>DS</sub> = -24V, V <sub>GS</sub> = -10V
		P-Ch	—	—	9.0		
t <sub>d(on)</sub>	Turn-On Delay Time	N-Ch	—	6.8	—	ns	N-Channel V <sub>DD</sub> = 15V, I <sub>D</sub> = 2.4A, R <sub>G</sub> = 6.0Ω R <sub>D</sub> = 6.2Ω
		P-Ch	—	11	—		
t <sub>r</sub>	Rise Time	N-Ch	—	21	—	ns	P-Channel ③
		P-Ch	—	17	—		
t <sub>d(off)</sub>	Turn-Off Delay Time	N-Ch	—	22	—	ns	V <sub>DD</sub> = -15V, I <sub>D</sub> = -1.8A, R <sub>G</sub> = 6.0Ω R <sub>D</sub> = 8.2Ω
		P-Ch	—	25	—		
t <sub>f</sub>	Fall Time	N-Ch	—	7.7	—	ns	
		P-Ch	—	18	—		
L <sub>D</sub>	Internal Drain Inductance	N-P	—	4.0	—	nH	Between lead, 6mm (0.25in.) from package and center of die contact
L <sub>S</sub>	Internal Source Inductance	N-P	—	6.0	—		
C <sub>iss</sub>	Input Capacitance	N-Ch	—	520	—	pF	N-Channel V <sub>GS</sub> = 0V, V <sub>DS</sub> = 25V, f = 1.0Mhz
		P-Ch	—	440	—		
C <sub>oss</sub>	Output Capacitance	N-Ch	—	180	—	pF	P-Channel V <sub>GS</sub> = 0V, V <sub>DS</sub> = -25V, f = 1.0Mhz
		P-Ch	—	200	—		
C <sub>rss</sub>	Reverse Transfer Capacitance	N-Ch	—	72	—	pF	
		P-Ch	—	93	—		

## Diode Characteristics

Parameter	Parameter		Min.	Typ.	Max.	Units	Conditions
I <sub>S</sub>	Continuous Source Current (Body Diode)	N-Ch	—	—	3.1	A	
		P-Ch	—	—	-3.1		
I <sub>SM</sub>	Pulsed Source Current (Body Diode) ①	N-Ch	—	—	46	A	
		P-Ch	—	—	-34		
V <sub>SD</sub>	Diode Forward Voltage	N-Ch	—	—	1.0	V	T <sub>J</sub> = 25°C, I <sub>S</sub> = 1.8A, V <sub>GS</sub> = 0V ③
		P-Ch	—	—	-1.0		T <sub>J</sub> = 25°C, I <sub>S</sub> = -1.8A, V <sub>GS</sub> = 0V ③
t <sub>rr</sub>	Reverse Recovery Time	N-Ch	—	47	71	ns	N-Channel T <sub>J</sub> = 25°C, I <sub>F</sub> = 2.4A di/dt = 100A/μs
		P-Ch	—	53	80		
Q <sub>rr</sub>	Reverse Recovery Charge	N-Ch	—	56	84	nC	P-Channel ③ T <sub>J</sub> = 25°C, I <sub>F</sub> = -1.8A di/dt = 100A/μs
		P-Ch	—	66	99		

Notes ① through ④ are on page 10

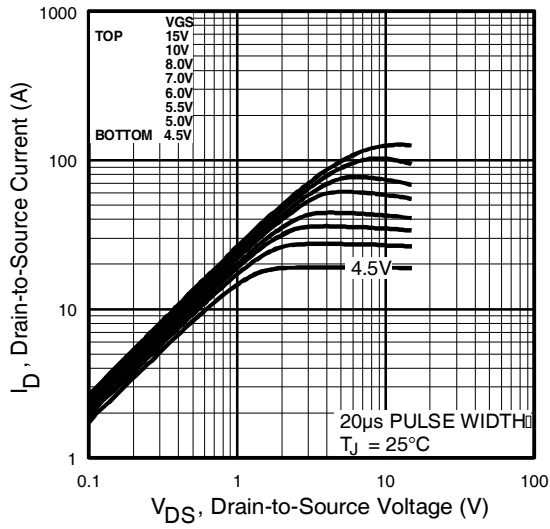
## Qualification Information<sup>†</sup>

<b>Qualification Level</b>		Automotive (per AEC-Q101) <sup>††</sup>	
		Comments: This part number(s) passed Automotive qualification. IR's Industrial and Consumer qualification level is granted by extension of the higher Automotive level.	
<b>Moisture Sensitivity Level</b>		SO-8	MSL1
<b>ESD</b>	Machine Model	N Ch: Class M2(+/- 150V) <sup>†††</sup> (per AEC-Q101-002)	P Ch: Class M2(+/- 150V) <sup>†††</sup>
	Human Body Model	N Ch : Class H1A(+/- 500V) <sup>†††</sup> (per AEC-Q101-001)	P Ch: Class H0(+/- 250V) <sup>†††</sup>
	Charged Device Model	N Ch: Class C5(+/- 2000V) <sup>†††</sup> (per AEC-Q101-005)	P Ch: Class C5(+/- 2000V) <sup>†††</sup>
<b>RoHS Compliant</b>		Yes	

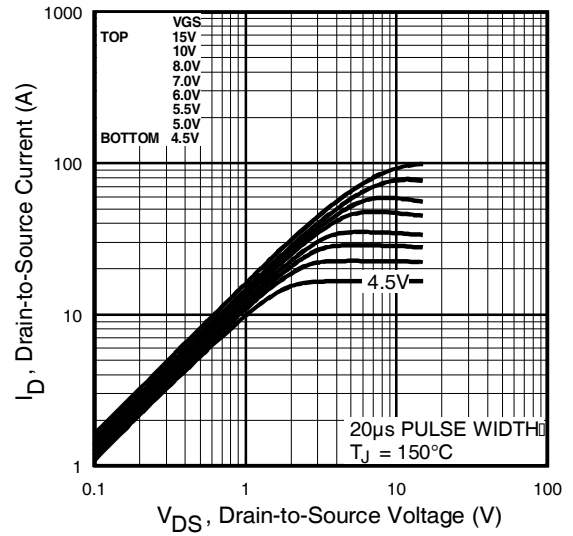
† Qualification standards can be found at International Rectifier's web site: <http://www.irf.com/>

†† Exceptions (if any) to AEC-Q101 requirements are noted in the qualification report.

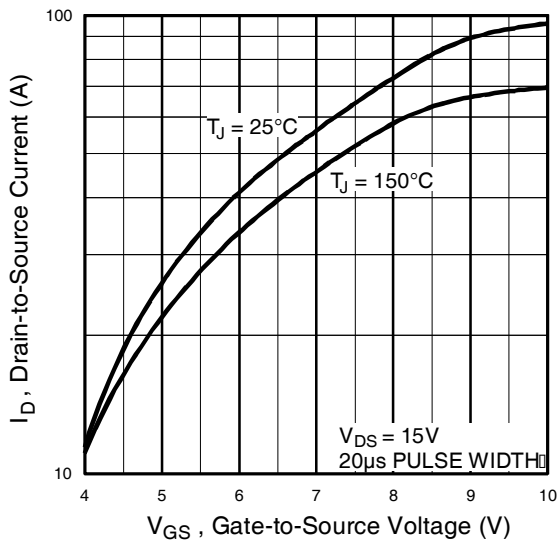
††† Highest passing voltage



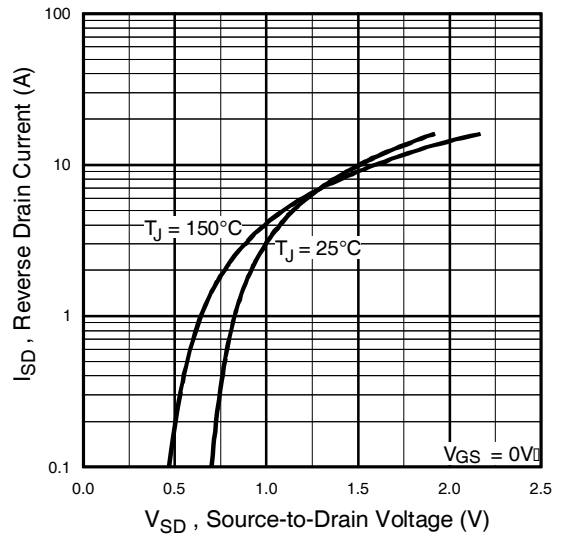
**Fig 1.** Typical Output Characteristics



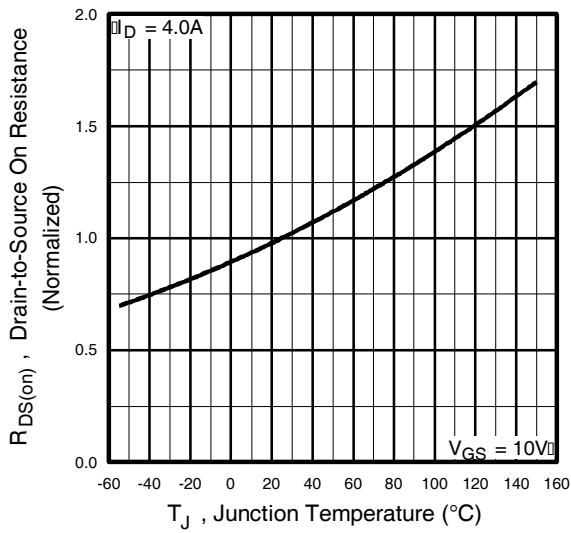
**Fig 2.** Typical Output Characteristics



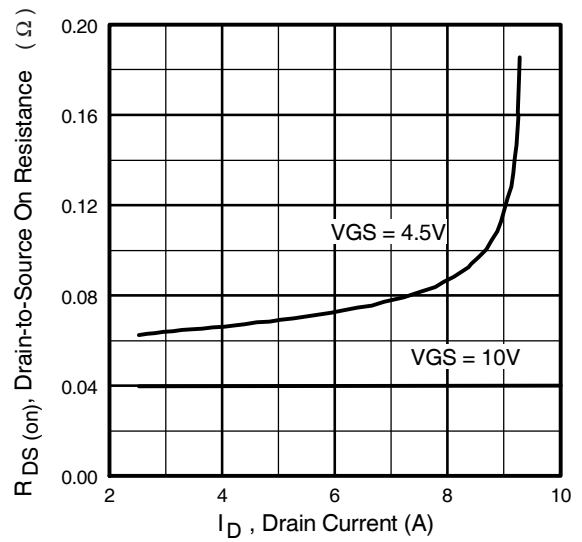
**Fig 3.** Typical Transfer Characteristics



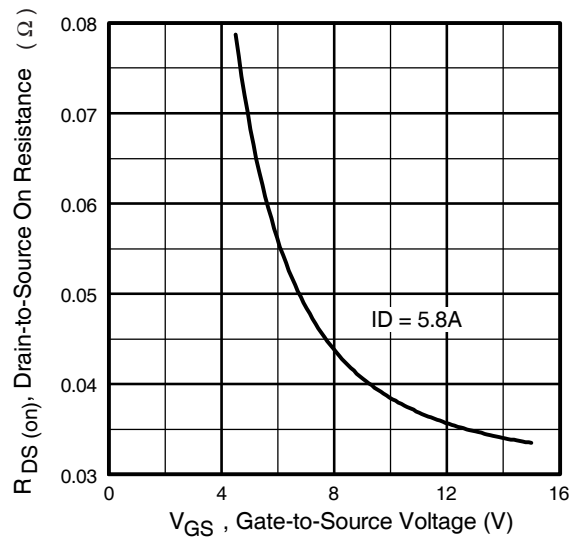
**Fig 4.** Typical Source-Drain Diode Forward Voltage



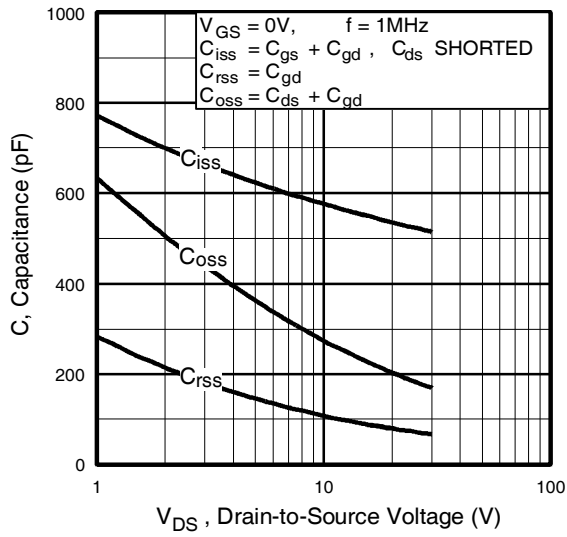
**Fig 5.** Normalized On-Resistance Vs. Temperature



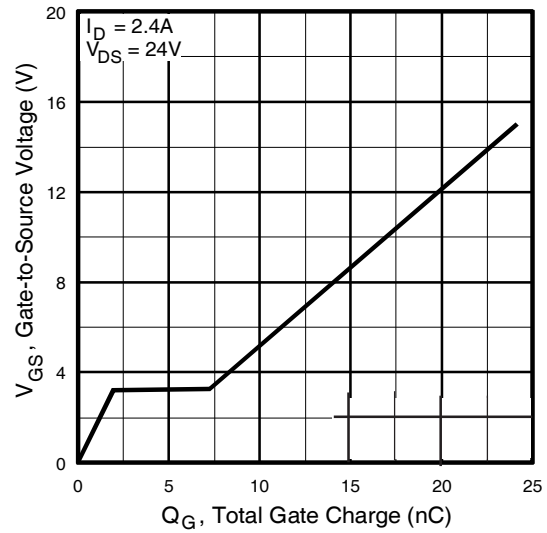
**Fig 6.** Typical On-Resistance Vs. Drain Current



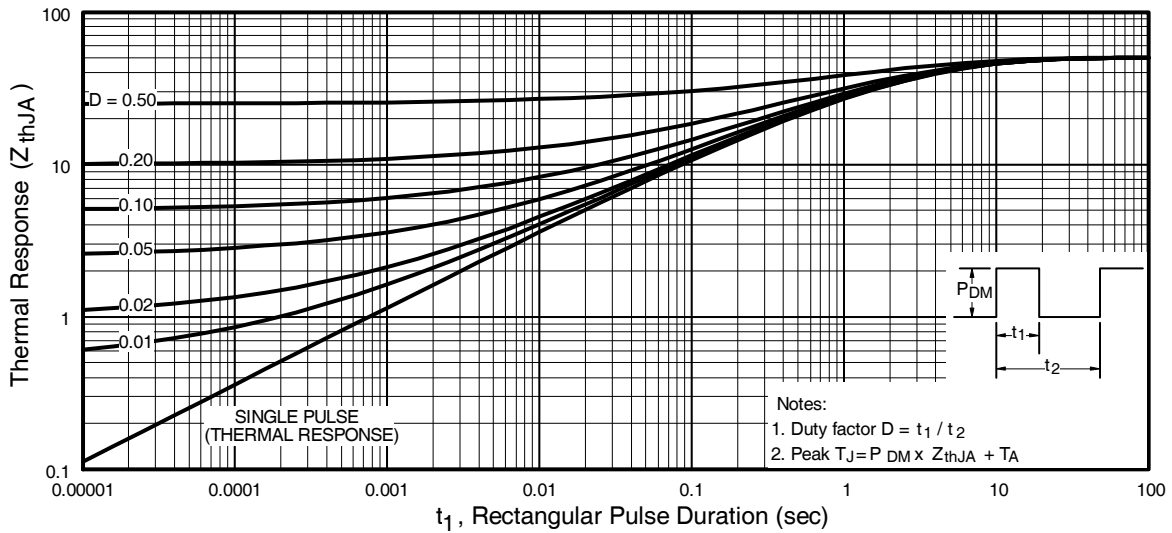
**Fig 7.** Typical On-Resistance Vs. Gate Voltage



**Fig 8.** Typical Capacitance Vs. Drain-to-Source Voltage



**Fig 9.** Typical Gate Charge Vs. Gate-to-Source Voltage



**Fig 10.** Maximum Effective Transient Thermal Impedance, Junction-to-Ambient

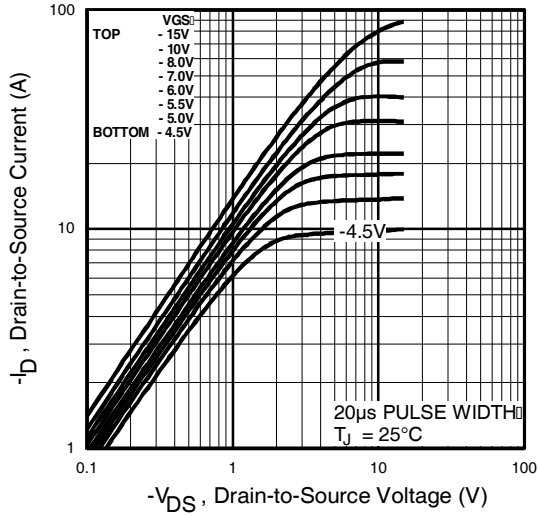


Fig 11. Typical Output Characteristics

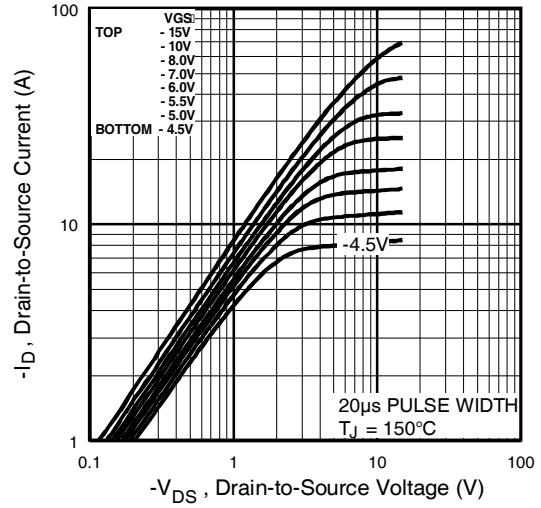


Fig 12. Typical Output Characteristics

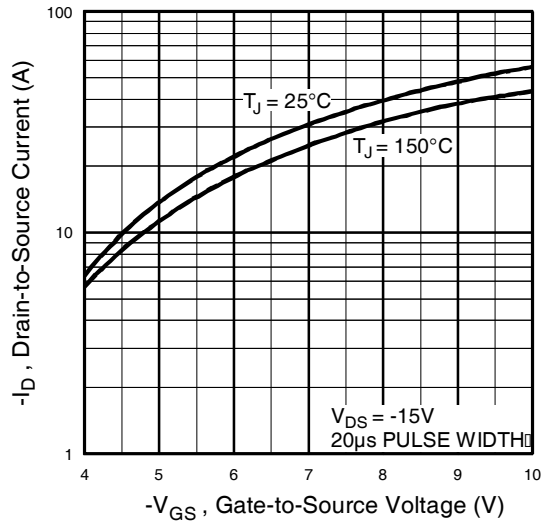


Fig 13. Typical Transfer Characteristics

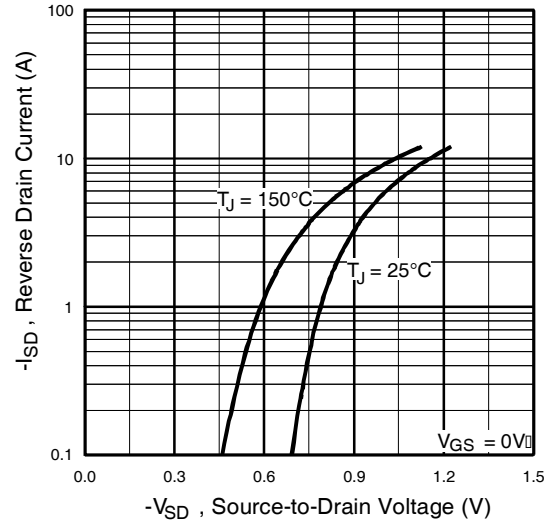
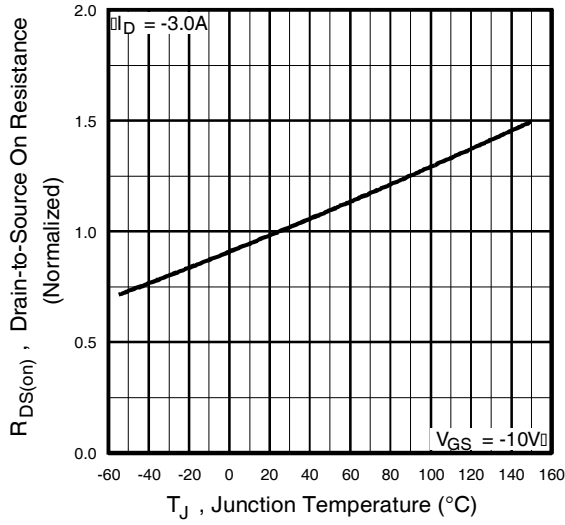
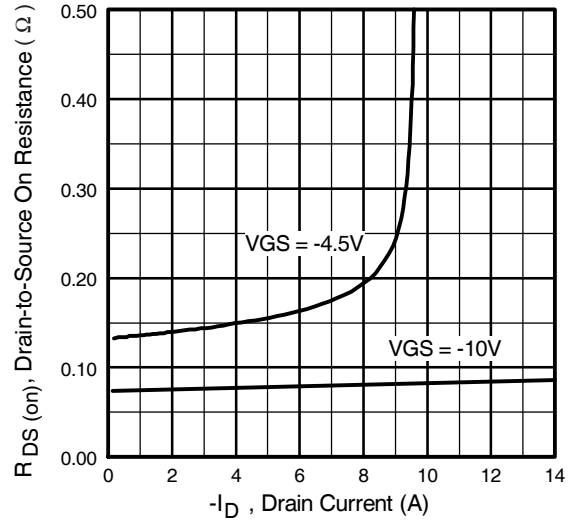


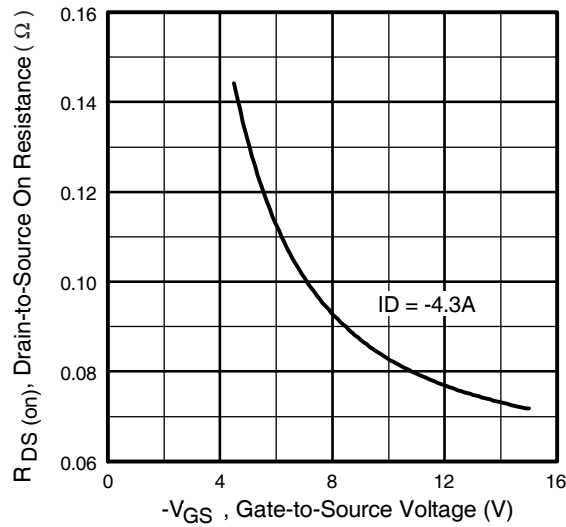
Fig 14. Typical Source-Drain Diode Forward Voltage



**Fig 15.** Normalized On-Resistance Vs. Temperature

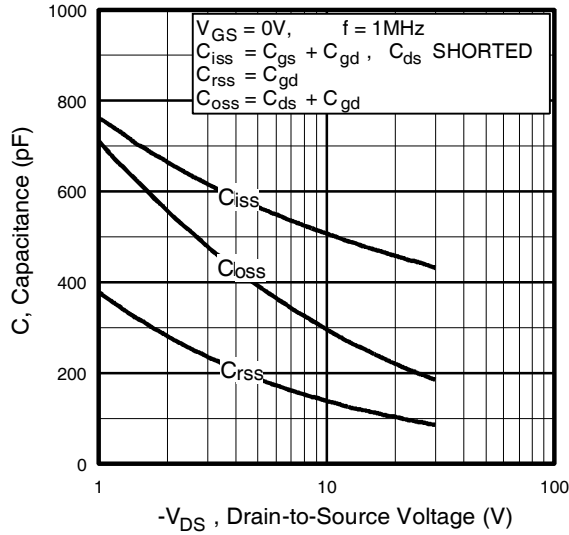


**Fig 16.** Typical On-Resistance Vs. Drain Current

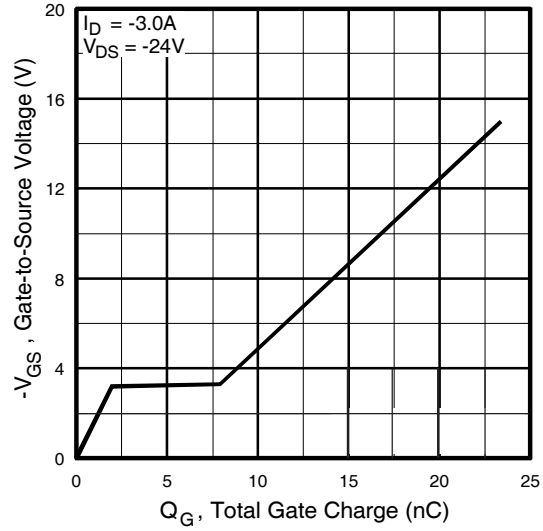


**Fig 17.** Typical On-Resistance Vs. Gate Voltage

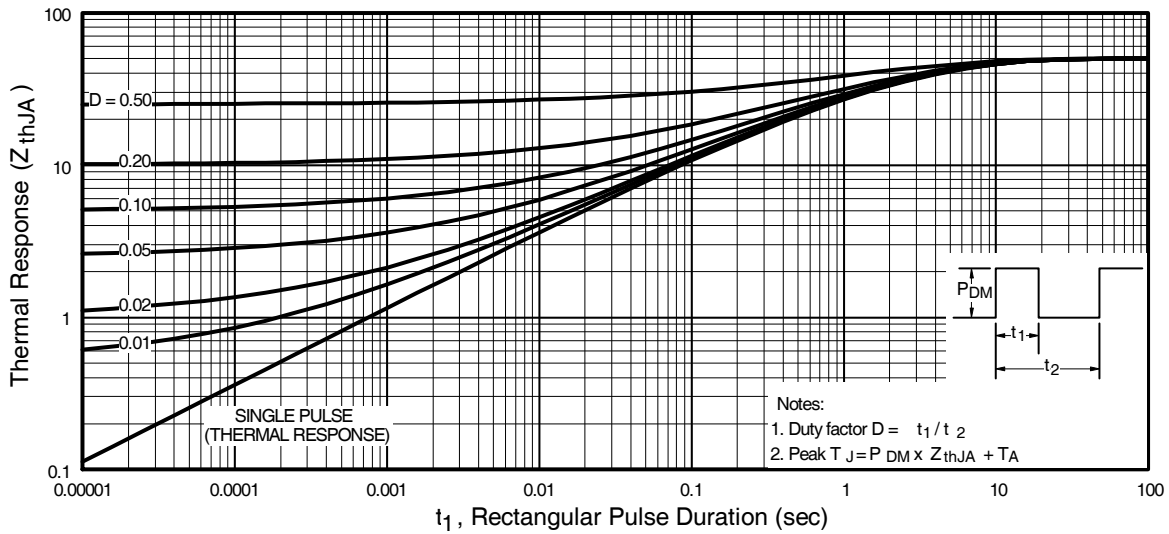




**Fig 18.** Typical Capacitance Vs. Drain-to-Source Voltage



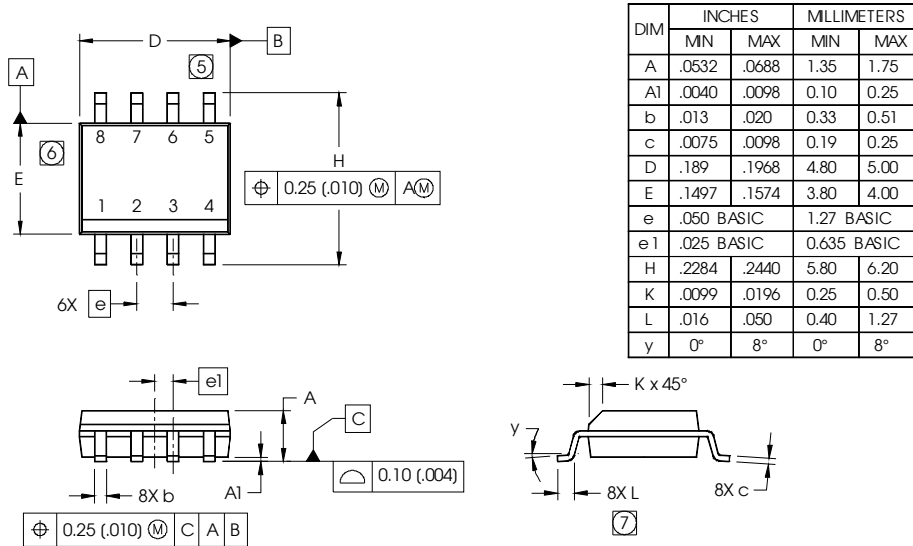
**Fig 19.** Typical Gate Charge Vs. Gate-to-Source Voltage



**Fig 20.** Maximum Effective Transient Thermal Impedance, Junction-to-Ambient

## SO-8 Package Outline

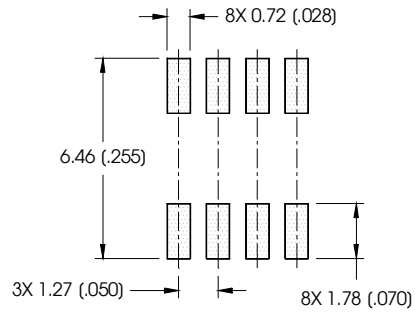
Dimensions are shown in millimeters (inches)



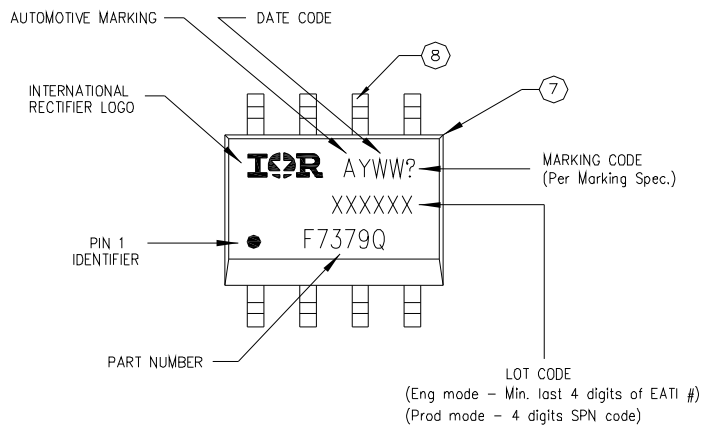
**NOTES:**

1. DIMENSIONING & TOLERANCING PER ASME Y14.5M-1994.
2. CONTROLLING DIMENSION: MILLIMETER
3. DIMENSIONS ARE SHOWN IN MILLIMETERS (INCHES).
4. OUTLINE CONFORMS TO JEDEC OUTLINE MS-012AA.
5. DIMENSION DOES NOT INCLUDE MOLD PROTRUSIONS. MOLD PROTRUSIONS NOT TO EXCEED 0.15 (.006).
6. DIMENSION DOES NOT INCLUDE MOLD PROTRUSIONS. MOLD PROTRUSIONS NOT TO EXCEED 0.25 (.010).
7. DIMENSION IS THE LENGTH OF LEAD FOR SOLDERING TO A SUBSTRATE.

**FOOTPRINT**



## SO-8 Part Marking

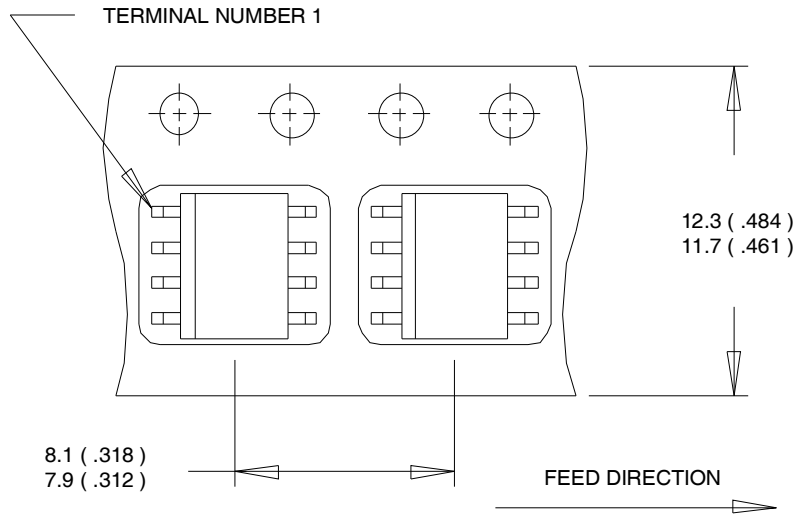


TOP MARKING (LASER)

Note: For the most current drawing please refer to IR website at <http://www.irf.com/package/>

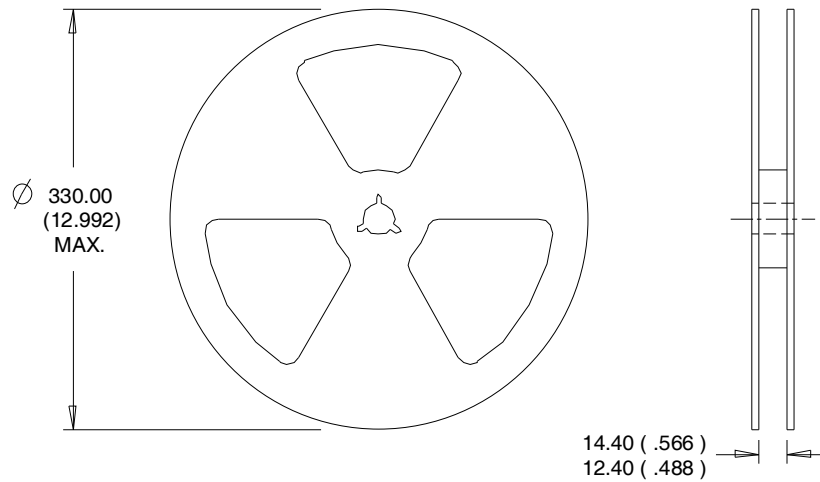
## SO-8 Tape and Reel

Dimensions are shown in millimeters (inches)



**NOTES:**

1. CONTROLLING DIMENSION : MILLIMETER.
2. ALL DIMENSIONS ARE SHOWN IN MILLIMETERS(INCHES).
3. OUTLINE CONFORMS TO EIA-481 & EIA-541.



**NOTES :**

1. CONTROLLING DIMENSION : MILLIMETER.
2. OUTLINE CONFORMS TO EIA-481 & EIA-541.

**Notes:**

- ① Repetitive rating; pulse width limited by max. junction temperature. ( See fig. 10 )
- ② N-Channel  $I_{SD} \leq 2.4A$ ,  $di/dt \leq 73A/\mu s$ ,  $V_{DD} \leq V_{(BR)DSS}$ ,  $T_J \leq 150^\circ C$   
 P-Channel  $I_{SD} \leq -1.8A$ ,  $di/dt \leq 90A/\mu s$ ,  $V_{DD} \leq V_{(BR)DSS}$ ,  $T_J \leq 150^\circ C$
- ③ Pulse width  $\leq 300\mu s$ ; duty cycle  $\leq 2\%$ .
- ④ Surface mounted on FR-4 board,  $t \leq 10sec$ .

## Ordering Information

Base part	Package Type	Standard Pack		Complete Part Number
		Form	Quantity	
AUIRF7379Q	SO-8	Tube	95	AUIRF7379Q
		Tape and Reel	4000	AUIRF7379QTR

## IMPORTANT NOTICE

Unless specifically designated for the automotive market, International Rectifier Corporation and its subsidiaries (IR) reserve the right to make corrections, modifications, enhancements, improvements, and other changes to its products and services at any time and to discontinue any product or services without notice. Part numbers designated with the "AU" prefix follow automotive industry and / or customer specific requirements with regards to product discontinuance and process change notification. All products are sold subject to IR's terms and conditions of sale supplied at the time of order acknowledgment.

IR warrants performance of its hardware products to the specifications applicable at the time of sale in accordance with IR's standard warranty. Testing and other quality control techniques are used to the extent IR deems necessary to support this warranty. Except where mandated by government requirements, testing of all parameters of each product is not necessarily performed.

IR assumes no liability for applications assistance or customer product design. Customers are responsible for their products and applications using IR components. To minimize the risks with customer products and applications, customers should provide adequate design and operating safeguards.

Reproduction of IR information in IR data books or data sheets is permissible only if reproduction is without alteration and is accompanied by all associated warranties, conditions, limitations, and notices. Reproduction of this information with alterations is an unfair and deceptive business practice. IR is not responsible or liable for such altered documentation. Information of third parties may be subject to additional restrictions.

Resale of IR products or serviced with statements different from or beyond the parameters stated by IR for that product or service voids all express and any implied warranties for the associated IR product or service and is an unfair and deceptive business practice. IR is not responsible or liable for any such statements.

IR products are not designed, intended, or authorized for use as components in systems intended for surgical implant into the body, or in other applications intended to support or sustain life, or in any other application in which the failure of the IR product could create a situation where personal injury or death may occur. Should Buyer purchase or use IR products for any such unintended or unauthorized application, Buyer shall indemnify and hold International Rectifier and its officers, employees, subsidiaries, affiliates, and distributors harmless against all claims, costs, damages, and expenses, and reasonable attorney fees arising out of, directly or indirectly, any claim of personal injury or death associated with such unintended or unauthorized use, even if such claim alleges that IR was negligent regarding the design or manufacture of the product.

Only products certified as military grade by the Defense Logistics Agency (DLA) of the US Department of Defense, are designed and manufactured to meet DLA military specifications required by certain military, aerospace or other applications. Buyers acknowledge and agree that any use of IR products not certified by DLA as military-grade, in applications requiring military grade products, is solely at the Buyer's own risk and that they are solely responsible for compliance with all legal and regulatory requirements in connection with such use.

IR products are neither designed nor intended for use in automotive applications or environments unless the specific IR products are designated by IR as compliant with ISO/TS 16949 requirements and bear a part number including the designation "AU". Buyers acknowledge and agree that, if they use any non-designated products in automotive applications, IR will not be responsible for any failure to meet such requirements.

For technical support, please contact IR's Technical Assistance Center  
<http://www.irf.com/technical-info/>

**WORLD HEADQUARTERS:**  
101 N. Sepulveda Blvd., El Segundo, California 90245  
Tel: (310) 252-7105