

HYUNDAI

HY5117410 Series

4M x 4-bit CMOS DRAM with Write-Per-Bit

DESCRIPTION

The HY5117410 is the new generation and fast dynamic RAM organized 4,194,304 x 4-bit with function of Write-Per-Bit. The HY5117410 utilizes Hyundai's CMOS silicon gate process technology as well as advanced circuit techniques to provide wide operating margins to the users. Multiplexed address inputs permit the HY5117410 to be packaged in standard 24/28 pin plastic SOJ, TSOP-II and Reverse TSOP-II.

The package size provides high system bit densities and is compatible with widely available automated testing and insertion equipments. System oriented feature includes single power supply of $5V \pm 10\%$ tolerance and direct interfacing capability with high performance logic families such as Schottky TTL.

FEATURES

- Low power dissipation
Max. battery back-up 2.75mW (L-part)
Max. CMOS standby 2.2mW (L-Part)
5.5mW

Max. TTL standby 11.0mW

Max. operating

Speed	Power
60	660mW
70	550mW
80	468mW

- Single power supply of $5V \pm 10\%$
- TTL compatible inputs and outputs
- Fast access Time

Speed	t _{RAC}	t _{CAC}	t _{PC}
60	60ns	15ns	40ns
70	70ns	18ns	45ns
80	80ns	20ns	50ns

- Fast page mode operation
- Write-Per-Bit and Multi-bit test capability
- Read-Modify-Write capability
- CAS-before-RAS, RAS-only, Hidden refresh
- 2048 refresh cycles / 256ms (L-part)
2048 refresh cycles / 32ms

PIN DESCRIPTION

RAS	Row Address Strobe
CAS	Column Address Strobe
WB/WE	Write-Per-Bit / Write Enable
OE	Output Enable
A0-A10	Address Input
W/DQ0-W/DQ3	Write mask / Data IO
VCC	Power (+ 5V)
VSS	Ground

PIN CONNECTION

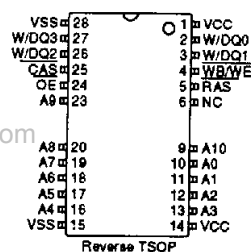
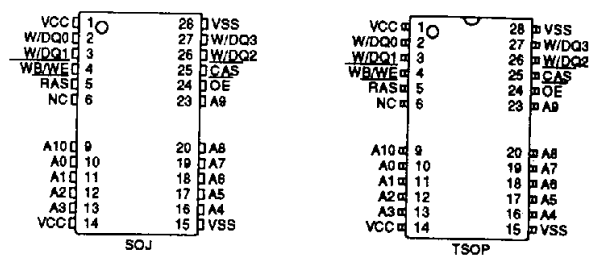

BLOCK DIAGRAM

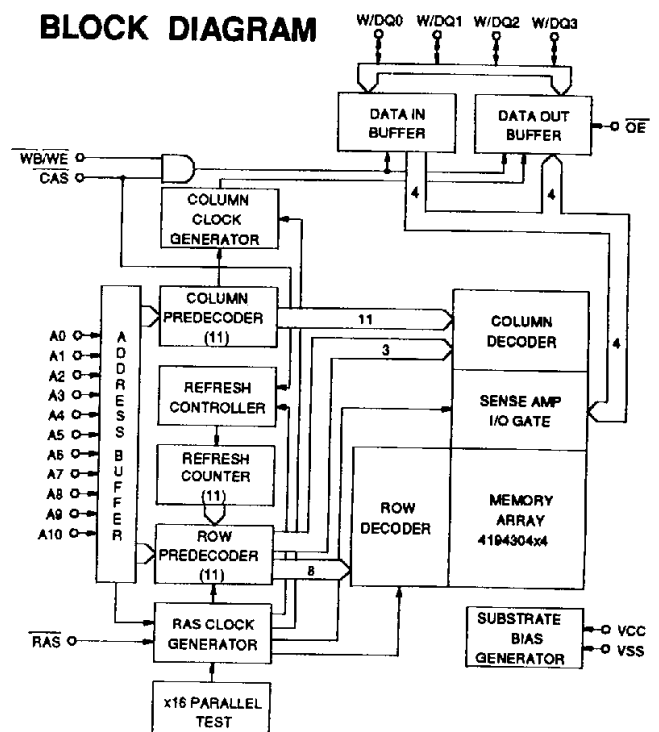

This document is a general product description and is subject to change without notice. Hyundai electronics does not assume any responsibility for use of circuits described. No patent licences are implied.

TAD06-10-MAY94

www.DataSheet4U.com

010

ABSOLUTE MAXIMUM RATINGS

SYMBOL	PARAMETER	RATING	UNIT
TA	Ambient Temperature	0 to 70	°C
TSTG	Storage Temperature	-55 to 150	°C
VIN, VOUT	Voltage on Any Pin Relative to Vss	-1.0 to 7.0	V
VCC	Voltage on Vcc Relative to Vss	-1.0 to 7.0	V
Ios	Short Circuit Output Current	50	mA
PD	Power Dissipation	0.70	W
TSOLDER	Soldering Temperature• Time	260• 10	°C• sec

NOTE : Operation at or above Absolute Maximum Ratings can adversely affect device reliability.

RECOMMENDED DC OPERATING CONDITIONS

(TA= 0°C to 70°C)

SYMBOL	PARAMETER	MIN.	TYP.	MAX.	UNIT
VCC	Power Supply Voltage	4.5	5.0	5.5	V
VIH	Input High Voltage	2.4	-	VCC+ 1.0	V
VIL	Input Low Voltage	-1.0	-	0.8	V

NOTE : All voltages are referenced to Vss.

DC CHARACTERISTICS

(TA= 0°C to 70°C, VCC= 5V± 10%, VSS= 0V, unless otherwise noted.)

SYMBOL	PARAMETER	TEST CONDITIONS	SPEED	MIN.	MAX.	UNIT	NOTE
I _{LI}	Input Leakage Current (Any Input Pins)	V _{SS} ≤ V _{IN} ≤ V _{CC} + 1.0V All other pins not under test= V _{SS}		-10	10	μA	
I _{LO}	Output Leakage Current (High Impedance State)	V _{SS} ≤ V _{OUT} ≤ V _{CC} R _{AS} & C _{AS} at V _{IH}		-10	10	μA	
I _{CC1}	V _{CC} Supply Current, Operating	t _{RC} = t _{RC} (min.)	60 70 80	-	120 100 85	mA	1,2,3
I _{CC2}	V _{CC} Supply Current, TTL Standby	R _{AS} & C _{AS} at V _{IH} , other inputs ≥ V _{SS}		-	2	mA	
I _{CC3}	V _{CC} Supply Current, R _{AS} -only refresh	t _{RC} = t _{RC} (min.)	60 70 80	-	120 100 85	mA	1,3
I _{CC4}	V _{CC} Supply Current, Fast Page mode	t _{PC} = t _{PC} (min.)	60 70 80	-	70 60 50	mA	1,2,3
I _{CC5}	V _{CC} Supply Current, CMOS Standby	R _{AS} & C _{AS} ≥ V _{CC} - 0.2V	L-part	-	1 0.4	mA	5
I _{CC6}	V _{CC} Supply Current, C _{AS} -before-R _{AS} refresh	t _{RC} = t _{RC} (min.)	60 70 80	-	120 100 85	mA	1,3
I _{CC7}	V _{CC} Supply Current, Battery Back Up (L-part only)	t _{RC} = 125μs, C _{AS} = CBR cycling or 0.2V, OE & WB/WE= V _{CC} - 0.2V, A0-A10= V _{CC} - 0.2V or 0.2V, W/DQ0-W/DQ3= 0.2V, V _{CC} - 0.2V, or open	t _{RAS} ≤ 300ns t _{RAS} ≤ 1μs	-	300 500	μA	1,4,5
V _{OL}	Output Low Voltage	I _{OL} = 4.2mA		-	0.4	V	
V _{OH}	Output High Voltage	I _{OH} = -5mA		2.4	-	V	

NOTE :

- I_{CC1}, I_{CC3}, I_{CC4}, I_{CC6} and I_{CC7} depend on cycle rate.
- I_{CC1} and I_{CC4} depend on output loading. Specified values are obtained with the output open.
- It depends on user whether column address is changed or not at least once while R_{AS}= V_{IL} and C_{AS}= V_{IH}.
- t_{RAS}(max.)= 1μs is only applied to refresh of battery backup but t_{RAS}(max.)= 10μs is applied to normal functional operating.
- I_{CC5}(max.)= 0.4mA and I_{CC7} are applied to L-part only (HY5117410LJC, HY5117410LTC, HY5117410LRC).

AC CHARACTERISTICS

(TA= 0°C to 70°C, Vcc= 5V± 10%, Vss= 0V, unless otherwise noted.) NOTE : 1, 2, 3

#	SYMBOL	PARAMETER	HY5117410JC/TC/RC/LJC/LTC/LRC						UNIT	NOTE
			-60		-70		-80			
			MIN.	MAX.	MIN.	MAX.	MIN.	MAX.		
1	tRC	Random Read or Write Cycle Time	110	-	130	-	150	-	ns	
2	tRWC	Read-Modify-Write Cycle Time	155	-	180	-	200	-	ns	
3	tPC	Fast Page Mode Cycle Time	40	-	45	-	50	-	ns	
4	tPRWC	Fast Page Mode Read-Modify-Write Cycle Time	85	-	95	-	100	-	ns	
5	tRAC	Access Time from RAS	-	60	-	70	-	80	ns	4,9,10
6	tCAC	Access Time from CAS	-	15	-	18	-	20	ns	4,9
7	tAA	Access Time from Column Address	-	30	-	35	-	40	ns	4,10
8	tCPA	Access Time from CAS Precharge	-	35	-	40	-	45	ns	4
9	tCLZ	CAS to Output Low Impedance	0	-	0	-	0	-	ns	4
10	tOFF	Output Buffer Turn-off Delay	0	15	0	18	0	20	ns	5
11	tT	Transition Time (Rise and Fall)	3	50	3	50	3	50	ns	3
12	tRP	RAS Precharge Time	40	-	50	-	60	-	ns	
13	tRAS	RAS Pulse Width	60	10K	70	10K	80	10K	ns	
14	tRASP	RAS Pulse Width (Fast Page Mode)	60	400K	70	400K	80	400K	ns	
15	tRSH	RAS Hold Time	15	-	18	-	20	-	ns	
16	tCSH	CAS Hold Time	60	-	70	-	80	-	ns	
17	tCAS	CAS Pulse Width	15	10K	18	10K	20	10K	ns	
18	tRCD	RAS to CAS Delay	20	45	20	52	20	60	ns	9
19	tRAD	RAS to Column Address Delay Time	15	30	15	35	15	40	ns	10
20	tCRP	CAS to RAS Precharge Time	5	-	5	-	5	-	ns	
21	tCP	CAS Precharge Time	10	-	10	-	10	-	ns	
22	tASR	Row Address Set-up Time	0	-	0	-	0	-	ns	
23	tRAH	Row Address Hold Time	10	-	10	-	10	-	ns	
24	tASC	Column Address Set-up Time	0	-	0	-	0	-	ns	
25	tCAH	Column Address Hold Time	10	-	15	-	15	-	ns	
26	tAR	Column Address Hold Time from RAS	50	-	55	-	60	-	ns	
27	tRAL	Column Address to RAS Lead Time	30	-	35	-	40	-	ns	
28	tRCS	Read Command Set-up Time	0	-	0	-	0	-	ns	
29	tRCH	Read Command Hold Time Referenced to CAS	0	-	0	-	0	-	ns	6
30	tRRH	Read Command Hold Time Referenced to RAS	0	-	0	-	0	-	ns	6
31	tWCH	Write Command Hold Time	10	-	15	-	15	-	ns	
32	tWCR	Write Command Hold Time from RAS	45	-	55	-	60	-	ns	
33	tWP	Write Command Pulse Width	10	-	15	-	15	-	ns	
34	tRWL	Write Command to RAS Lead Time	15	-	18	-	20	-	ns	
35	tCWL	Write Command to CAS Lead Time	15	-	18	-	20	-	ns	
36	tDS	Data-In Set-up Time	0	-	0	-	0	-	ns	7
37	tDH	Data-In Hold Time	10	-	15	-	15	-	ns	7
38	tDHR	Data-In Hold Time Referenced to RAS	50	-	55	-	60	-	ns	
39	tREF	Refresh Period (2048 cycle)	-	32	-	32	-	32	ms	
		L-part	-	256	-	256	-	256		11
40	tWCS	Write Command Set-up Time	0	-	0	-	0	-	ns	8

AC CHARACTERISTICS

(continued)

#	SYMBOL	PARAMETER	HY5117410JC/TC/RC/LJC/LTC/LRC						UNIT	NOTE
			-60		-70		-80			
			MIN.	MAX.	MIN.	MAX.	MIN.	MAX.		
41	tCWD	CAS to WE Delay Time	40	-	45	-	45	-	ns	8
42	tRWD	RAS to WE Delay Time	85	-	95	-	105	-	ns	8
43	tAWD	Column Address to WE Delay Time	55	-	60	-	65	-	ns	8
44	tCSR	CAS Set-up Time (CBR Cycle)	10	-	10	-	10	-	ns	
45	tCHR	CAS Hold Time (CBR Cycle)	10	-	15	-	15	-	ns	
46	tRPC	RAS to CAS Precharge Time	5	-	5	-	5	-	ns	
47	tCPT	CAS Precharge Time (CBR Counter Test)	20	-	25	-	25	-	ns	
48	tROH	RAS Hold Time Reference to OE	10	-	15	-	15	-	ns	
49	tOEA	OE Access Time	0	15	0	18	0	20	ns	
50	tOED	OE to Data Delay	15	-	15	-	15	-	ns	
51	tOEZ	Output Buffer Turn Off Delay Time from OE	0	15	0	15	0	15	ns	
52	tOEH	OE Command Hold Time	15	-	15	-	15	-	ns	
53	tCPWD	WE Delay Time from CAS Precharge	60	-	65	-	70	-	ns	8
54	tRHCP	RAS Hold Time from CAS Precharge	35	-	40	-	45	-	ns	
55	tWRP	WE to RAS Precharge Time (CBR Cycle)	10	-	10	-	10	-	ns	
56	tWRH	WE to RAS Hold Time (CBR Cycle)	10	-	10	-	10	-	ns	
57	tWTS	Write Command Set-up Time (Test Mode In)	10	-	10	-	10	-	ns	
58	tWTH	Write Command Hold Time (Test Mode In)	10	-	10	-	10	-	ns	
59	twBS	Write-Per-Bit Set-up Time	0	-	0	-	0	-	ns	
60	twBH	Write-Per-Bit Hold Time	10	-	10	-	10	-	ns	
61	twDS	Write-Per-Bit Selection Set-up Time	0	-	0	-	0	-	ns	
62	twDH	Write-Per-Bit Selection Hold Time	10	-	10	-	10	-	ns	

NOTE :

1. An initial pause of 200 μ s is required after power-up followed by 8 $\overline{\text{RAS}}$ cycles before proper device operation is achieved. In case of using internal refresh counter, a minimum of 8 $\overline{\text{CAS}}$ -before- $\overline{\text{RAS}}$ initialization cycles instead of 8 $\overline{\text{RAS}}$ -only refresh cycles are required. The device should be carefully initialized to be prevented from being entered into multi bit test mode during initialization.
2. AC measurements assume $t_T = 5\text{ns}$.
3. $V_{IH}(\text{min.})$ and $V_{IL}(\text{max.})$ are reference levels for measuring timing of input signals. Also, transition times are measured between V_{IH} and V_{IL} .
4. Measured with a load equivalent to 2 TTL loads and 100pF.
5. $t_{OFF}(\text{max.})$ and t_{OEZ} define the time at which the output achieves the open circuit condition and is not referenced to output voltage levels.
6. Either t_{RCH} or t_{RRH} must be satisfied for a read cycle.
7. These parameters are referenced to $\overline{\text{CAS}}$ leading edge in early write cycles and to $\overline{\text{WE}}$ leading edge in Read-Modify-Write cycles.
8. $t_{WCS}, t_{RWD}, t_{CWD}$, t_{AWD} and t_{CPWD} are not restrictive operating parameters. They are included in the data sheet as electrical characteristics only. If $t_{WCS} \geq t_{WCS}(\text{min.})$, the cycle is an early write cycle and data out pin will remain open circuit (high impedance) through the entire cycle. If $t_{RWD} \geq t_{RWD}(\text{min.})$, $t_{CWD} \geq t_{CWD}(\text{min.})$, $t_{AWD} \geq t_{AWD}(\text{min.})$, and $t_{CPWD} \geq t_{CPWD}(\text{min.})$, the cycle is a Read-Modify-Write cycle and data out will contain data read from the selected cell. If neither of the above sets of conditions is satisfied, the condition of the data out (at access time) is indeterminated.
9. Operation within the $t_{RCD}(\text{max.})$ limit insures that $t_{RAC}(\text{max.})$ can be met. $t_{RCD}(\text{max.})$ is specified as a reference point only. If t_{RCD} is greater than the specified $t_{RCD}(\text{max.})$ limit, then access time is controlled by t_{CAC} .
10. Operation within the $t_{RAD}(\text{max.})$ limit insures that $t_{RAC}(\text{max.})$ can be met. $t_{RAD}(\text{max.})$ is specified as a reference point only. If t_{RAD} is greater than the specified $t_{RAD}(\text{max.})$ limit, then access time is controlled by t_{AA} .
11. $t_{REF}(\text{max.}) = 256\text{ms}$ is applied to L-part only (HY5117410LJC, HY5117410LTC, HY5117410LRC).

CAPACITANCE

($T_A = 25^\circ\text{C}$, $V_{CC} = 5\text{V} \pm 10\%$, $V_{SS} = 0\text{V}$, $f = 1\text{MHz}$, unless otherwise noted.)

SYMBOL	PARAMETER	TYP.	MAX.	UNIT
CIN1	Input Capacitance (A0-A10)	-	5	pF
CIN2	Input Capacitance ($\overline{\text{RAS}}$, $\overline{\text{CAS}}$, $\overline{\text{WB/WE}}$, $\overline{\text{OE}}$)	-	7	pF
CDQ	Data Input/Output Capacitance (DQ0-DQ3)	-	7	pF

TIMING DIAGRAM

READ CYCLE

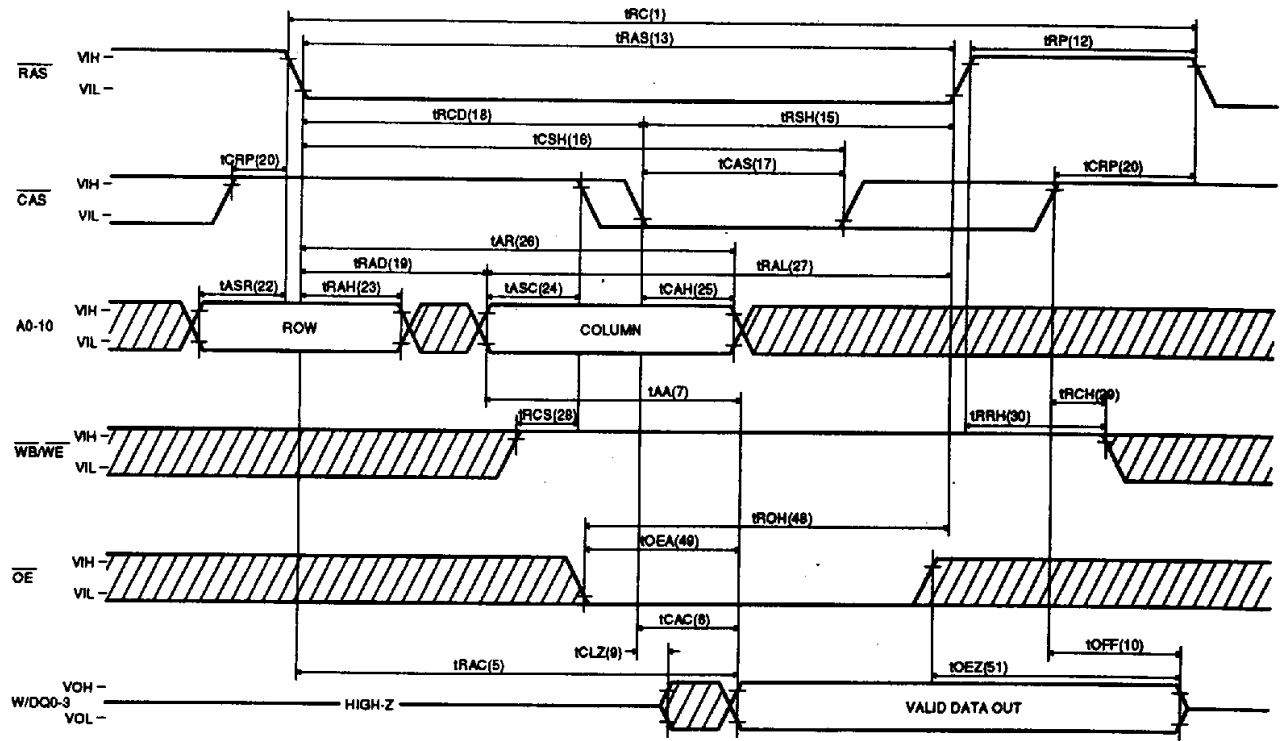

EARLY WRITE CYCLE

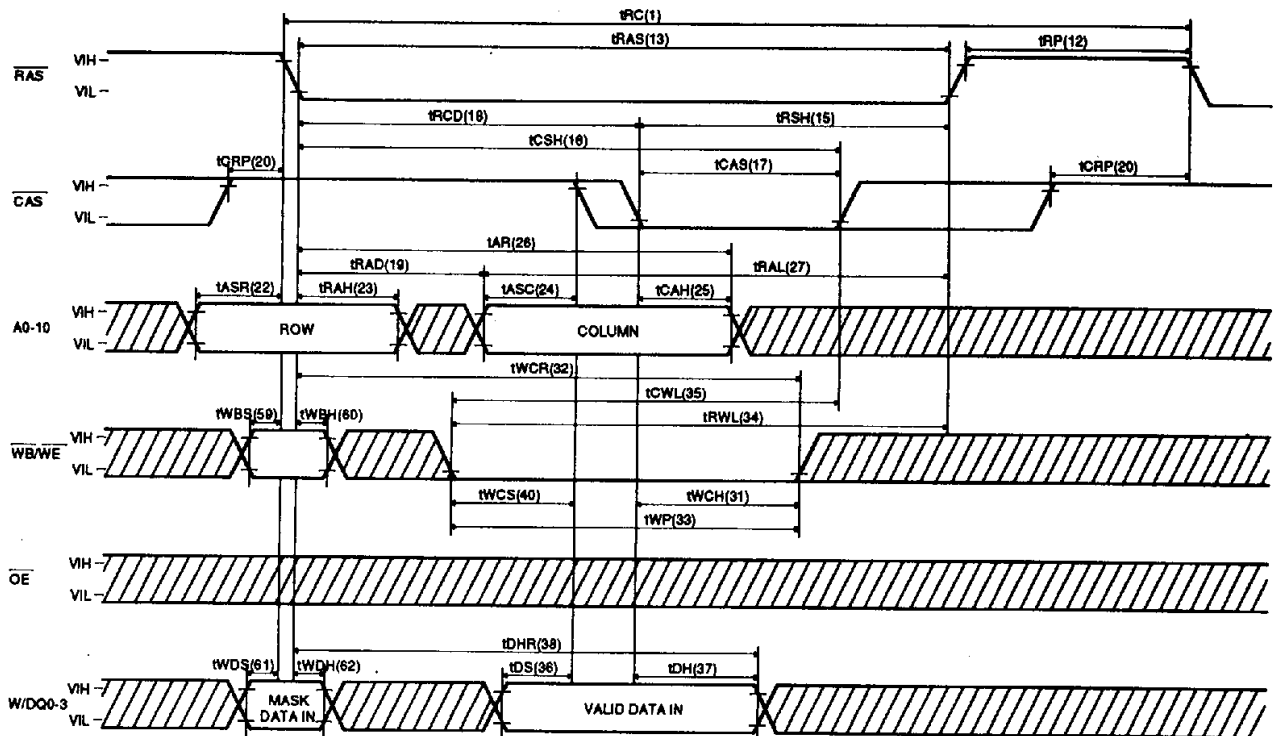

WRITE CYCLE (OE CONTROLLED WRITE)

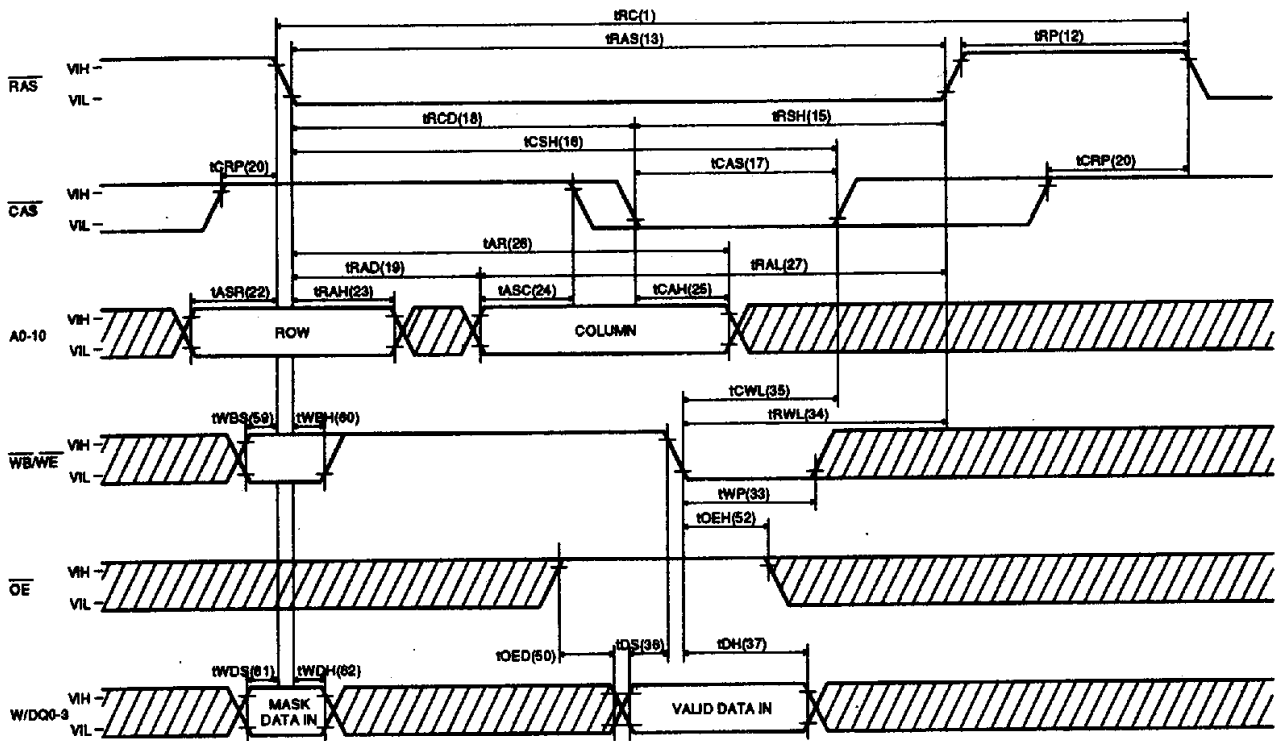

READ-MODIFY-WRITE CYCLE

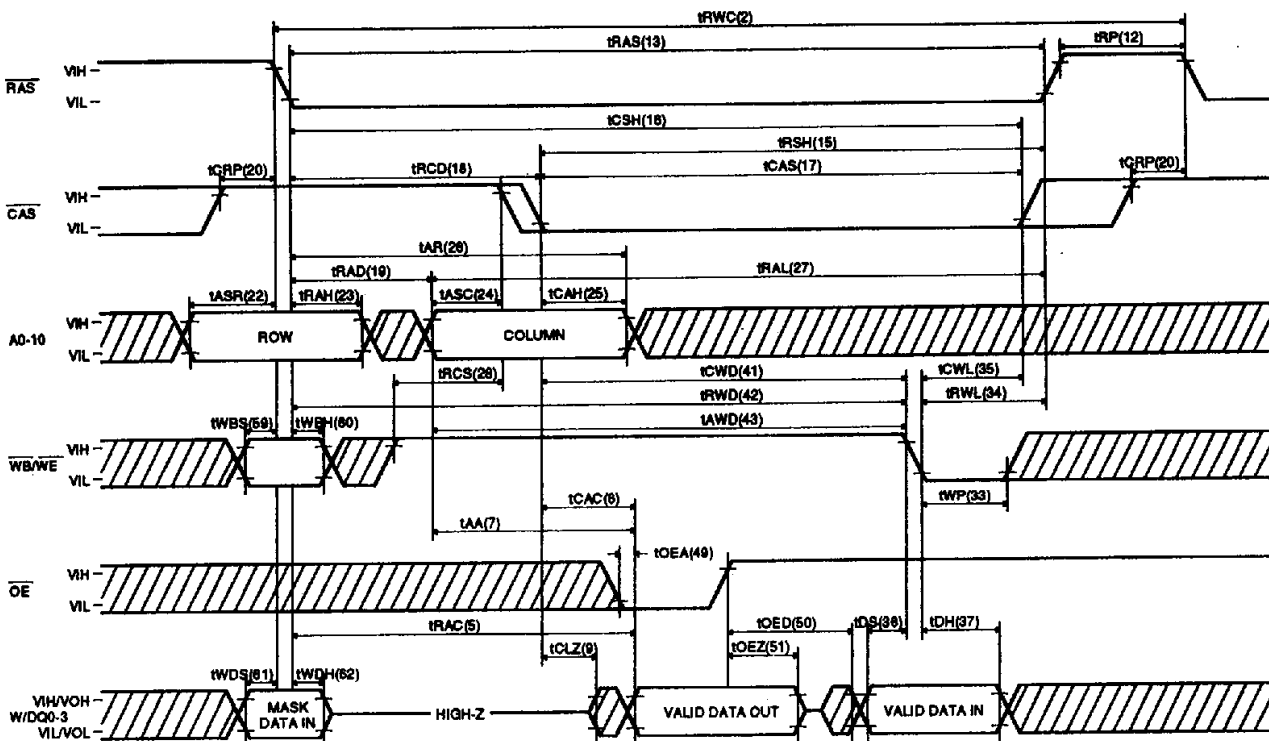

FAST PAGE MODE READ CYCLE

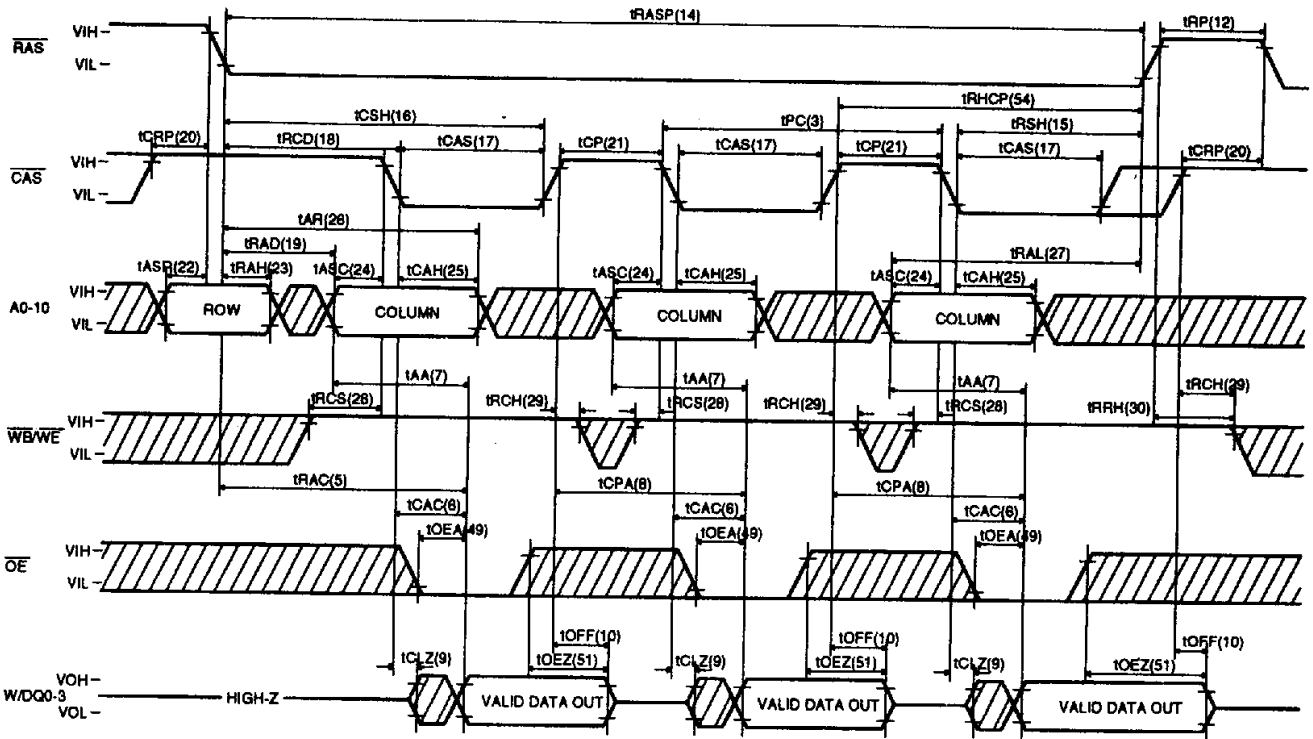

DataSheet4U.com

DataSheet4U.com

FAST PAGE MODE EARLY WRITE CYCLE

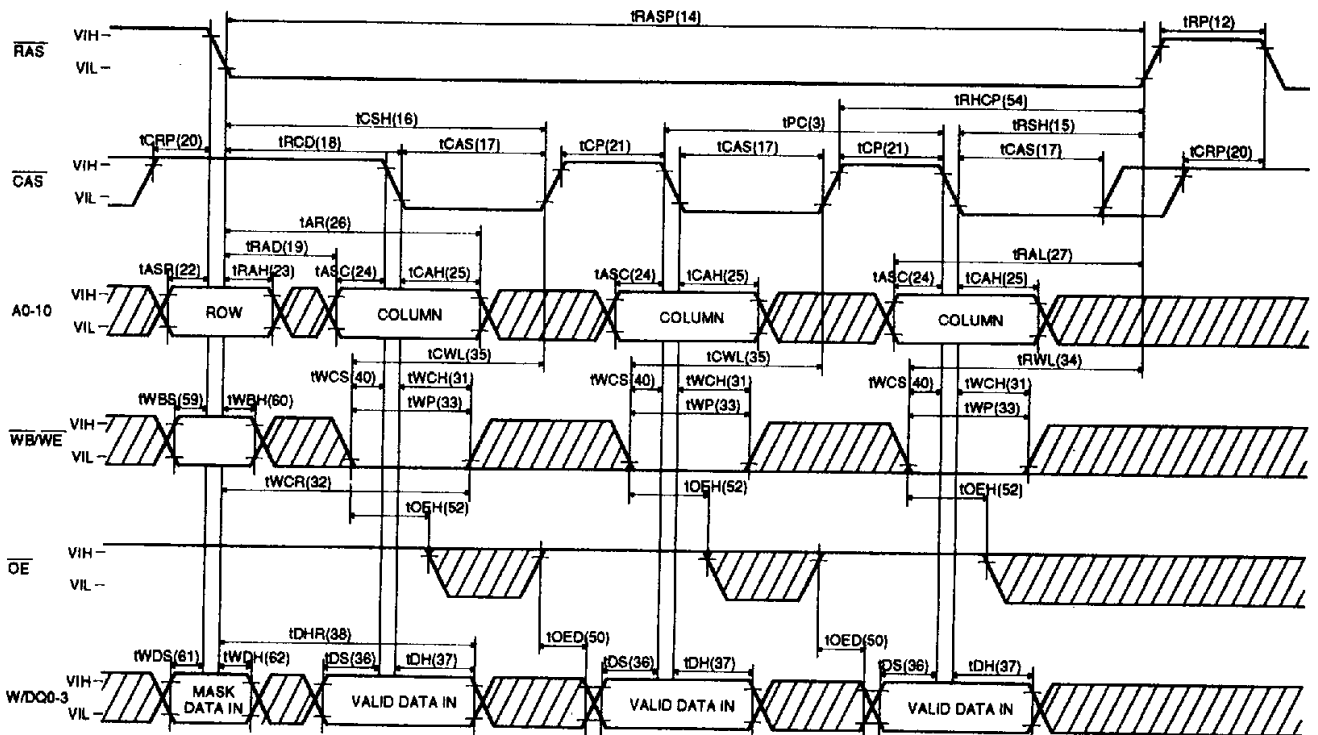

FAST PAGE MODE READ-MODIFY-WRITE CYCLE

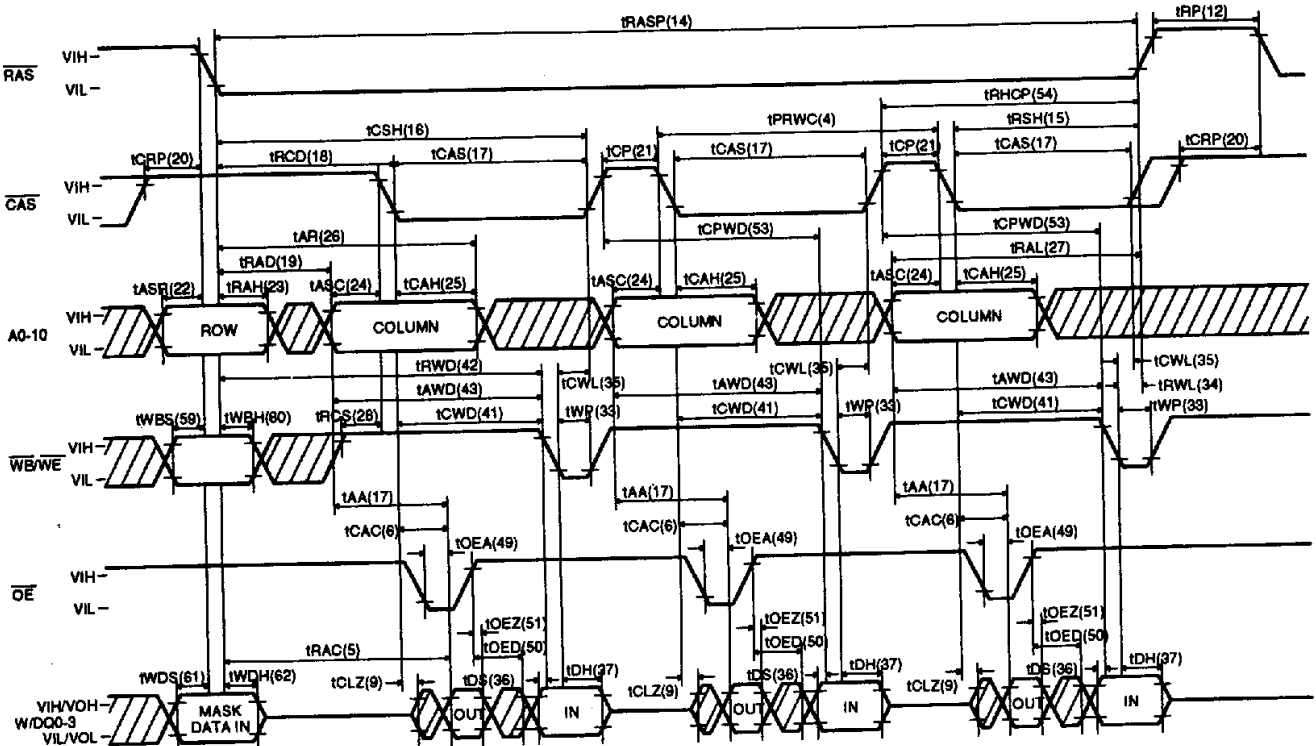

RAS-ONLY REFRESH CYCLE

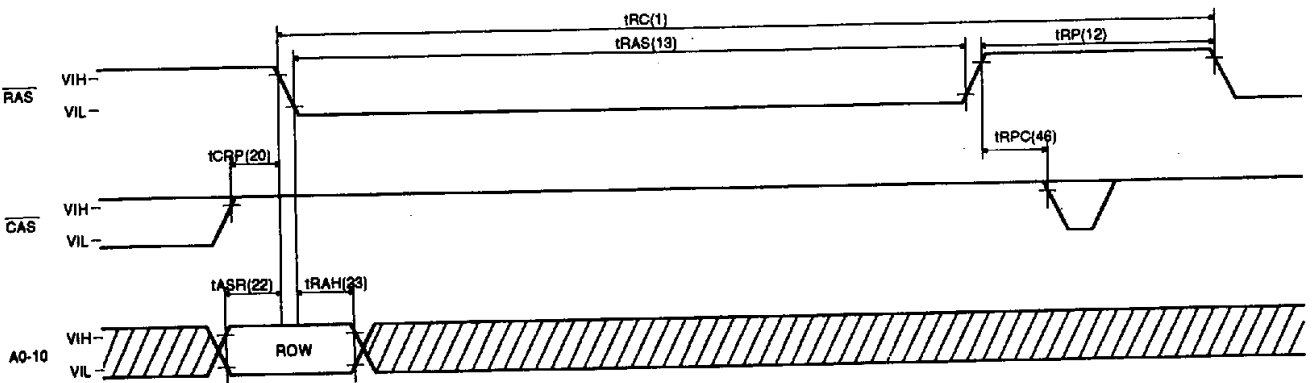

NOTE: OE and WB/WE = "H" or "L"

CAS-BEFORE-RAS REFRESH CYCLE

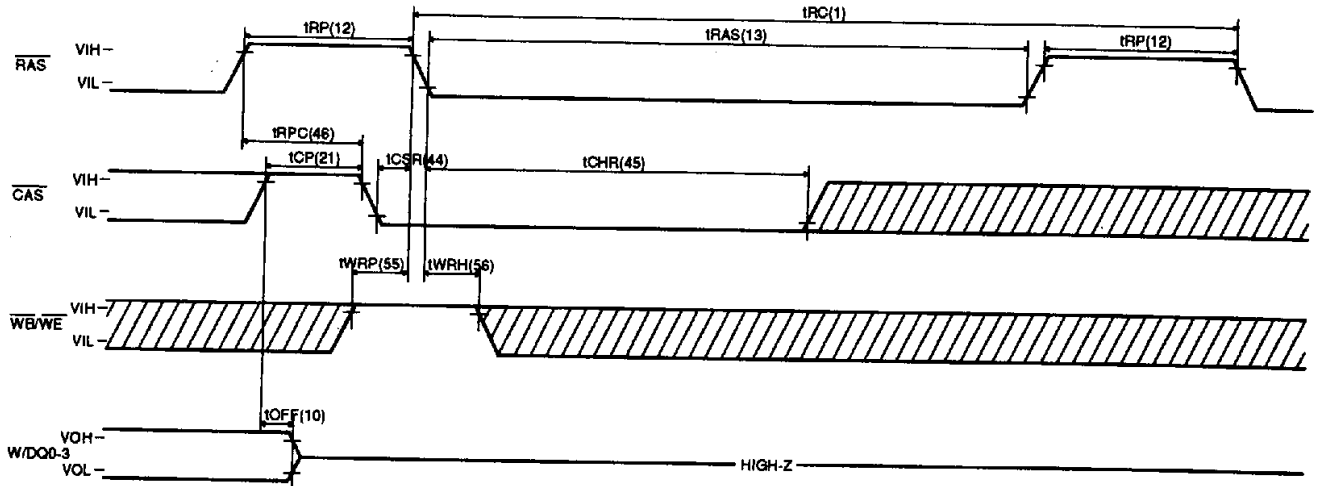

NOTE : A0-11 and OE = "H" or "L"

HIDDEN REFRESH CYCLE (READ)

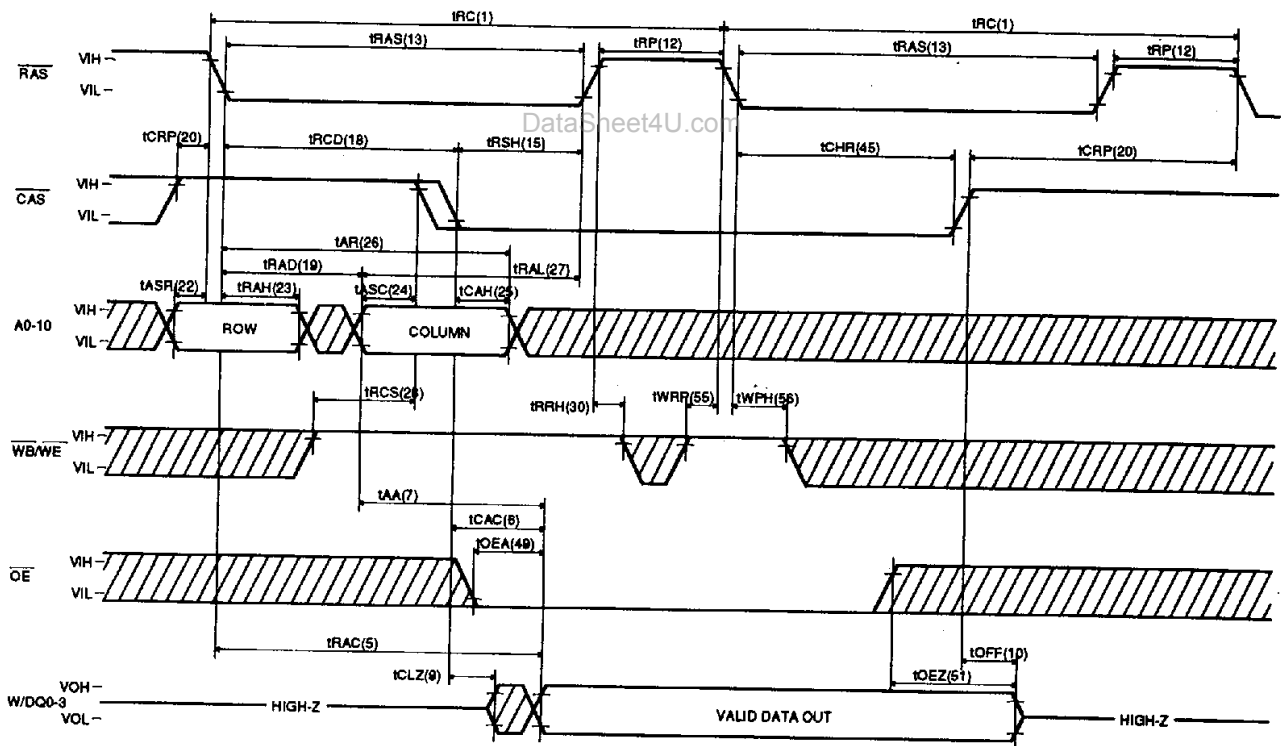

HIDDEN REFRESH CYCLE (WRITE)

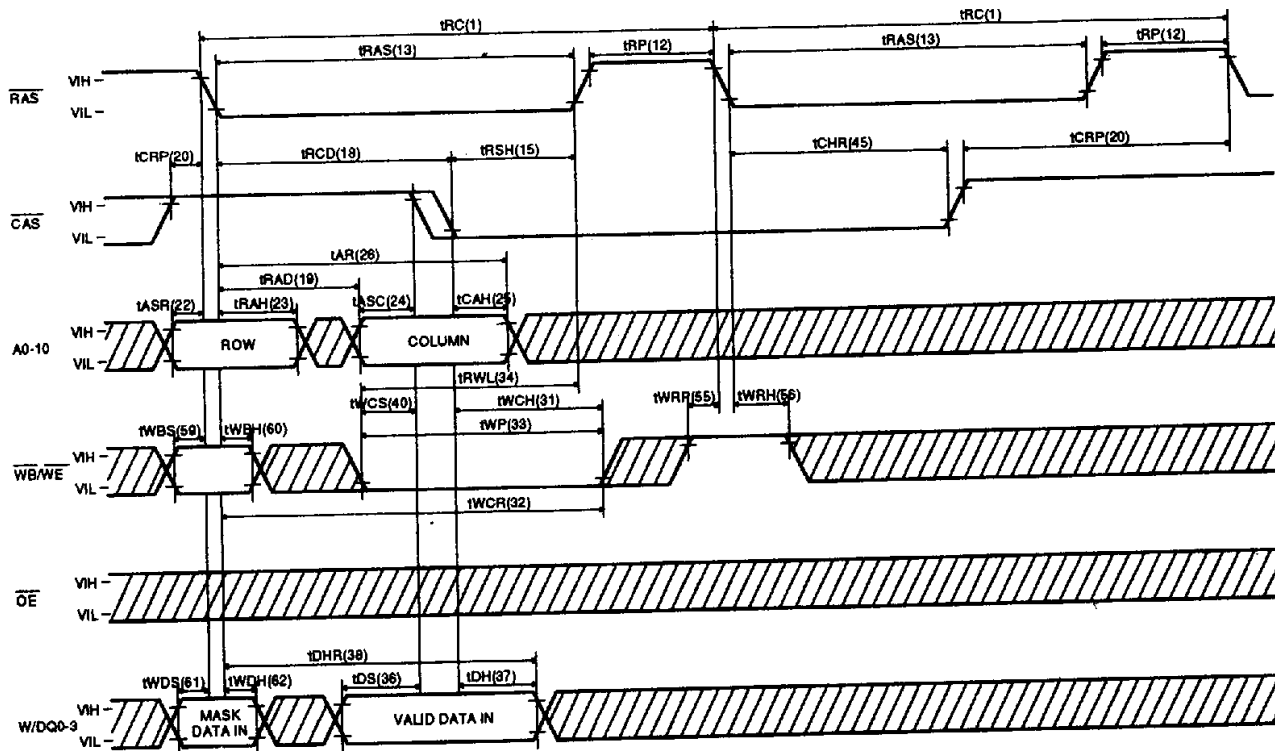

et4U.com

DataSheet4U.com

DataShee

CAS-BEFORE-RAS REFRESH COUNTER TEST CYCLE

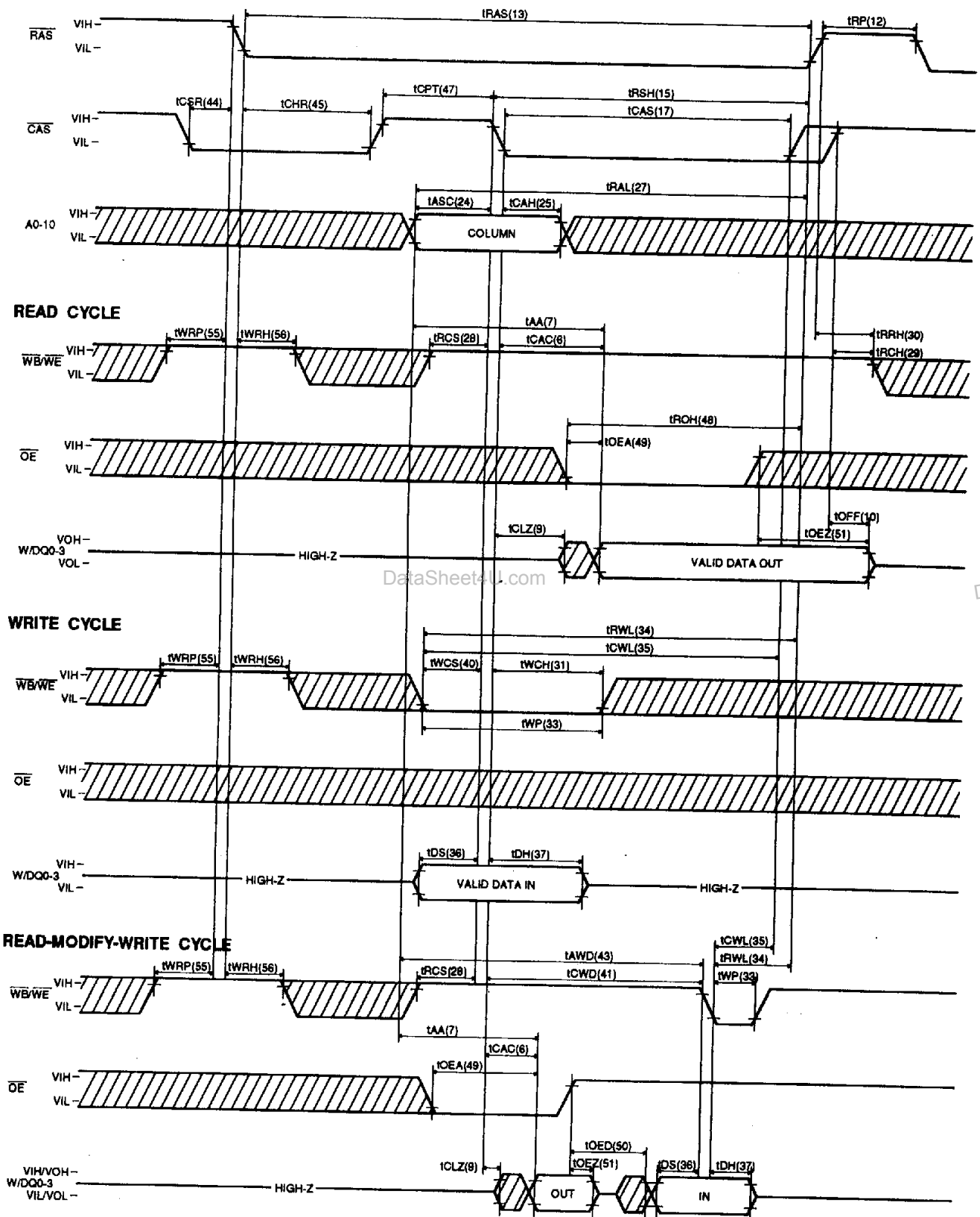

TEST MODE

The HY5117410 is a DRAM organized 4,194,304 x 4-bit. It is internally organized 1,048,576 x 16-bit. In Test Mode, data are written into 16 sectors (Each is composed of 1M bits) in parallel and retrieved the same way. Column address A0 and A1 are not used. If, upon reading, 4-bit data from 4 sectors connected to one DQ pin are equal (all "1"s or "0"s), the DQ pin indicates a "0". Below shows the timing diagram of the HY5117410 to enter Test Mode. In Test Mode, the 4Mx4 DRAM can be tested as if it were a 1Mx4 DRAM. \overline{WE} , \overline{CAS} -before- \overline{RAS} cycle (Test Mode In Cycle) puts the HY5117410 into Test Mode and \overline{CAS} -before- \overline{RAS} or \overline{RAS} -only refresh cycle puts it back into Normal Mode. In Test Mode, \overline{WE} , \overline{CAS} -before- \overline{RAS} cycle shall be used for the refresh operation. The Test Mode function reduces test time (1/4 in case of N test pattern).

TEST MODE IN CYCLE

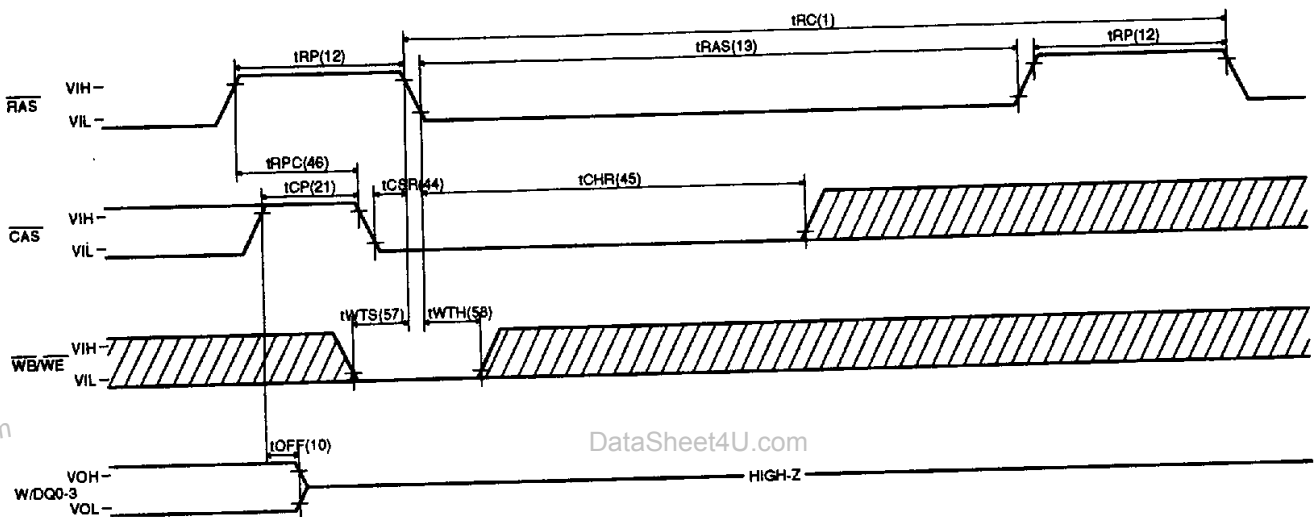

et4U.com

DataSheet4U.com

DataShee

BLOCK DIAGRAM IN TEST MODE

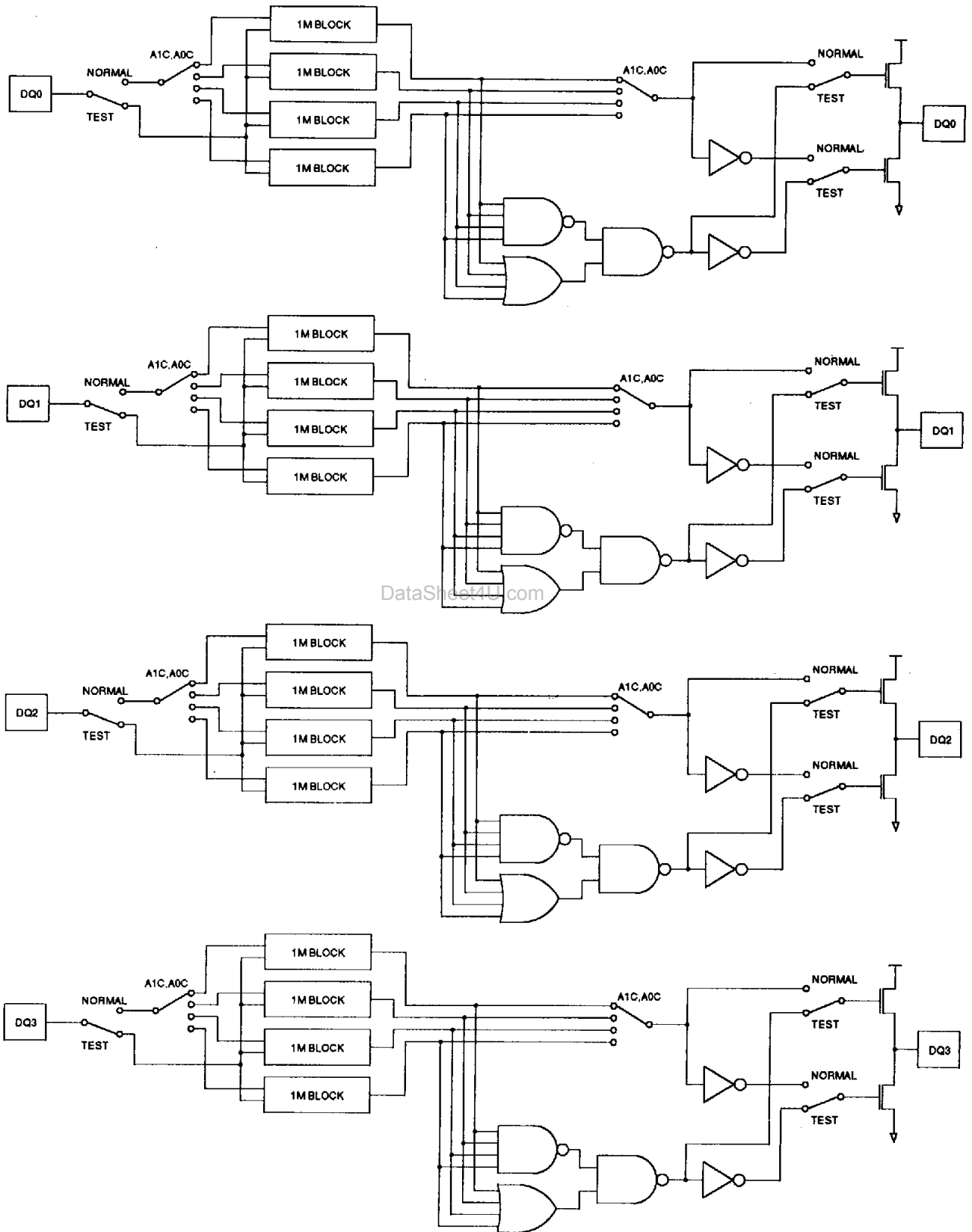

WRITE-PER-BIT FUNCTION

The Write-Per-Bit function selectively controls the internal write enable circuit of the HY5117410. When $\overline{WB/WE}$ is held "Low" at the falling edge of \overline{RAS} during a random access operation, the write mask is enabled. At the same time, the mask data on the W/DQ pins is located onto the write mask register (WMR). When a "0" is sensed on any of the W/DQ pins, their corresponding write circuits are disabled and new data will not be written. When "1" is sensed on any of the W/DQ pins, their corresponding write circuit will remain enabled so that new data is written. The truth table of the Write-Per-Bit function and an example of the Write-Per-Bit function illustrating its application to displays are shown below.

TRUTH TABLE FOR WRITE-PER-BIT FUNCTION

at the falling edge of \overline{RAS}				Function
CAS	OE	WB/WE	W/DQ0-3	
H	H	H	Don't Care	Write Enable
H	H	L	1	Write Enable
			0	Write Mask

WRITE-PER-BIT TIMING DIAGRAM

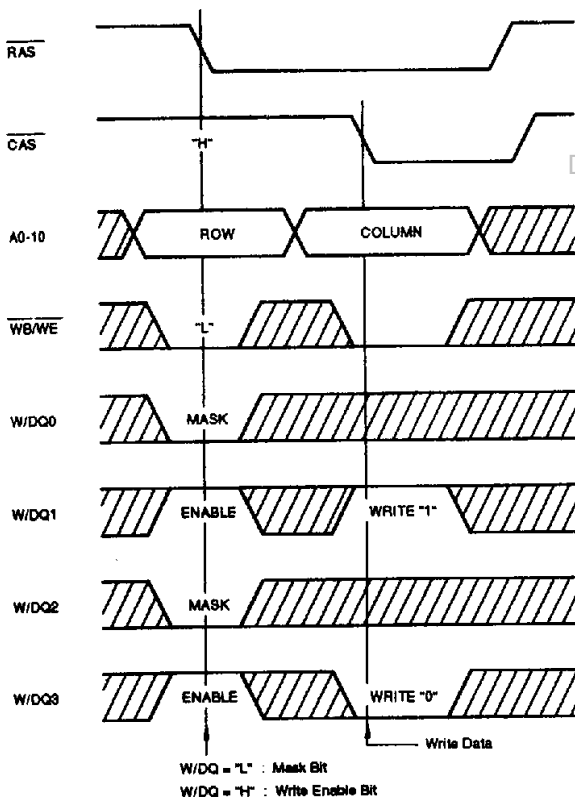

CORRESPONDING BIT MAP

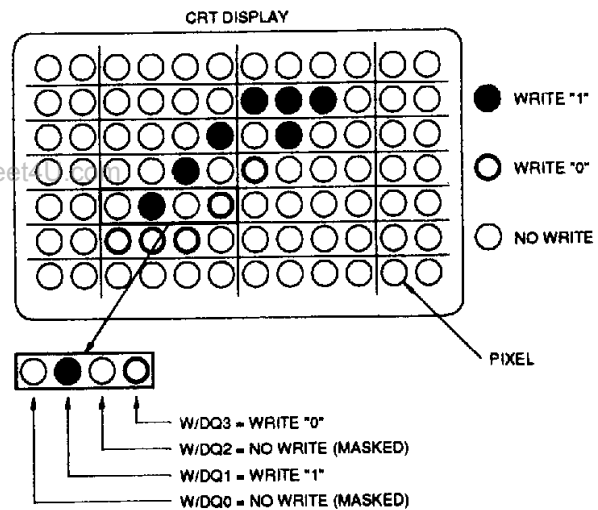

PACKAGE INFORMATION

400 mil 24/28 pin Small Outline J-form Package (JC)

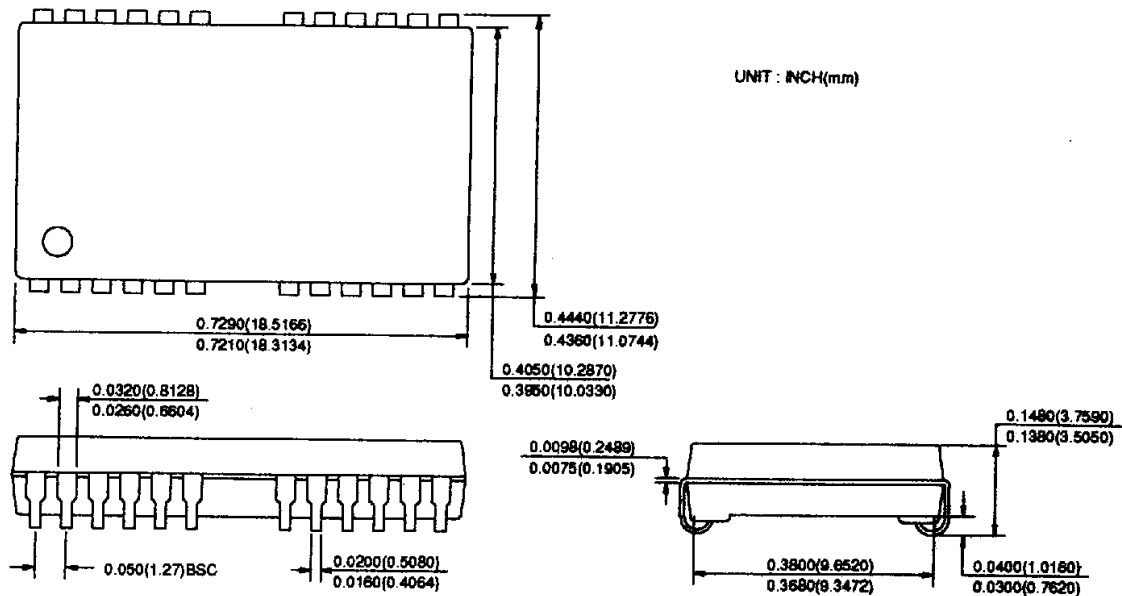

400 mil 24/28 pin Thin Small Outline Package (TC) (RC)

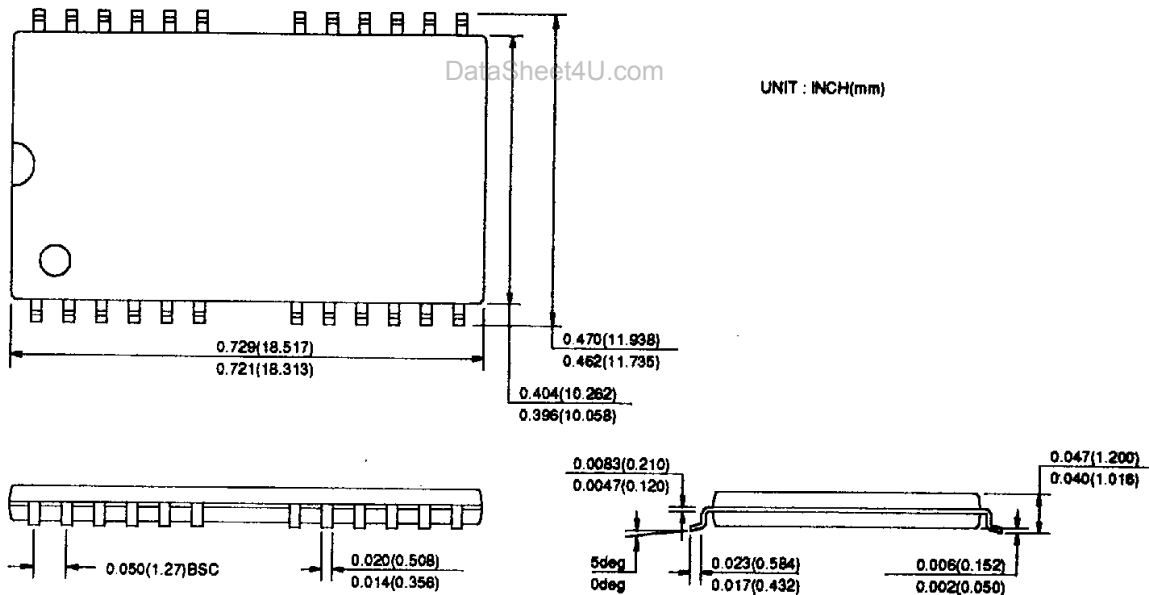

ORDERING INFORMATION

PART NO	SPEED	POWER	PACKAGE
HY5117410JC	60/70/80		SOJ
HY5117410LJC	60/70/80	L-part	SOJ
HY5117410TC	60/70/80		TSOP-II
HY5117410LTC	60/70/80	L-part	TSOP-II
HY5117410RC	60/70/80		TSOP-II(R)
HY5117410LRC	60/70/80	L-part	TSOP-II(R)