

1000BASE-T MAGNETICSMODULES

Designed to Support 1:1 Turns Ratio Transceivers

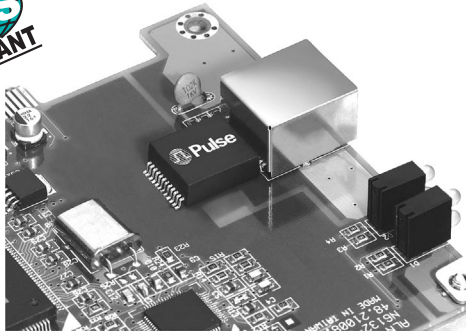

- RoHS peak reflow temperature rating 245°C
- Meets IEEE 802.3 specification

Electrical Specifications @ 25°C — Operating Temperature 0°C to 70°C

RoHS Compliant Part Number	Number of Ports	Insertion Loss (dB MAX)	Return Loss (dB MIN)					Differential to Common Mode Rejection (dB MIN)			Crosstalk (dB MIN)			Hipot (Vrms)
			1-100 MHz	1-30 MHz	40 MHz	50 MHz	60-80 MHz	100 MHz	30 MHz	60 MHz	100 MHz	30 MHz	60 MHz	
H5004NL 3d	1	1	-18	-18	-16	-12	-10	-43	-37	-33	-43	-37	-33	1500
HX5004NL 1,3d	1	1	-18	-18	-16	-12	-10	-43	-37	-33	-43	-37	-33	1500
H5007NL 3d	1	1	-18	-18	-16	-12	-10	-43	-37	-33	-43	-37	-33	1500
H5008NL 3a	1	1	-18	-18	-16	-12	-10	-43	-37	-33	-43	-37	-33	1500
HX5008NL 1,3a	1	1	-18	-18	-16	-12	-10	-43	-37	-33	-43	-37	-33	1500
H5009NL 3a	1	1	-18	-18	-16	-12	-10	-43	-37	-33	-43	-37	-33	1500
H5012NL 3a	2	1.4	-16	-14.4	-13.1	-12	-10	-45	-40	-35	-43.5	-37.5	-33	1500
H5014NL 3a	2	1.4	-16	-14.4	-13.1	-12	-10	-45	-40	-35	-43.5	-37.5	-33	1500
HX5014NL 1,3a	2	1.4	-16	-14.4	-13.1	-12	-10	-45	-40	-35	-43.5	-37.5	-33	1500
H5015NL 3a	1	1	-18	-18	-16	-12	-10	-43	-37	-33	-43	-37	-33	1500
H5020NL 3a	2	1	-18	-14.4	-13.1	-12	-10	-40	-35	-30	-40	-33	-28	1500
HX5020NL 1,3a	2	1	-18	-14.4	-13.1	-12	-10	-40	-35	-30	-40	-33	-28	1500
H5089NL 3a	2	1.4	-16	-14.4	-13.1	-12	-10	-45	-40	-35	-43.5	-37.5	-33	1500

1. HX = extended temperature version -40°C to +85°C
2. For Tape & Reel packaging, add a "T" suffix at the end of the part number, e.g. H5007NLT.
3. MSL = Moisture Sensitivity Level: a = 1, b = 2, c = 3, d = 4

Mechanicals

H5004NL, HX5004NL*, H5007NL*

H5004NL, H5007NL, and HX5004NL are footprint-compatible to 10/100BASE-TX part H1267.

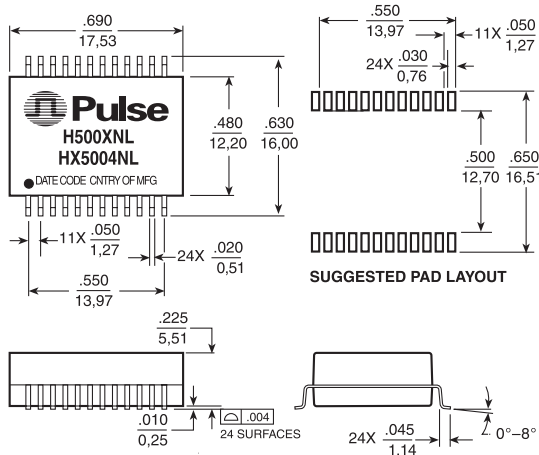

H5008NL, H5009NL, HX5008NL

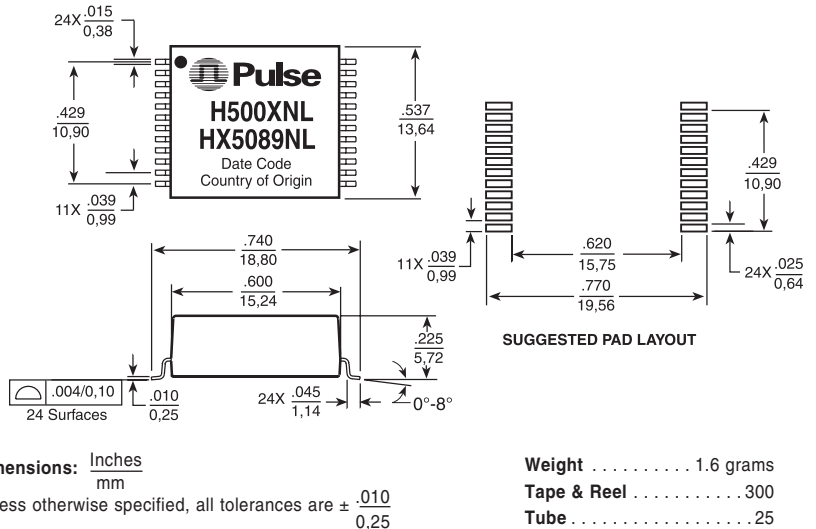

1000BASE-T MAGNETICSMODULES

Designed to Support 1:1 Turns Ratio Transceivers



Mechanicals (continued)

H5012NL, H5014NL, HX5014NL, H5089NL

H5020NL, HX5020NL

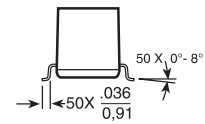
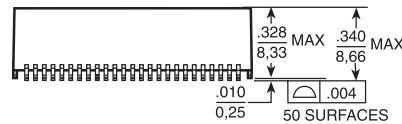
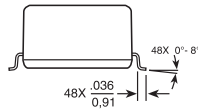
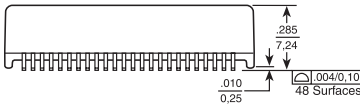
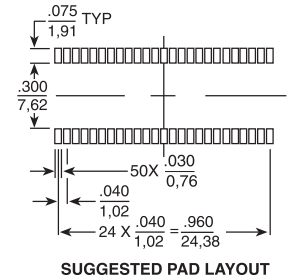
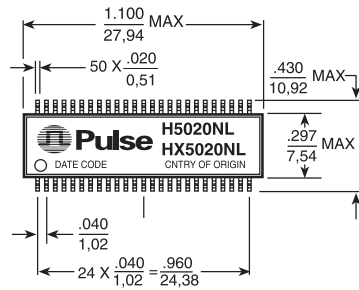
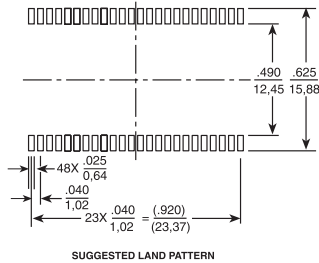
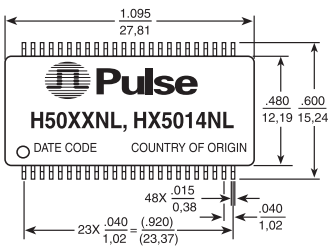

Weight 4.0 grams
Tape & Reel 250/reel
Tube 15/tube

Dimensions: $\frac{\text{Inches}}{\text{mm}}$
Unless otherwise specified, all tolerances are $\pm \frac{.010}{0.25}$

Weight 1.6 grams
Tape & Reel 250/reel
Tube 15/tube

H5015NL

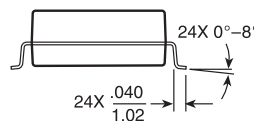
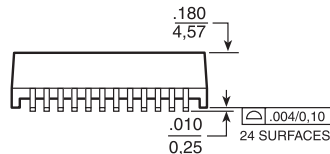
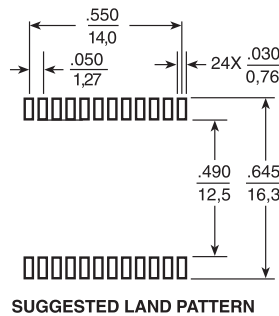
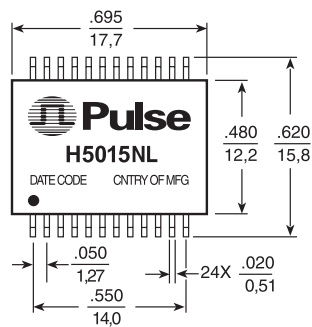

Weight 1.5 grams
Tape & Reel 400/reel

Dimensions: $\frac{\text{Inches}}{\text{mm}}$
Unless otherwise specified, all tolerances are $\pm \frac{.005}{0.13}$

1000BASE-T MAGNETICSMODULES

Designed to Support 1:1 Turns Ratio Transceivers



Schematics

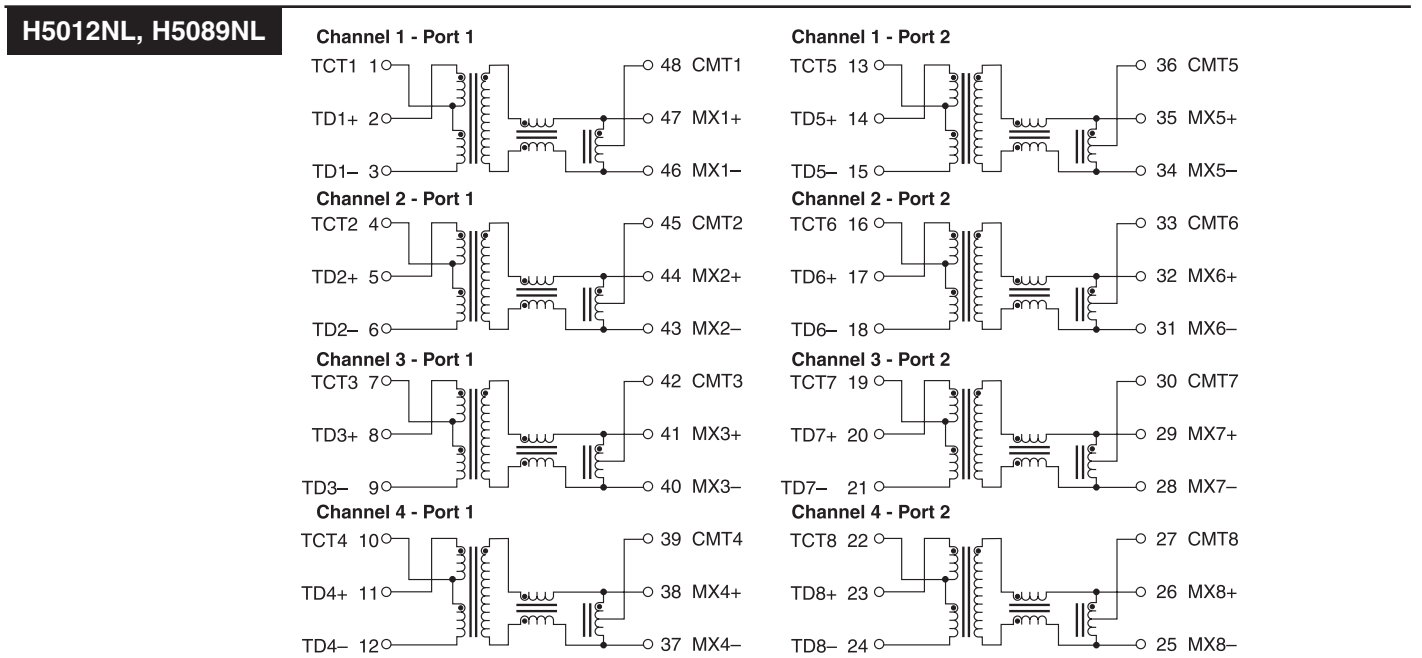
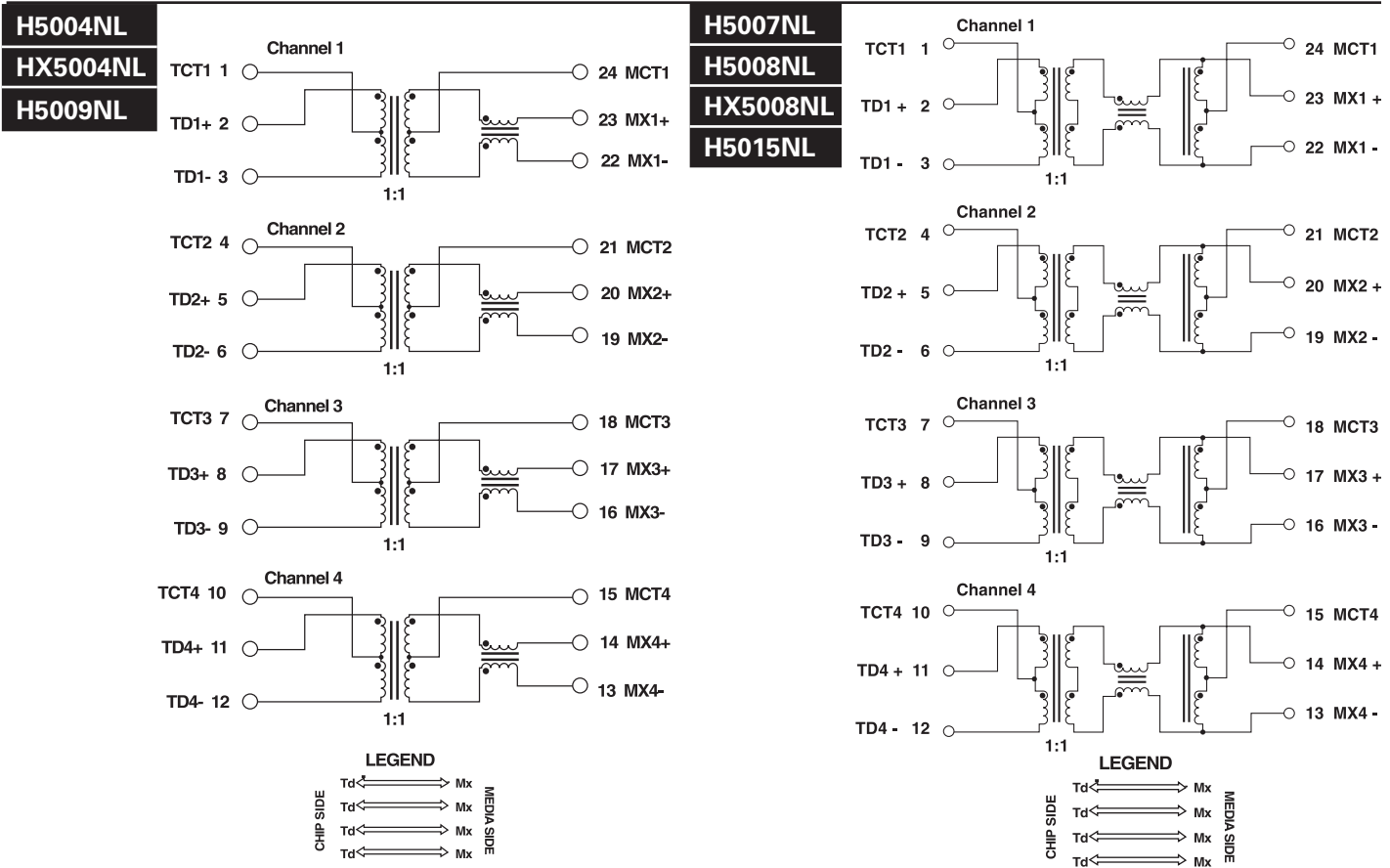

1000BASE-T MAGNETICSMODULES

Designed to Support 1:1
Turns Ratio Transceivers



Schematics (continued)

H5014NL, HX5014NL

Channel 1 - Port 1

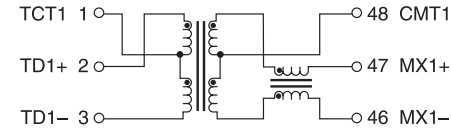

Channel 2 - Port 1

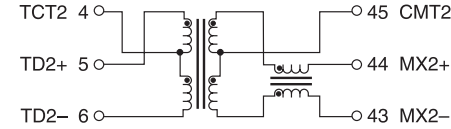

Channel 3 - Port 1

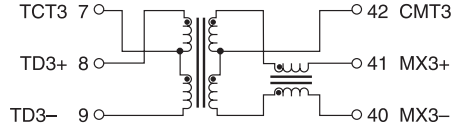

Channel 4 - Port 1

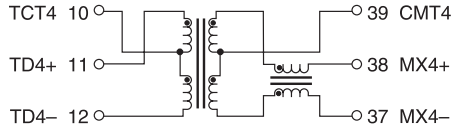

Channel 1 - Port 2

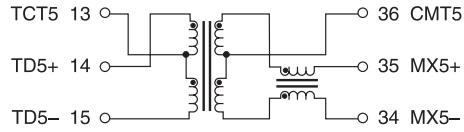

Channel 2 - Port 2

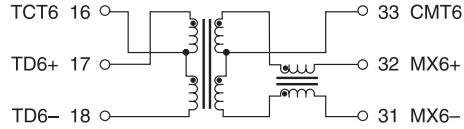

Channel 3 - Port 2

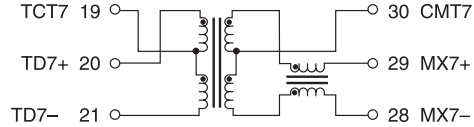

Channel 4 - Port 2

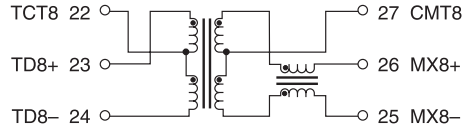

H5020NL, HX5020NL

Channel 1 - Port 1

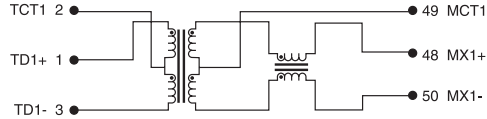

Channel 2 - Port 1

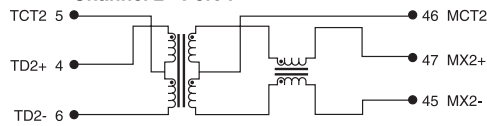

Channel 3 - Port 1

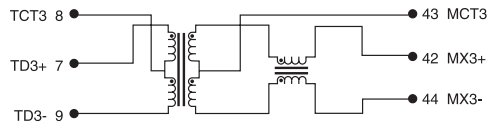

Channel 4 - Port 1

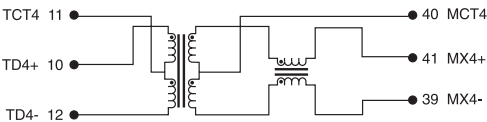

Channel 1 - Port 2

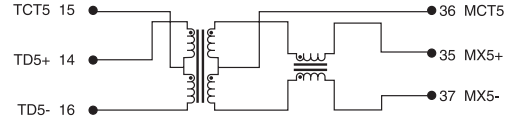

Channel 2 - Port 2

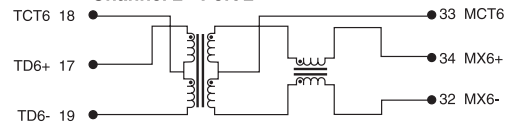

Channel 3 - Port 2

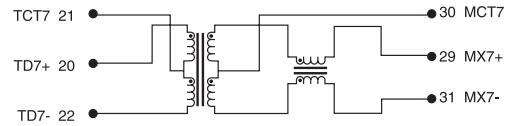

Channel 4 - Port 2

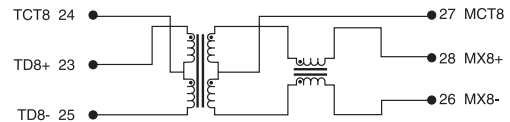

For More Information:

Pulse Worldwide Headquarters
12220 World Trade Dr.
San Diego, CA 92128
U.S.A.

Pulse Europe
Einsteinstrasse 1
D-71083 Herrenberg
Germany

Pulse China Headquarters
B402, Shenzhen Academy of
Aerospace Technology Bldg.
10th Kejinan Rd.
High-Tech Zone
Nanshan District
Shenzhen, PR China 518057

Pulse North China
Room 2704/2705
Super Ocean Finance Ctr.
2067 Yan An Rd. West
Shanghai 200336
China

Pulse South Asia
135 Joo Seng Rd.
#03-02
PM Industrial Bldg.
Singapore 368363

Pulse North Asia
3F, No. 198
Zhongyuan Rd.
Zhongli City
Taoyuan County 320
Taiwan R. O. C.

www.pulseeng.com

Tel: 858 674 8100
Fax: 858 674 8262

Tel: 49 7032 7806 0
Fax: 49 7032 7806 135

Tel: 86 755 33966678
Fax: 86 755 33966700

Tel: 86 21 62787060
Fax: 86 2162786973

Tel: 65 6287 8998
Fax: 65 6287 8998

Tel: 886 3 4356768
Fax: FRE 886 3 4356820
Pulse: 886 3 4356823

Performance warranty of products offered on this data sheet is limited to the parameters specified. Data is subject to change without notice. Other brand and product names mentioned herein may be trademarks or registered trademarks of their respective owners.

© Copyright, 2010. Pulse Engineering, Inc. All rights reserved.