

CDBD540-HF Thru. CDBD5200-HF

Reverse Voltage: 40 to 200 Volts

Forward Current: 5.0 Amp

RoHS Device

Halogen Free

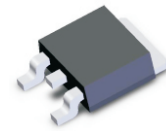

Features

- Batch process design, excellent power dissipation offers better reverse leakage current and thermal resistance.
- Low power loss, high efficiency.
- High current capability, low forward voltage drop.
- High surge capability.
- Guard ring for over voltage protection.
- Ultra high-speed switching.
- Silicon epitaxial planar chip, metal silicon junction.
- Lead-free parts meet environmental standards of MIL-STD-19500 /228

Mechanical data

- Epoxy: UL94-V0 rated flame retardant.
- Case: Molded plastic, TO-252/DPAK
- Terminals: Solder plated, solderable per MIL-STD-750, Method 2026.
- Mounting Position: Any
- Weight: 0.34 grams (approx.).

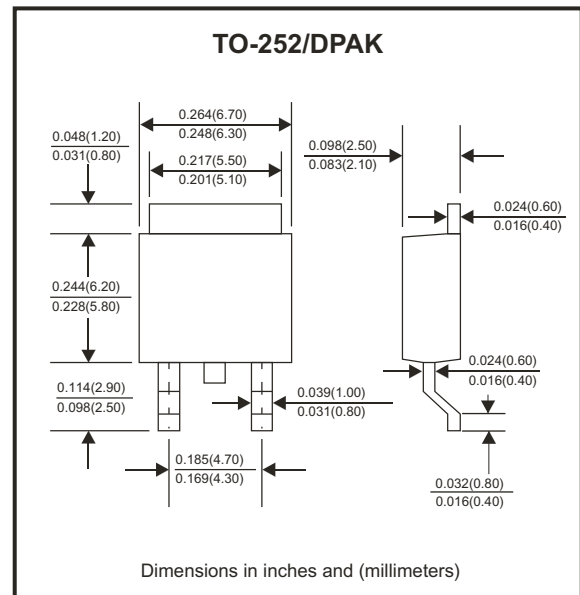

Circuit diagram

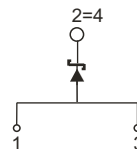

Maximum Ratings and Electrical Characteristics (at TA=25°C unless otherwise noted)

Parameter	Symbol	CDBD 540-HF	CDBD 545-HF	CDBD 560-HF	CDBD 5100-HF	CDBD 5150-HF	CDBD 5200-HF	Unit
Repetitive peak reverse voltage	V_{RRM}	40	45	60	100	150	200	V
Continuous reverse voltage	V_R	40	45	60	100	150	200	V
RMS voltage	V_{RMS}	28	31.5	42	70	105	140	V
Maximum forward voltage $I_F=5.0A$	V_F	0.55		0.70	0.85	0.90	0.92	V
Forward rectified current (See fig. 1)	I_o	5.0						A
Forward surge current, 8.3ms single half sine-wave superimposed on rated load (JEDEC method)	I_{FSM}	150						A
Reverse current	$V_R=V_{RRM}$ $T_A=25^\circ C$	0.5						mA
	$V_R=V_{RRM}$ $T_A=100^\circ C$	20						mA
Operating temperature	T_J	-55 to +125			-55 to +150			°C
Storage temperature	T_{STG}	-65 to +175						°C

Company reserves the right to improve product design , functions and reliability without notice.

REV:B

RATING AND CHARACTERISTIC CURVES (CDBD540-HF Thru. CDBD5200-HF)

Fig.1 - Typical Forward Current Derating Curve

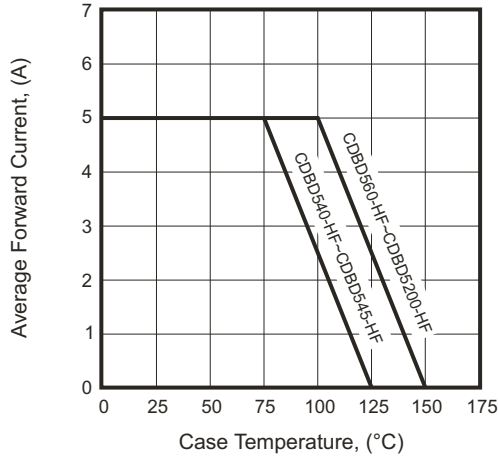

Fig.2 - Typical Forward Characteristics

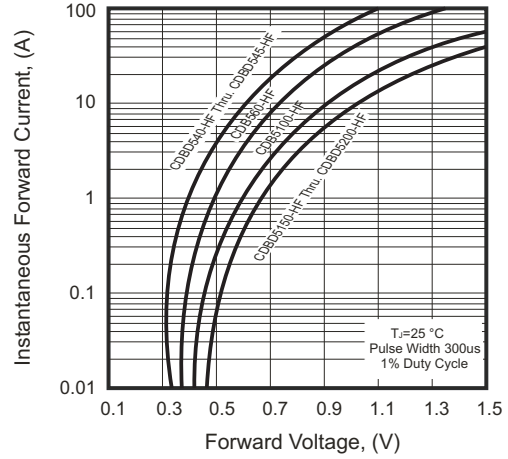

Fig.3 - Maximum Non-repetitive Forward Surge Current

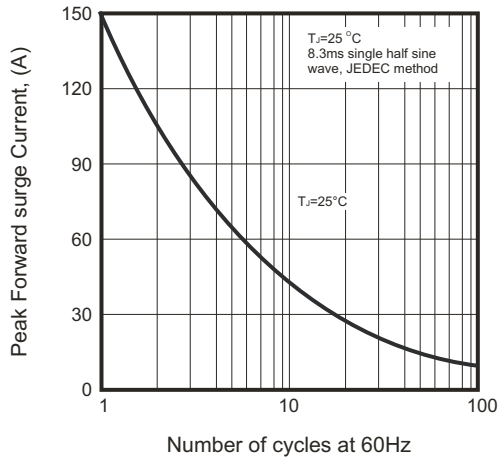
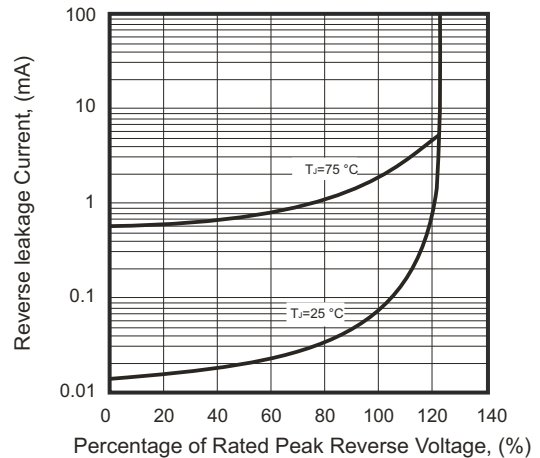
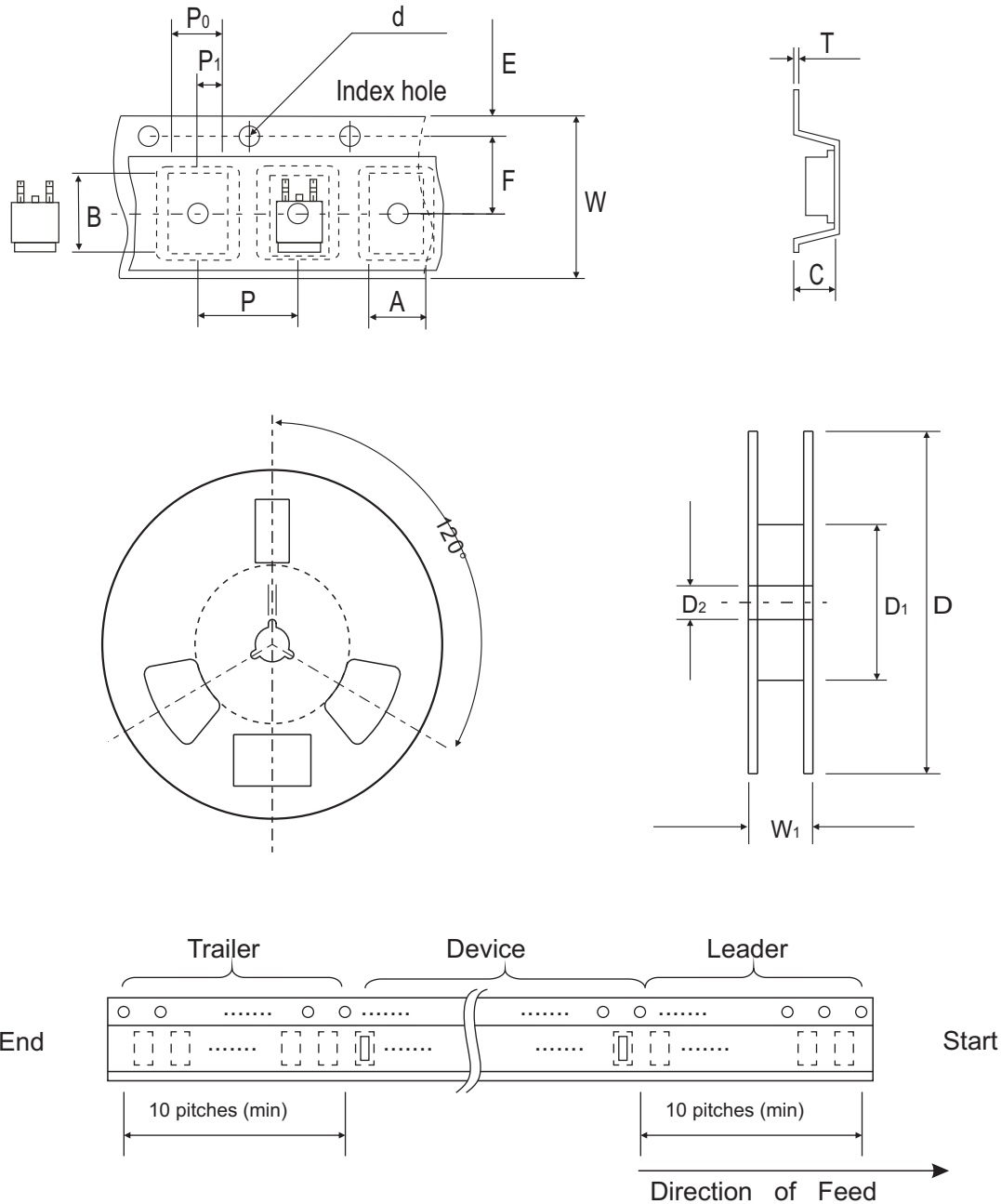

Fig.4 - Typical Reverse Characteristics



Reel Taping Specification



TO-252/DPAK	SYMBOL	A	B	C	d	D	D1	D2
	(mm)	6.90 ± 0.10	10.50 ± 0.10	2.70 ± 0.10	1.50 ± 0.10	330.00 ± 2.00	50.0 MIN.	13.0 ± 0.50
	(inch)	0.272 ± 0.004	0.413 ± 0.004	0.106 ± 0.004	0.059 ± 0.004	13.00 ± 0.079	1.969 MIN.	0.512 ± 0.020

TO-252/DPAK	SYMBOL	E	F	P	P0	P1	T	W	W1
	(mm)	1.75 ± 0.10	7.50 ± 0.10	8.00 ± 0.10	4.00 ± 0.10	2.00 ± 0.10	0.23 ± 0.10	16.00 ± 0.30	22.00 ± 1.0
	(inch)	0.069 ± 0.004	0.295 ± 0.004	0.315 ± 0.004	0.157 ± 0.004	0.079 ± 0.004	0.009 ± 0.004	0.630 ± 0.012	0.866 ± 0.039

Company reserves the right to improve product design, functions and reliability without notice.

REV:B

Marking Code

Part Number	Marking Code
CDBD540-HF	SK540Y
CDBD545-HF	SK545Y
CDBD560-HF	SK560Y
CDBD5100-HF	SK5100Y
CDBD5150-HF	SK5150Y
CDBD5200-HF	SK5200Y

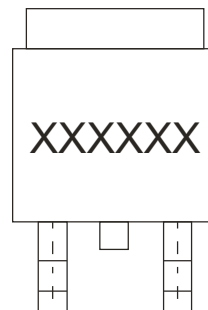

XXXXXX / XXXXXXXX = Product type marking code

Suggested PAD Layout

SIZE	TO-252 / DPAK	
	(mm)	(inch)
A	6.90	0.271
B	2.30	0.091
C	11.60	0.457
X1	7.00	0.276
X2	1.50	0.059
Y1	7.00	0.267
Y2	2.50	0.098

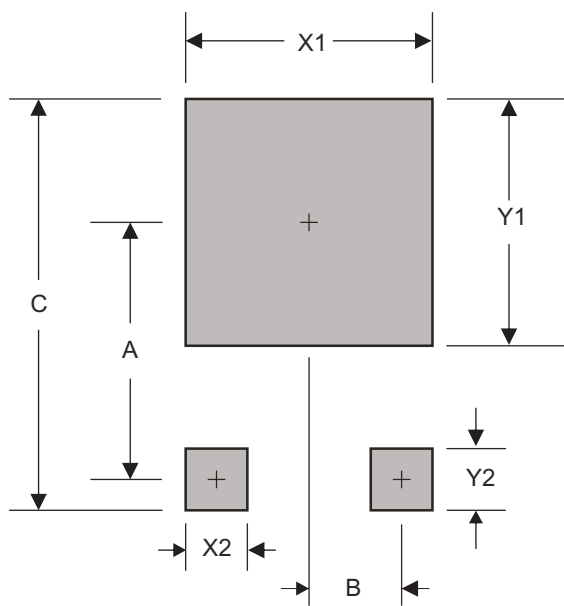

Standard Packaging

Case Type	REEL PACK	
	REEL (pcs)	Reel Size (inch)
TO-252/DPAK	3,000	13