

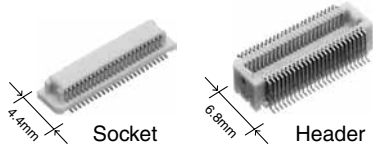

**Discontinued**  
Last time buy: August 31, 2012

# Panasonic

## ideas for life



RoHS compliant

For board-to-board

**Narrow pitch connectors  
(0.5mm pitch)**

# Floating type P5 Series

### FEATURES

1. The 0.5mm pitch stacking connector with a built-in floating mechanism.
2. Further reduction of equipment size is now possible.

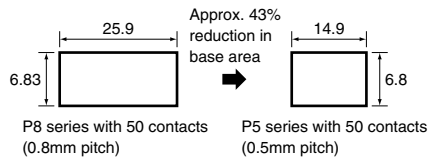

3. The original structure ensures higher reliability performance for both electrical and mechanical connections.

- Flux-creeping prevention structure (header)
  - Simple lock mechanism
4. **Automatic Mounting**
  5. **Porosity treatment applied for improved resistance against corrosion**

### APPLICATIONS

Small mobile equipment, such as mobile phones, PHSs, and PDAs

#### What is a floating structure?

The header is a two-piece structure that can absorb any variation caused when a connector (header and socket) is integrated into a printed circuit board. (When two sets of connectors are used as shown below, a maximum deviation of 0.3mm can be absorbed.)

#### • Floating structure

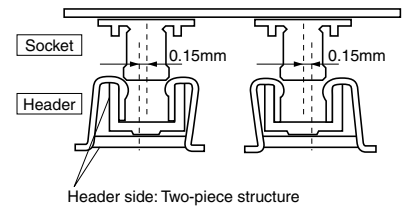

## ORDERING INFORMATION

AXN      **5** **G**

5: Narrow Pitch Connector P5 Floating type (0.5 mm pitch) Socket  
6: Narrow Pitch Connector P5 Floating type (0.5 mm pitch) Header

Number of pins (2 digits)

Mated direction / Mated height

<Socket>

0: For SMD vertical mating, mated height 5.0 mm

<Header>

5: For SMD vertical mating, mated height 5.0 mm

Functions

<Socket>

4: Without soldering terminals, without positioning bosses

<Header>

8: With floating function, without soldering terminals, without positioning bosses

Surface treatment (Contact portion / Terminal portion)

5: Ni plating on base, Au plating on surface / Ni plating on base, Au plating on surface

Packing

G: 1,000 pieces embossed tape and plastic reel × 2



**Discontinued**  
Last time buy: August 31, 2012

AXN(5/6)

## PRODUCT TYPES

Mated height	No. of pins	Part No.		Packing quantity	
		Socket	Header	Inner carton (1 reel)	Outer carton
5.0 mm	20	AXN520045G	AXN620585G	1,000 pcs.	2,000 pcs.
	30	AXN530045G	AXN630585G		
	40	AXN540045G	AXN640585G		
	50	AXN550045G	AXN650585G		
	60	AXN560045G	AXN660585G		
	80	AXN580045G	AXN680585G		
	100	AXN500045G	AXN600585G		

Note) Connectors are available in a standard embossed tape package (1,000 pcs/lot). Minimum ordering quantity is a single reel.

Samples for mounting confirmation: Available in units of 50 pieces. Please consult us. (See "Regarding sample orders to confirm proper mounting" on page 170.)  
Samples: Small lot orders for the above models are possible.

## SPECIFICATIONS

### 1. Characteristics

Item		Specifications	Conditions
Electrical characteristics	Rated current	0.2A	
	Rated voltage	60V AC/DC	
	Breakdown voltage	150V AC for 1 min.	Detection current: 1mA
	Insulation resistance	Min. 1000MΩ	Using 500V DC megger
	Contact resistance	Max. 80mΩ	Based on the contact resistance measurement method specified by JIS C 5402.
Mechanical characteristics	Composite insertion force	Max. 0.981N {100gf} × no. of pins (initial)	
	Composite removal force	Min. 0.0785N {8gf} × no. of pins	
	Contact holding force	Min. 2.94N {300gf}/2 pin contacts	Measuring the maximum force. As the contact is axially pull out.
Environmental characteristics	Ambient temperature	-55°C to +85°C	No freezing at low temperatures
	Soldering heat resistance	Max. peak temperature of 245°C (on the surface of the PC board around the connector terminals)	Infrared reflow soldering
		300°C within 5 seconds	Soldering iron
	Thermal shock resistance (header and socket mated)	5 cycles, insulation resistance min. 100MΩ, contact resistance max. 80mΩ	Sequence 1. -55 <sup>±3</sup> °C, 30 minutes 2. ~, Max. 5 minutes 3. 85 <sup>+3</sup> °C, 30 minutes 4. ~, Max. 5 minutes
	Humidity resistance (header and socket mated)	120 hours, insulation resistance min. 100MΩ, contact resistance max. 80mΩ	Bath temperature 40±2°C, humidity 90 to 95% R.H.
	Saltwater spray resistance (header and socket mated)	24 hours, insulation resistance min. 100MΩ, contact resistance max. 80mΩ	Bath temperature 35±2°C, saltwater concentration 5±1%
	H <sub>2</sub> S resistance (header and socket mated)	48 hours, contact resistance max. 80mΩ	Bath temperature 40±2°C, gas concentration 3±1 ppm, humidity 75 to 80% R.H.
	SO <sub>2</sub> resistance (header and socket mated)	48 hours, contact resistance max. 80mΩ	Bath temperature 40±2°C, gas concentration 10±3 ppm, humidity 90 to 95% R.H.
Lifetime characteristics	Insertion and removal life	20 times	Repeated insertion and removal speed of max. 200 times/hours
Unit weight		30 pin contacts; Socket: 0.19g Header: 0.32g 50 pin contacts; Socket: 0.29g Header: 0.50g	

### 2. Material and surface treatment

Part name	Material	Surface treatment
Molded portion	Heat-resistant resin (UL94V-0)	—
Contact/post	Copper alloy	Contact portion: Ni plating on base, Au plating on surface Terminal portion: Ni plating on base, Au plating on surface (Except for thick of terminal)

## DIMENSIONS (Unit: mm)

### • Socket



Dimension table (mm)

No. of pins	A	B
20	7.40	4.50
30	9.90	7.00
40	12.40	9.50
50	14.90	12.00
60	17.40	14.50
80	22.40	19.50
100	27.40	24.50

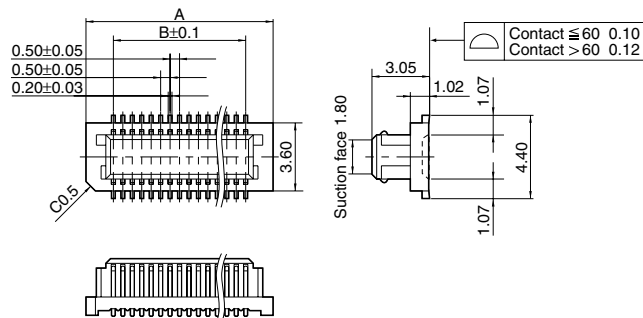

Recommended PC board pattern (TOP VIEW)

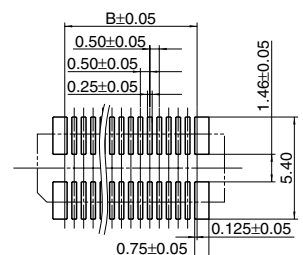

General tolerance: ±0.2

• Header



Dimension table (mm)

No. of pins	A	B
20	7.40	4.50
30	9.90	7.00
40	12.40	9.50
50	14.90	12.00
60	17.40	14.50
80	22.40	19.50
100	27.40	24.50

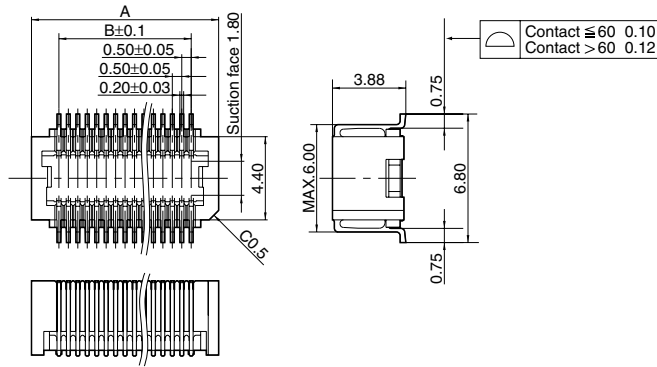

Recommended PC board pattern (TOP VIEW)

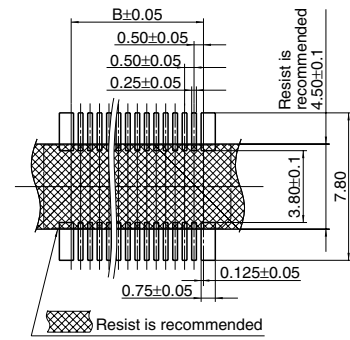

General tolerance: ±0.2

• Socket and Header are mated

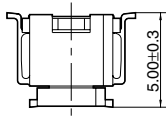

## EMBOSSED TAPE DIMENSIONS (unit: mm, Common for respective contact type, socket and header)

• Tape dimensions (Conforming to JIS C 0806-1990.

However, some tapes have mounting hole pitches that do not comply with the standard.)

• Plastic reel dimensions (Conforming to EIAJ ET-7200B)

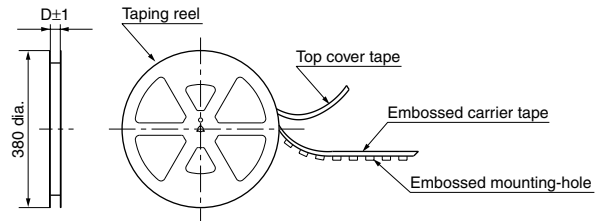
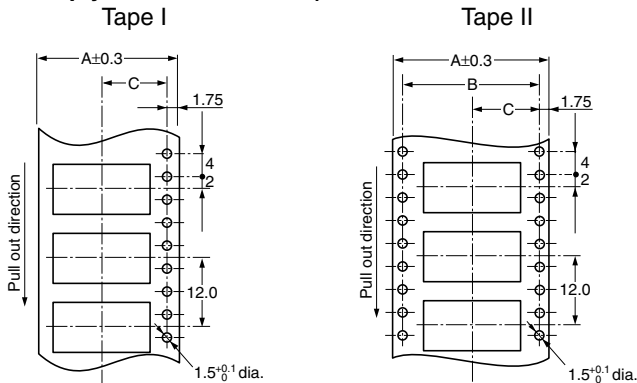

Dimension table (mm)

Mated height	No. of pins	Type of taping	A	B	C	D	Quantity per reel
Socket and header are common: 5.0mm	20 to 60	Tape I	24.0	—	11.5	25.4	1,000
	80	Tape II	32.0	28.4	14.2	33.4	1,000
	100	Tape II	44.0	40.4	20.2	45.4	1,000

### Connector orientation with respect to direction of progress of embossed tape

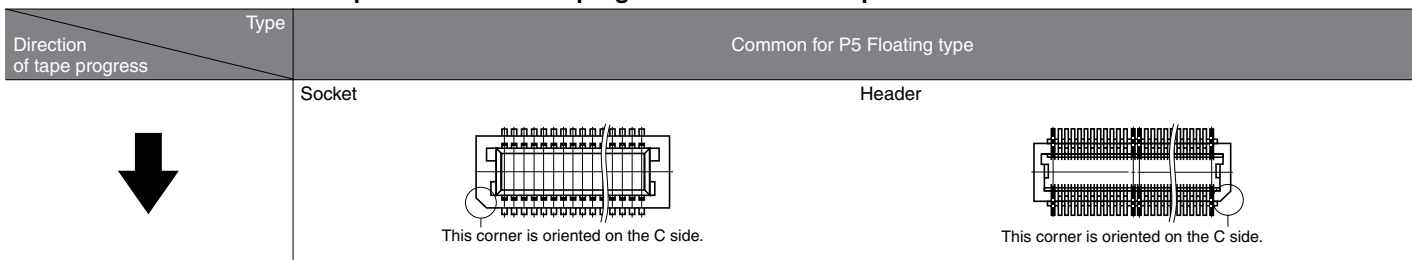



## NOTES

### 1. Preventing vibration and shock

To prevent the PC board from drop-off faults and to protect soldered spots from direct stress, use vibration-proof pads across boards.

Fix the PC boards in place or install a stopper so that the gap between the connectors is less than 0.5 mm and that their mating is level.

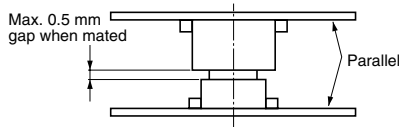

### 2. Prevention of reverse mating

The socket and header are protected from reverse mating by a molded resin key. Excessive mating force may damage the key, so be sure to match chamfered corners when mating.

### • Floating type

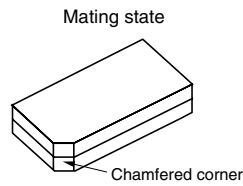

### 3. Static electricity

This type of socket has the terminals exposed from the connector walls, and therefore if they are touched with anything metal, a short circuit will occur. Also, if the terminals are touched by hand, the static electricity may damage the IC.

### 4. About floating-type connectors

(1) When two floating-type connectors are used on header, distance tolerance between connectors is 0.3mm max.

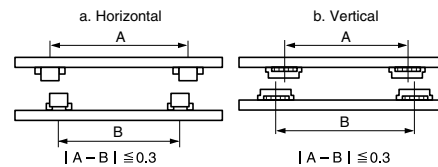

(2) If rotational error exists between two connectors, distance tolerance between the two connectors is as follows:

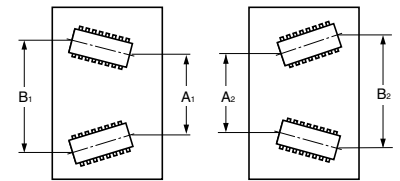

$$|A_1 - A_2| \leq 0.3$$

$$|B_1 - B_2| \leq 0.3$$

However, A1 is mated with A2, and B1 is mated with B2.

(3) Please consult us regarding allowable installation pitch tolerance between connectors when using two connectors that have differing number of terminals.

Please refer to the latest product specifications when designing your product.

# NOTES FOR USING SMD TYPE CONNECTORS (Common)

## Regarding the design of devices and PC board patterns

1) When connecting several connectors together by stacking, make sure to maintain proper accuracy in the design of structure and mounting equipment so that the connectors are not subjected to twisting and torsional forces.

2) With mounting equipment, there may be up to a  $\pm 0.2$  to 0.3-mm error in positioning. Be sure to design PC boards and patterns while taking into consideration the performance and abilities of the required equipment.

3) Some connectors have tabs embossed on the body to aid in positioning. When using these connectors, make sure that the PC board is designed with positioning holes to match these tabs.

4) To ensure the required mechanical strength when soldering the connector terminals, make sure the PC board meets recommended PC board pattern design dimensions given.

5) For all connectors of the narrow-pitch series, to prevent the PC board from coming off during vibrations or impacts, and to prevent loads from falling directly on the soldered portions, be sure to design some means to fix the PC board in place.

### Example) Secure in place with screws

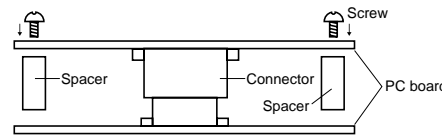

When connecting PC boards, take appropriate measures to prevent the connector from coming off.

6) Notes when using a FPC.

(1) When the connector is soldered to an FPC board, during its insertion and removal procedures, forces may be applied to the terminals and cause the soldering to come off. It is recommended to use a reinforcement board on the backside of the FPC board to which the connector is being connected. Please make the reinforcement board dimensions bigger than the outer limits of the recommended PC board pattern (should be approximately 1 mm greater than the outer limit).

Material should be glass epoxy or polyimide, and the thickness should be between 0.2 and 0.3 mm.

(2) Collisions, impacts, or turning of FPC boards, may apply forces on the

connector and cause it to come loose.

Therefore, make to design retaining plates or screws that will fix the connector in place.

7) The narrow-pitch connector series is designed to be compact and thin.

Although ease of handling has been taken into account, take care when mating the connectors, as displacement or angled mating could damage or deform the connector.

## Regarding the selection of the connector placement machine and the mounting procedures

1) Select the placement machine taking into consideration the connector height, required positioning accuracy, and packaging conditions.

2) Be aware that if the catching force of the placement machine is too great, it may deform the shape of the connector body or connector terminals.

3) Be aware that during mounting, external forces may be applied to the connector contact surfaces and terminals and cause deformations.

4) Depending on the size of the connector being used, self alignment may not be possible. In such cases, be sure to carefully position the terminal with the PC board pattern.

5) The positioning bosses give an approximate alignment for positioning on the PC board. For accurate positioning of the connector when mounting it to the PC board, we recommend using an automatic positioning machine.

# NOTES FOR USING SMD TYPE CONNECTORS (Common)

## Regarding soldering

### 1. Reflow soldering

- 1) Measure the recommended profile temperature for reflow soldering by placing a sensor on the PC board near the connector surface or terminals. (The setting for the sensor will differ depending on the sensor used, so be sure to carefully read the instructions that comes with it.)
- 2) As for cream solder printing, screen printing is recommended.
- 3) See the specifications and drawings for the product in question for the metal mask pattern diagrams.
- 4) When mounting on both sides of the PC board and the connector is mounting on the underside, use adhesives or other means to ensure the connector is properly fixed to the PC board. (Double reflow soldering on the same side is possible.)
- 5) N<sub>2</sub> reflow, conducting reflow soldering in a nitrogen atmosphere, increases the solder flow too greatly, enabling wicking to occur. Make sure that the solder feed rate and temperature profile are appropriate.

### Soldering conditions

Please use the reflow temperature profile conditions recommended below for reflow soldering. Please contact us before using a temperature profile other than that described below (e.g. lead-free solder).

- Narrow-pitch connectors (except P5 floating and P8 type)

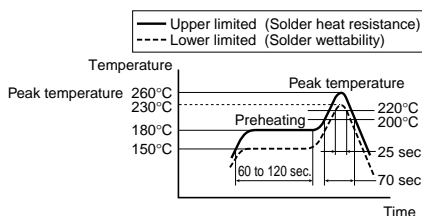

- Narrow-pitch connector (P5 floating, P8)

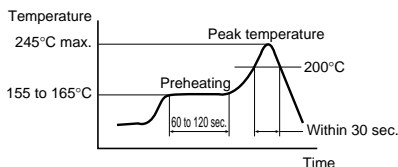

- For products other than the ones above, please refer to the latest product specifications.
- 6) The temperatures are measured at the surface of the PC board near the connector terminals. (The setting for the sensor will differ depending on the sensor used, so be sure to carefully read the instructions that comes with it.)
  - 7) The temperature profiles given in this catalog are values measured when using the connector on a resin-based PC board. When performed reflow soldering on a metal board (iron, aluminum, etc.) or a metal table to mount on a FPC, make sure there is no deformation or discoloration of the connector beforehand and then begin mounting.

### 2. Hand soldering

- 1) Set the soldering iron so that the tip temperature is less than that given in the table below.

Table A

Product name	Soldering iron temperature
SMD type connectors	300°C within 5 sec. 350°C within 3 sec.

- 2) Do not allow flux to spread onto the connector leads or PC board. This may lead to flux rising up to the connector inside.
- 3) Touch the soldering iron to the foot pattern. After the foot pattern and connector terminal are heated, apply the solder wire so it melts at the end of the connector terminals.

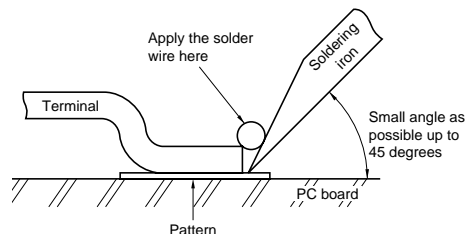

- 4) Be aware that soldering while applying a load on the connector terminals may cause improper operation of the connector.
- 5) Thoroughly clean the soldering iron.
- 6) Flux from the solder wire may get on the contact surfaces during soldering operations. After soldering, carefully check the contact surfaces and clean off any solder before use.
- 7) For soldering of prototype devices during product development, you can perform soldering at the necessary locations by heating with a hot-air gun by applying cream solder to the foot pattern beforehand. However, at this time, make sure that the air pressure does not move connectors by carefully holding them down with tweezers or other similar tool. Also, be careful not to go too close to the connectors and melt any of the molded components.

### 3. Solder reworking

- 1) Finish reworking in one operation.
- 2) For reworking of the solder bridge, use a soldering iron with a flat tip. To prevent flux from climbing up to the contact surfaces, do not add more flux.
- 3) Keep the soldering iron tip temperature below the temperature given in Table A.

# NOTES FOR USING SMD TYPE CONNECTORS (Common)

## Handling Single Components

- 1) Make sure not to drop or allow parts to fall from work bench
- 2) Excessive force applied to the terminals could cause warping, come out, or weaken the adhesive strength of the solder. Handle with care.
- 3) Repeated bending of the terminals may cause terminals to break.
- 4) Do not use alcohol for cleaning. Doing so may whiten the surface of molded parts.

## Cleaning flux from PC board

- 1) To increase the cleanliness of the cleaning fluid and cleaning operations, prepare equipment for cleaning process beginning with boil cleaning, ultrasonic cleaning, and then vapor cleaning.
- 2) Carefully oversee the cleanliness of the cleaning fluids to make sure that the contact surfaces do not become dirty from the cleaning fluid itself.
- 3) Since some powerful cleaning solutions may dissolve molded components of the connector and wipe off or discolor printed letters, we recommend aqua pura electronic parts cleaners. Please consult us if you wish to use other types of cleaning fluids.
- 4) Please note that the surfaces of molded parts may whiten when cleaned with alcohol.

## Handling the PC board

### • Handling the PC board after mounting the connector

When cutting or bending the PC board after mounting the connector, be careful that the soldered sections are subjected to excessive forces.

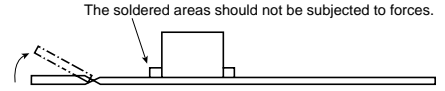

## Storage of connectors

- 1) To prevent problems from voids or air pockets due to heat of reflow soldering, avoid storing the connectors in areas of high humidity. When storing the connectors for more than six months, be sure to consider storage area where the humidity is properly controlled.
- 2) Depending on the connector type, the color of the connector may vary from connector to connector depending on when it is produced.

Some connectors may change color slightly if subjected to ultraviolet rays during storage. This is normal and will not affect the operation of the connector.

- 3) When storing the connectors with the PC boards assembled and components already set, be careful not to stack them up so the connectors are subjected to excessive forces.

- 4) Avoid storing the connectors in locations with excessive dust. The dust may accumulate and cause improper connections at the contact surfaces.

## Other Notes

- 1) These products are made for the design of compact and lightweight devices and therefore the thickness of the molded components has been made very thin. Therefore, be careful during insertion and removal operations for excessive forces applied may damage the products.
- 2) Dropping of the products or rough mishandling may bend or damage the terminals and possibly hinder proper reflow soldering.

- 3) Before soldering, try not to insert or remove the connector more than absolutely necessary.
- 4) When coating the PC board after soldering the connector to prevent the deterioration of insulation, perform the coating in such a way so that the coating does not get on the connector.
- 5) There may be variations in the colors of products from different production lots. This is normal.

- 6) The connectors are not meant to be used for switching.
- 7) Be sure not to allow external pressure to act on connectors when assembling PCBs or moving in block assemblies.

## Regarding sample orders to confirm proper mounting

When ordering samples to confirm proper mounting with the placement machine, connectors are delivered in 50-piece units in the condition given right. Consult a sale representative for ordering sample units.

Condition when delivered from manufacturing



Embossed tape amount required for the mounting

Required number of products for sample production (Unit 50 pcs.)

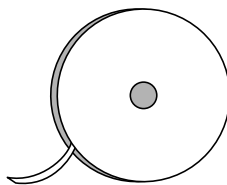

Reel

(Delivery can also be made on a reel by customer request.)

Please refer to the latest product specifications when designing your product.