

# FC SERIES RATIO SETTER

DATA SHEET

PMG

The FC SERIES ratio setter is an instrument to feed ratio setting signals to a controller. It is equipped with a solid state indicator and pushbutton operating mechanism to provide easy monitoring and operation and dependable performance.

## SPECIFICATIONS

### 1. Operation formula and input signal

Operation formula:

$$SO = K (PV - B1) + B2$$

SO: Output signal  
 K: Ratio set value  
 PV: Input signal  
 B1: Input side bias  
 B2: Output side bias

Ratio setting range:

$$2 \cong K_{max} - K_{min} > 0$$

$$\left[ \begin{array}{l} 4 \cong K_{max} > 0 \\ 2 \cong K_{min} > 0 \end{array} \right]$$

Bias setting range:

B1 and B2 .... 0 - 100%

Input signal: 1-5V DC

Setting command signal:

1- 5V DC, pulse width signal, pulse number signal

Function selecting signal:

ON/OFF signal

Signal rating: 1-5V DC

Input impedance; more than 500kΩ  
(33kΩ at range over)

Input filter time constant; 33 ms

Pulse width signal, pulse number signal, and ON/OFF signal

With signal; 0V/-2.5mA DC

Without signal; 24V/+3mA DC

Output signal (SO):

1-5V DC

Internal impedance, less than 0.5Ω

Allowable load current; ±3mA

Set value (K) output signal:

1-5V DC

Internal impedance; less than 0.5Ω

Allowable load current; ±3mA

Status indication output:

Request remote

Local - status

Contact; transistor contact

Output ration; Max. 30V DC , 0.1A

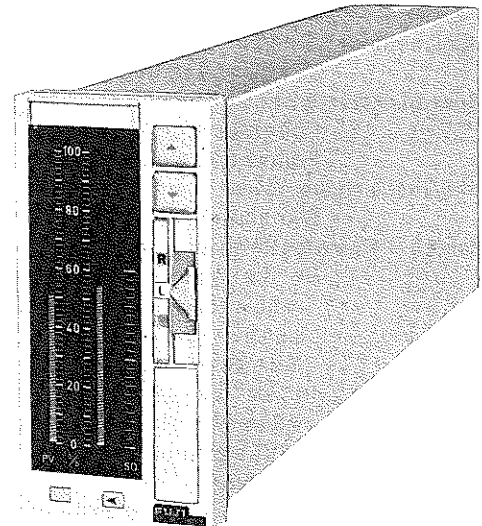

### 2. Indicating Functions

#### Process variable input and set point variable indicators

Indicating method:

Plasma display (orange)

Number of indicating segments:

201

Indicating range: 0-100%, linear

Indication resolution:

0.5% of full scale

Scale length:

100 mm

#### Output indicator

Indicating method:

Light emitting diode (red)

Number of indicating segments:

23

Indicating range: 0-100%, linear

Indication resolution:

2.5% of full scale

Scale length:

60 mm



(Note) By pressing the change button , output signal is indicated accurately on the plasma display (set value indicator).

**Status indication**

Indicating lamp: Local (L); L lamp (green) ON  
Remote (R); R lamp (green) ON

**3. Setting Functions**

**Local setting**

Setting method: Manual setting  
Front panel pushbutton   system,  
travel time 40s/FS

**Cascade voltage setting**

Setting method: External setting with 1–5V DC signal,  
and manual setting

Follow-up characteristic:  
Follow-up speed 2.5s/FS,  
Follow-up accuracy  $\pm 0.5\%$  FS

Setting mode change lever:  
R (remote) – L (local)

**Local (L) – Remote (R) changeover**  
In the remote mode, the local set value follows the external setting signal  
Balanceless, bumpless changeover  
In the local mode, the external set value is indicated on the set value (SV) indicator by pressing the balance button.   
Correct and change the local set value manually  
Balance, bumpless changeover

Set value output signal:  
1–5V DC

Output contact signal:  
RR (request, remote); at request for remote  
L (local); local setting

Operation status indication:  
Indicated by lamps (R, L) on front

**Cascade/pulse width setting**

Setting method: External setting with increased and decreased pulse width, and manual setting.

Follow-up characteristic:  
Follow-up speed; 10s/FS,  
Minimum detectable pulse width; 10ms

Setting mode change lever:  
R (remote) – L (local)

**Local (L) – Remote (R) changeover:**  
Balanceless bumpless changeover for both; local (L)  $\rightleftarrows$  remote (R)

Set value output signal:  
1–5V DC

Output contact signal:  
RR (request, remote): at request for remote  
L (local): local setting

**Cascade/pulse number setting**

Setting method: External setting with increased and decreased number of pulses, and manual setting.

**Follow-up characteristic:**

Number of pulses for full scale travel;  
1000 pulses/FS  
Pulse width; more than 5ms,  
Pulse interval; less than 100pps

**Setting mode change lever:**

R (remote) – L (local)

**Local (L) – Remote (R) changeover:**

Balanceless, bumpless changeover for both; local (L)  $\rightleftarrows$  remote (R)

**Set value output signal:**

1–5V DC

**Output contact signal:**

RR (request, remote): at request for remote  
L (local): local setting

**4. Operating Conditions and others**

Power supply: 24V (20–30V) DC  
or 100V AC, 50/60 Hz

Power consumption:  
Approx. 7W (24V DC)  
or 10VA (100V AC)

Allowable instantaneous power interruption time:  
DC power; 1ms,  
AC power; 30ms  
Battery backup power supply is available.

Memory contents holding time:  
Set value and output value; TYP 30min.  
When the memory data are cleared due to a long power failure, the set value and output value are started from the preset level (preset level setting unit is built in).

Dielectric strength:  
500V AC, 1 min. (DC power supply)  
or 1000V AC, 1 min. (AC power supply)

Insulation resistance:  
More than 100M $\Omega$  at 500V DC

Ambient temperature:  
0 – 45 $^{\circ}$ C

Ambient humidity:  
Less than 90% RH

Enclosure: Steel case

Dimensions (HxWxD):  
144x72x400 mm, IEC (DIN) standards

Weight: Approx. 4.5 kg

Finish color: Munsell 7Y 7.3/1.4 (case and front panel)

Delivery range: Ratio setter, mounting bracket

Mounting method:  
Flush mounting on panel  
Standard; vertical mounting  
Nonstandard; inclined mounting

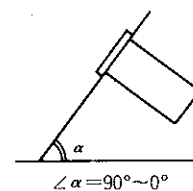

# CODE SYMBOLS

1	2	3	4	5	6	7	8	Description
P	M	G	0	0			3	<b>Setting system</b>
	1							Manual setting
	3							Cascade voltage setting
	4							Cascade pulse width setting
	5							Cascade pulse number setting
								<b>Power supply</b>
		1						24V DC
		3						100V AC 50/60 Hz

## OUTLINE DIAGRAM (Unit:mm)

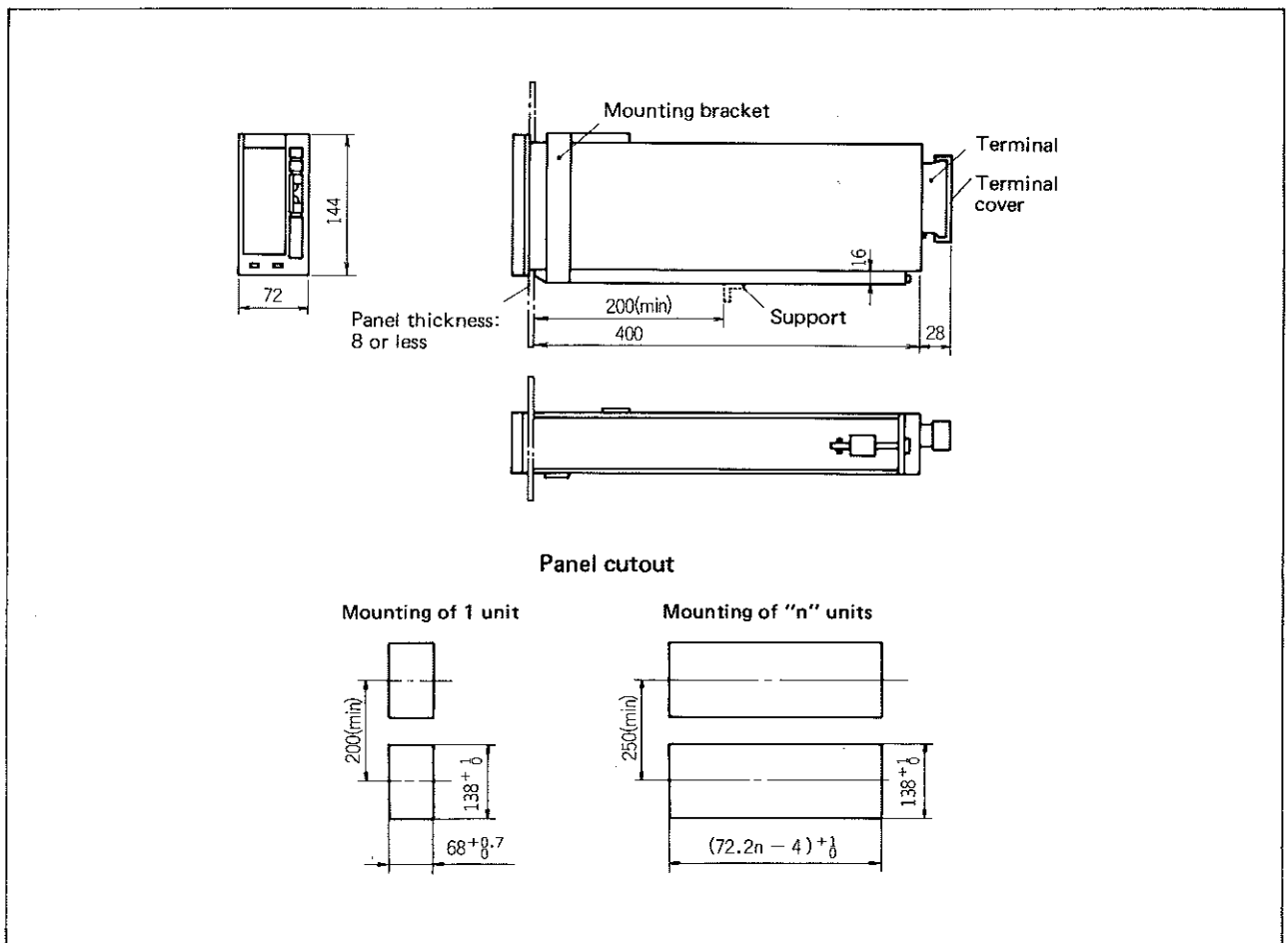

CONNECTION DIAGRAM

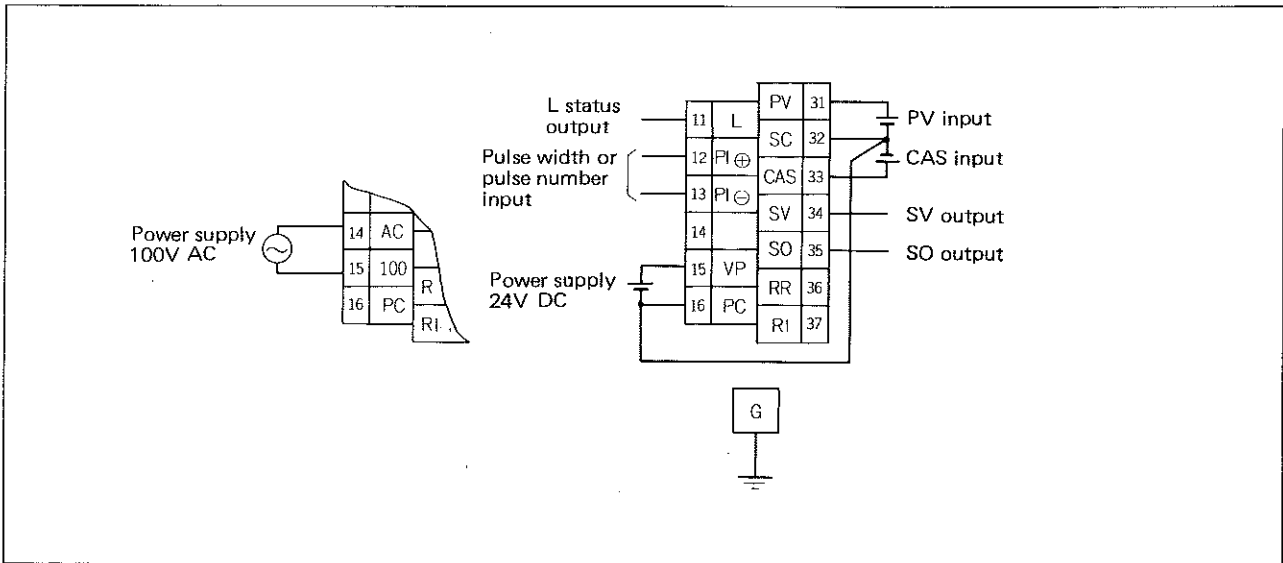

• Asterisked (\*) items; Non-standard.

**Fuji Electric Co.,Ltd.**

12-1 Yurakucho 1-chome, Chiyoda-ku, Tokyo, 100 Japan  
 Phone: Tokyo 3211-7111  
 Telex: J22331 FUJIELEA or FUJIELEB