



ON Semiconductor®

<http://onsemi.com>

APPLICATION NOTE

Thermal Considerations for the ON Semiconductor Family of Discrete Constant Current Regulators (CCR) for Driving LEDs in Automotive Applications

Prepared by: Mike Sweador (AE),
David Helzer (PE)
ON Semiconductor

Introduction

The ON Semiconductor Constant Current Regulator (CCR) family of devices offer outstanding regulation for LEDs and other current based loads, such as battery charging circuits. The CCR reduces the complexity of resistor biased designs for sensitive loads, such as LED strings connected in series. The CCR can also be connected in parallel for higher load current applications. The two-terminal CCR requires no external components to regulate at the specified current. These devices can be used wherever a constant current is needed to maintain luminosity under varying voltage conditions.

See application note AND8349/D for basic circuit considerations.

The purpose of this paper is to explore the temperature and power boundaries for devices in the SOD-123 and SOT-223 packages operating from typical currents of 20 mA to 30 mA in automotive applications. The SOD-123 devices available are rated at 20 mA, 25 mA, and 30 mA. The SOT-223 devices are rated at 25 mA and 30 mA. See Appendix A for device list.

Reference to Datasheet

The datasheet describes the devices and defines the following terms that will be used throughout this note:

V_{AK} = Voltage applied between the Anode and Cathode of the device.

$$V_{\text{overhead}} = V_{\text{IN}} - V_{\text{LEDs}}$$

$I_{\text{reg(SS)}}$ = The current through the device supplied to the LEDs under steady-state operating conditions (device on ≥ 10 sec)

$I_{\text{reg(P)}}$ = The current through the device supplied to the LEDs under pulse test conditions (≤ 300 μ sec).

V_R = Reverse Voltage

P_D = Device power dissipation, typically in mW.

T_A = Ambient Temperature in $^{\circ}\text{C}$

T_J = Device Junction Temperature in $^{\circ}\text{C}$

The SOD-123 and SOT-223 Datasheet Thermal Characteristics table lists the thermal performance of each device as related to the heat spreader area and thickness. These datasheet tables and curves show thermal specifications and limits with the device junction temperature (T_J) operating at 150°C , the maximum allowable continuous junction temperature.

Operating at $T_{J\text{max}}$ continuously is not recommended for long term reliability.

Figure 1 shows power dissipation over changes in ambient temperature for the SOD-123 package. Figure 2 shows θ_{JA} ($^{\circ}\text{C}/\text{W}$) and P_D (W) for various Cu areas and thicknesses. These tables and graphs illustrate the effect of Cu area, thickness and ambient temperature (T_A) over the range of -40°C to 85°C , which encompasses the area of interest for automotive LED operation. LED data sheets show an extreme reduction in luminosity above 85°C T_A .

AND8391/D

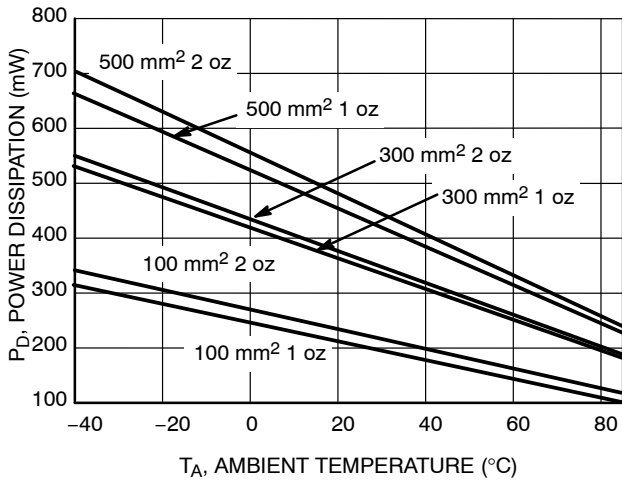

P_D max @ 85°C

500 mm ² 2 oz Cu	241 mW
500 mm ² 1 oz Cu	228 mW
300 mm ² 2 oz Cu	189 mW
300 mm ² 1 oz Cu	182 mW
100 mm ² 2 oz Cu	117 mW
100 mm ² 1 oz Cu	108 mW

Figure 1. Power Dissipation vs. Ambient Temperature (SOD-123) @ $T_J = 150^\circ\text{C}$ for Variable Copper Heat Spreader

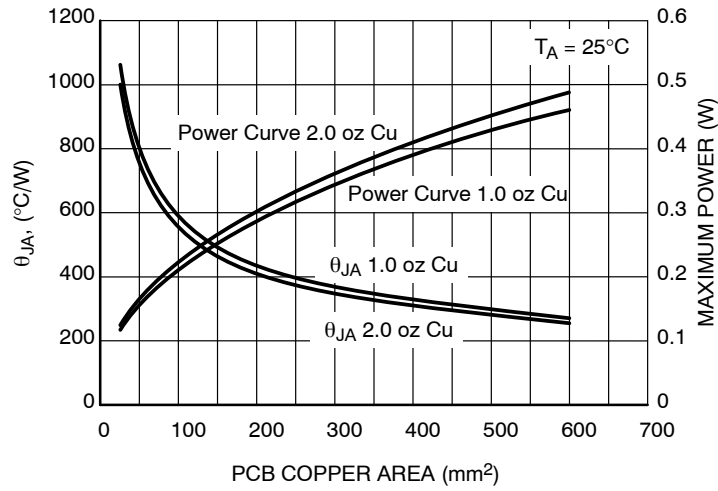

Figure 2. SOD-123 NSI14030T1G θ_{JA} and P_D vs. Cu Area

Figure 3 shows power dissipation over changes in ambient temperature for the SOT-223 package. Figure 4 shows θ_{JA} ($^{\circ}\text{C}/\text{W}$) and P_D (W) for various Cu areas and thicknesses. These tables and graphs illustrate the effect of Cu area, thickness and ambient temperature (T_A) over the range of -40°C to 85°C which encompasses the area of interest for automotive LED operation.

NOTE: 300 mm^2 2 oz Cu area has better thermal performance than 500 mm^2 1 oz Cu for this package.

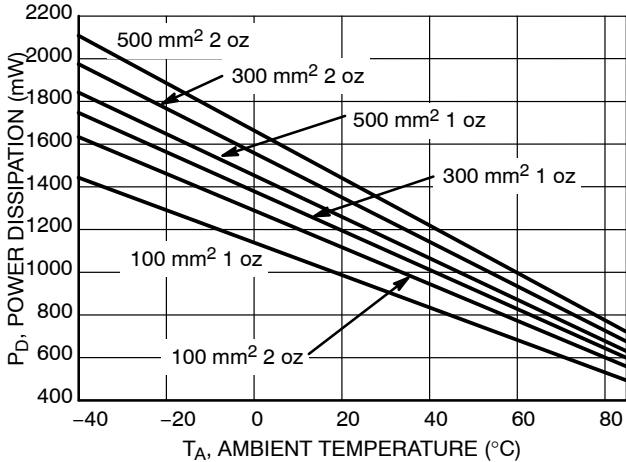

Figure 3. Power Dissipation vs. Ambient Temperature (SOT-223) @ $T_J = 150^{\circ}\text{C}$

P_D max @ 85°C

500 mm ² 2 oz Cu	722 mW
300 mm ² 2 oz Cu	676 mW
500 mm ² 1 oz Cu	631 mW
300 mm ² 1 oz Cu	598 mW
100 mm ² 2 oz Cu	559 mW
100 mm ² 1 oz Cu	494 mW

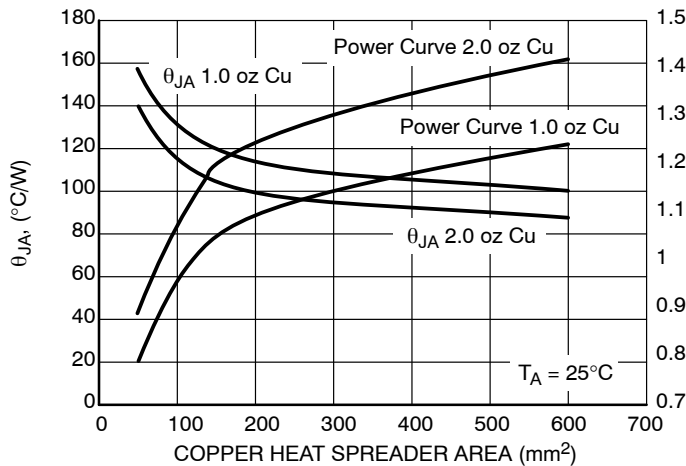

Figure 4. SOT-223 θ_{JA} and P_D vs. Cu Area

PC board design and the use of multilayer board material will affect the thermal performance. See ON Semiconductor application notes AND8220/D and AND8222/D for further information.

Ambient operating temperature (T_A) and estimated device power will help determine which package to use.

Figures 2 and 4 can be used to quickly determine which package and heat sink is a good candidate for the application.

Current Regulation: Pulse Mode vs. Steady-State

NOTE: All curves are based upon a typical 30 mA CCR device.

There are two methods of measuring current regulation: Pulse mode ($I_{reg(P)}$) testing is applicable for factory and

incoming inspection of a CCR where the test times are a minimum ($t \leq 300\ \mu\text{s}$). DC steady-state ($I_{reg(SS)}$) testing is applicable for application verification where the CCR will be operational for seconds, minutes or hours. ON Semiconductor has correlated the difference in $I_{reg(P)}$ to $I_{reg(SS)}$ for stated board material, size, copper area and copper thickness. $I_{reg(P)}$ will always be greater than $I_{reg(SS)}$ due to the die temperature rising during $I_{reg(SS)}$. This heating effect can be minimized during circuit design with the correct selection of board material, metal trace size and weight for the operating current, voltage, and board operating temperature (T_A) and package. (Refer to the Thermal Characteristics table in datasheet).

The curves of Figure 5 for the SOD-123 and Figure 6 for the SOT-223 packages show the relationship between I_{reg}

and time. I_{reg} decreases with time due to the effect of power on the die.

I_{reg} vs. TIME

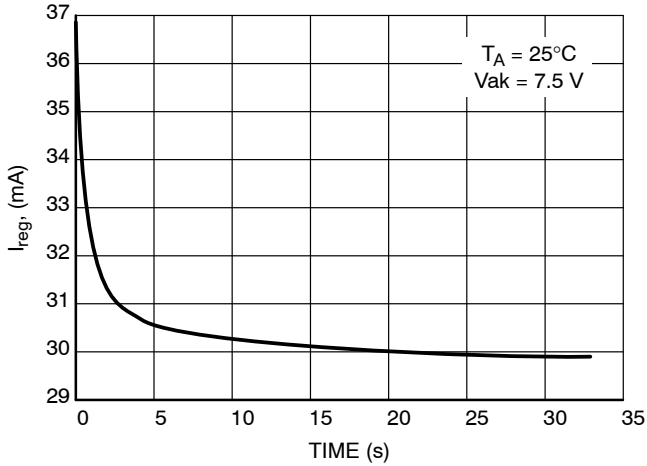

Figure 5. Typical SOD-123 30 mA, 300 mm², 1 oz Cu, In Still Air

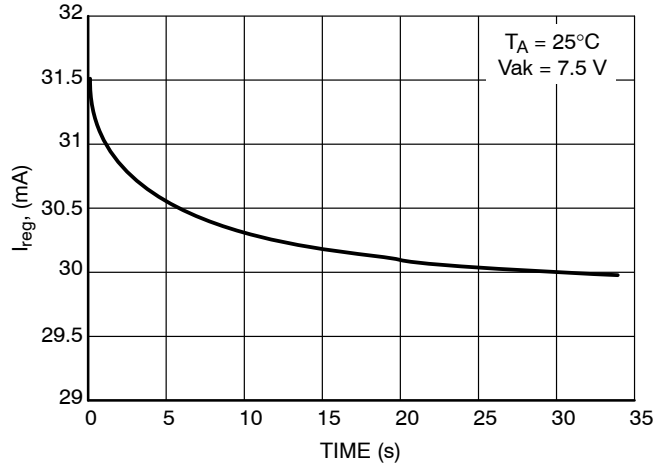

Figure 6. Typical SOT-223 30 mA, 300 mm², 2 oz Cu, In Still Air

Correlation studies show that for each package steady state I_{reg} there is a corresponding Pulsed I_{reg} value. Notice on these two-terminal devices that the SOT-223 $I_{reg(P)}$ has a lower value than the SOD-123 $I_{reg(P)}$, which results in $I_{reg(SS)}$ of 30 mA. This is due to the better $R_{\theta JA}$ of the

SOT-223. See Figures 7 and 8. The slope of the line in Figures 7 and 8 will change if the actual footprint and board thermal properties differ from the footprint listed in the figures.

STEADY STATE CURRENT ($I_{reg(SS)}$) vs. V_{ak} @ 30 mA

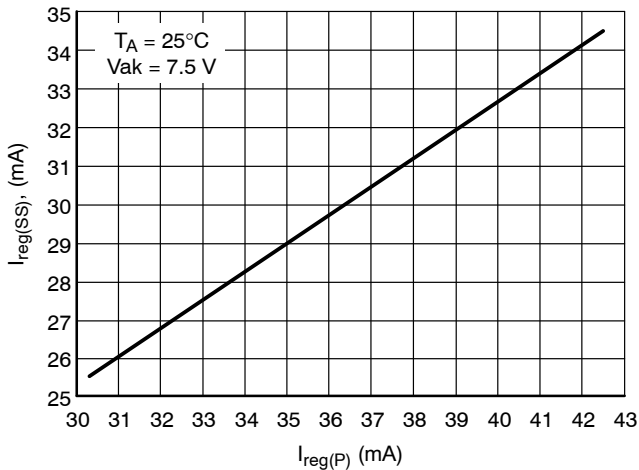

Figure 7. $I_{reg(SS)}$ vs. $I_{reg(P)}$ Testing SOD-123, 300 mm², 1 oz Cu, In Still Air

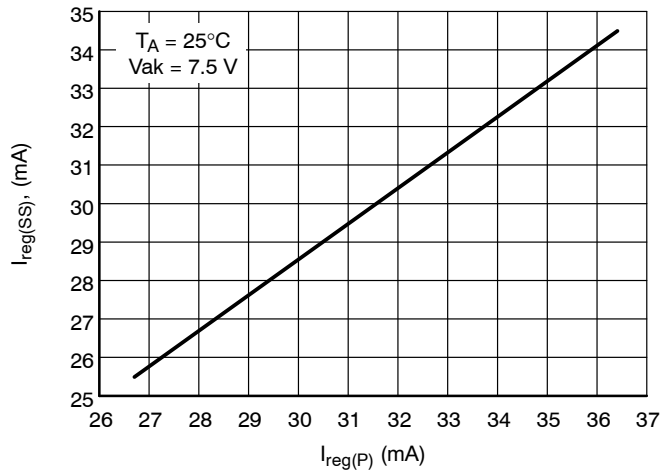

Figure 8. $I_{reg(SS)}$ vs. $I_{reg(P)}$ Testing SOT-223, 300 mm², 2 oz Cu, In Still Air

The negative temperature coefficient trend of a SOD-123 CCR has a benefit as it avoids thermal runaway. There are two areas of interest on the curves of Figure 9. The first is for a given T_A . Each curve shows a decrease in $I_{reg(SS)}$ as V_{ak} increases and therefore P_D increases. There also is the ambient temperature affect on I_{reg} for a fixed V_{ak} condition. Both the SOD-123 (Figure 9) and SOT-223 (Figure 10) show a decrease in $I_{reg(SS)}$ as T_A increases.

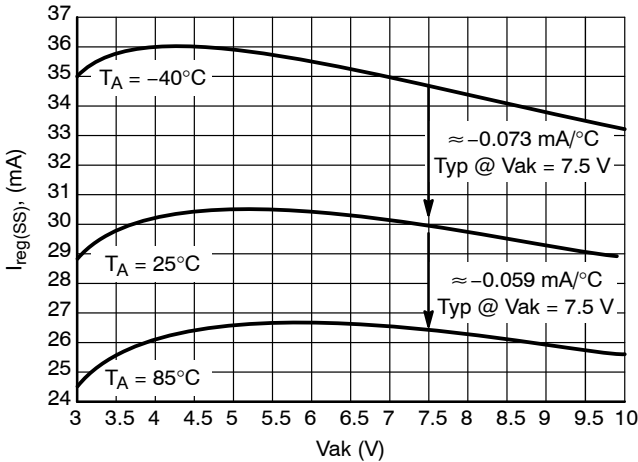

Figure 9. Typical SOD-123 30 mA, 300 mm², 1 oz Cu, In Still Air

The following design examples will show how to determine which package device and the Cu needed for a simple circuit.

Circuit Design

Example 1:

For a series circuit (Figure 11), the power dissipation of the CCR is determined by:

$(V_{source} - (V_{LEDS} + V_{RPD})) \times I_{reg}$. Using the worst case scenario; i.e, highest V_{source} , Lowest LED V_F , and highest target I_{reg} . Using a 16 V source (auto voltage regulator high output) driving two white LEDs with a V_f of 4.2 V, a reverse protection diode (RPD) with a V_F of 0.2 V and 30 mA I_{reg} would give: $(16 V - (2 \times 4.2 V + 0.2 V)) \times 0.030 A = 7.4 V \times 0.03 A = 222 mW$.

For an ambient temperature of 85°C, from the P_D curves of Figures 1 and 3 a SOD-123 with 500 mm² 1 oz Cu would

See ON Semiconductor application note AND8223/D for additional information.

SOD-123 devices exhibit a greater negative temperature coefficient as shown in Figure 9 than corresponding SOT-223 devices as shown in Figure 10, due to the difference in the package $R_{\theta JA}$. The SOD-123 package reaches thermal saturation with less power applied than the SOT-223 package.

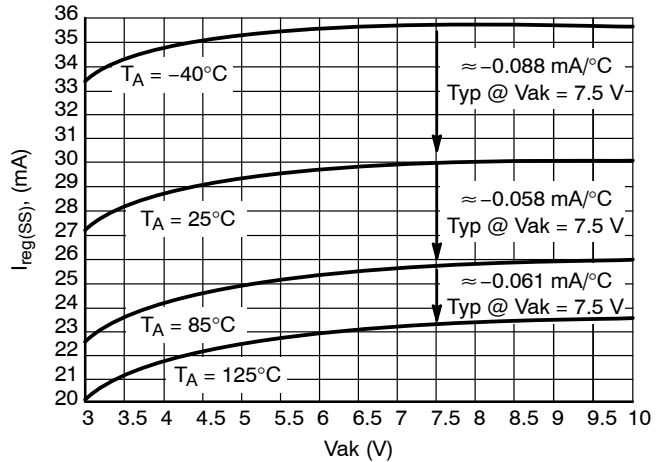

Figure 10. Typical SOT-223 30 mA, 300 mm², 2 oz Cu, In Still Air

suffice. A SOT-223 with 100 mm² 1 oz Cu would also work.

Example 2:

Three Red LEDs with each having a V_F of 2.0 Vdc @ 30 mA. Automotive battery voltage of 16 Vdc. Ambient temperature max of 85°C. Available heat sink area for device is 300 mm² of 1 oz Cu.

P_D of device = $(16 Vdc - (3 \times 2.0 Vdc) + 0.2 Vdc) \times 30 mA = 294 mW$

SOD-123 P_D max @ 85°C, 300 mm² of 1 oz Cu = 182 mW

SOT-223 P_D max @ 85°C, 300 mm² of 1 oz Cu = 598 mW

The SOT-223 gives a margin of safety in the application.

Or, knowing that 294 mW of power needs to be dissipated, we can select a SOT-223 device using 100 mm² of 1 oz Cu.

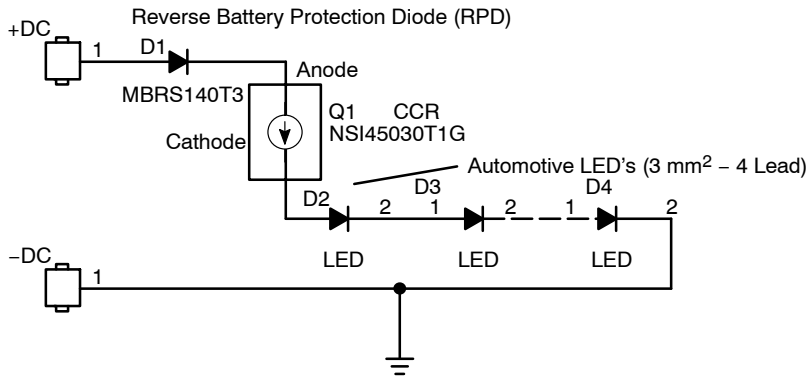

Figure 11.

AND8391/D

The following graphs show the relationship between $I_{reg(SS)}$ and T_A for both the SOD-123 and SOT-223 for a stated Cu area and thickness in still air. They also give the slope of the line which can be used to estimate T_J at a specific T_A .

The formula for estimating T_J is: $T_J = (P_D \times R_{\theta JA}) + T_A$ ($R_{\theta JA}$ value from datasheet)

For the SOD-123 @ 25°C, $T_J = (225 \text{ mW} \times 360^\circ\text{C/W}) + 25^\circ\text{C} = 106^\circ\text{C}$ (as shown on the graph).

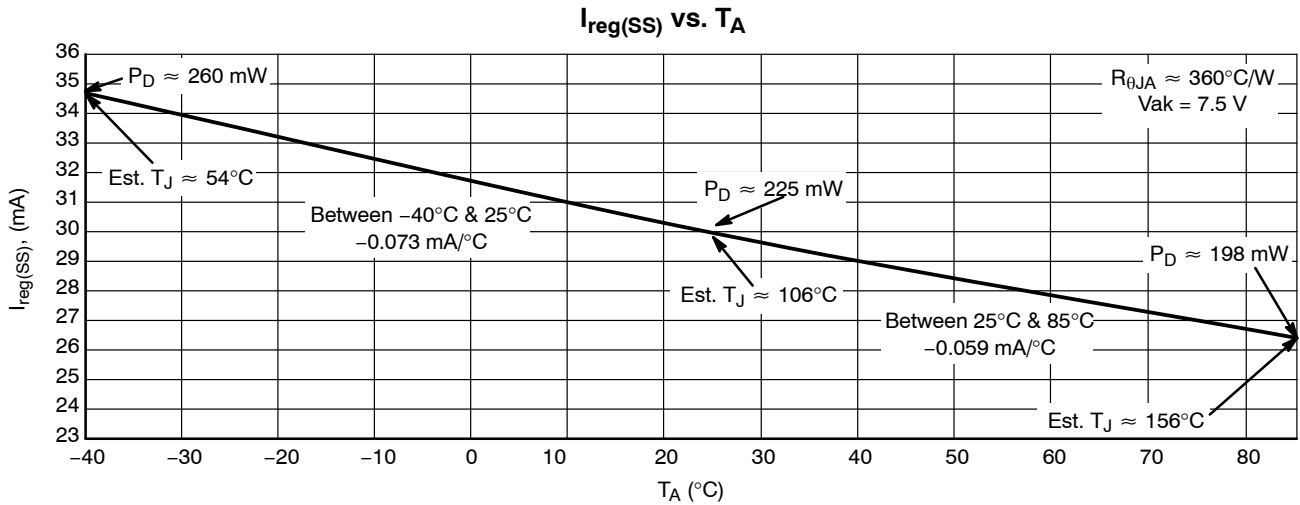

Figure 12. Typical SOD-123 30 mA, 300 mm², 1 oz Cu, In Still Air

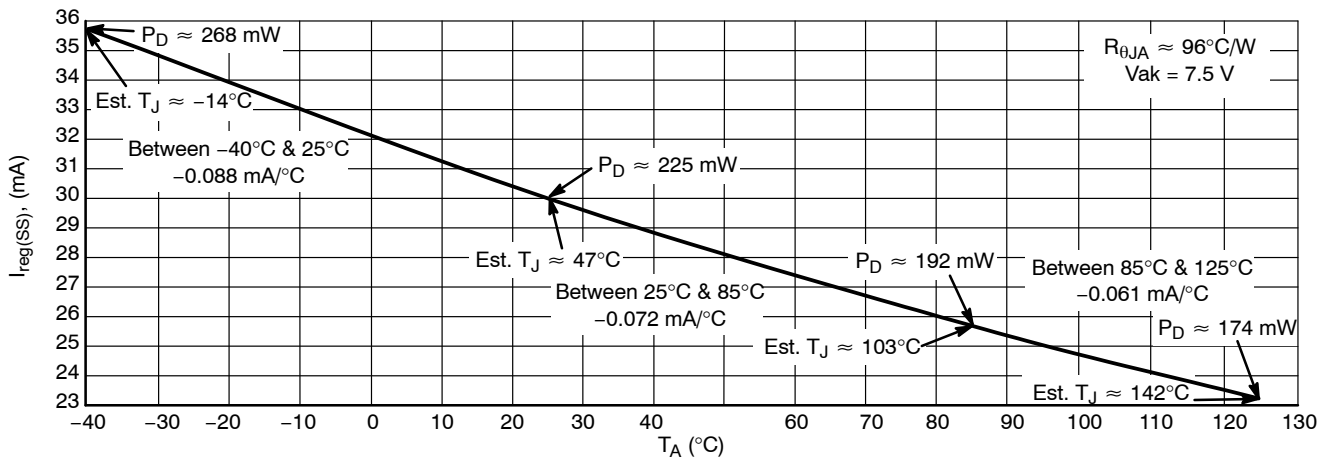

Figure 13. Typical SOT-223 30 mA, 300 mm², 2 oz Cu, In Still Air

PWM Current Control

The power dissipation of the CCR can be reduced when used in a pulse width modulation (pwm) controlled circuit Figure 14. The dc average current will be $I_{reg(SS)} \times$ duty cycle %. For a typical 30 mA CCR at 20% duty cycle, T_A of 25°C, the average current through the LEDs will be 6.0 mA.

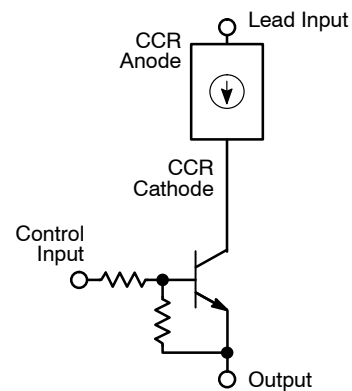

Figure 14.

AND8391/D

The device and heat sink will require analysis for worst case condition to account for 100% duty cycle.

Figures 15 and 16 will assist to determine the temperature rise caused by a power pulse.

Example: If the control input is a 500 Hz, 20% duty cycle pwm applied to the three red LED circuit of Figure 11, the

$R(t)$ for 300 mm² of 1 oz Cu for a SOD-123 from Figure 15 would be $\approx 90^\circ\text{C}/\text{W}$. Therefore; $216 \text{ mW} \times 90^\circ\text{C}/\text{W} = 19.4^\circ\text{C}$ temperature rise.

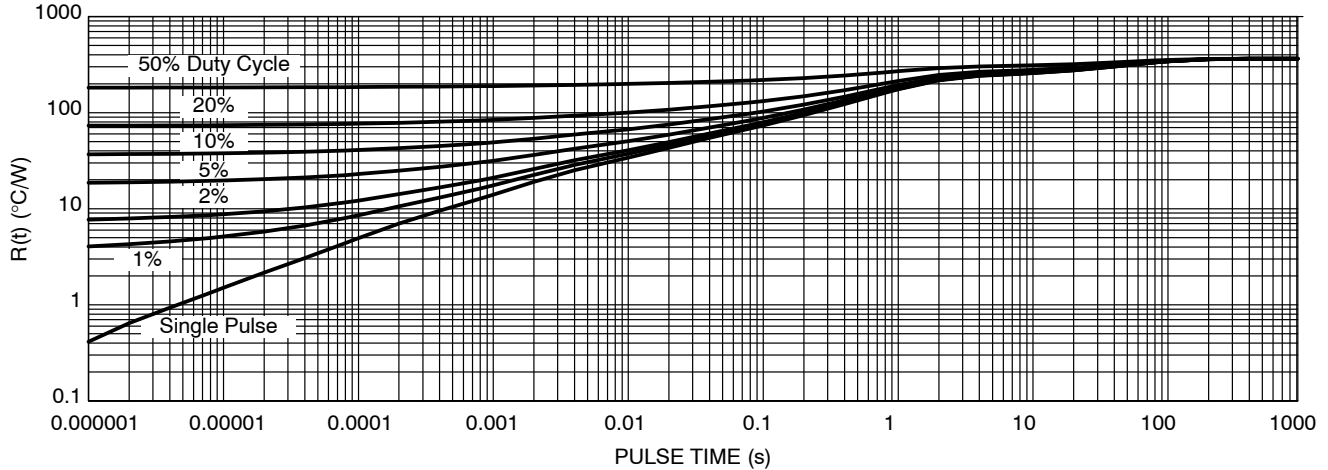

Figure 15. SOD-123 NSI45030T1G PCB Cu Area 300 mm² PCB Cu thk 1.0 oz

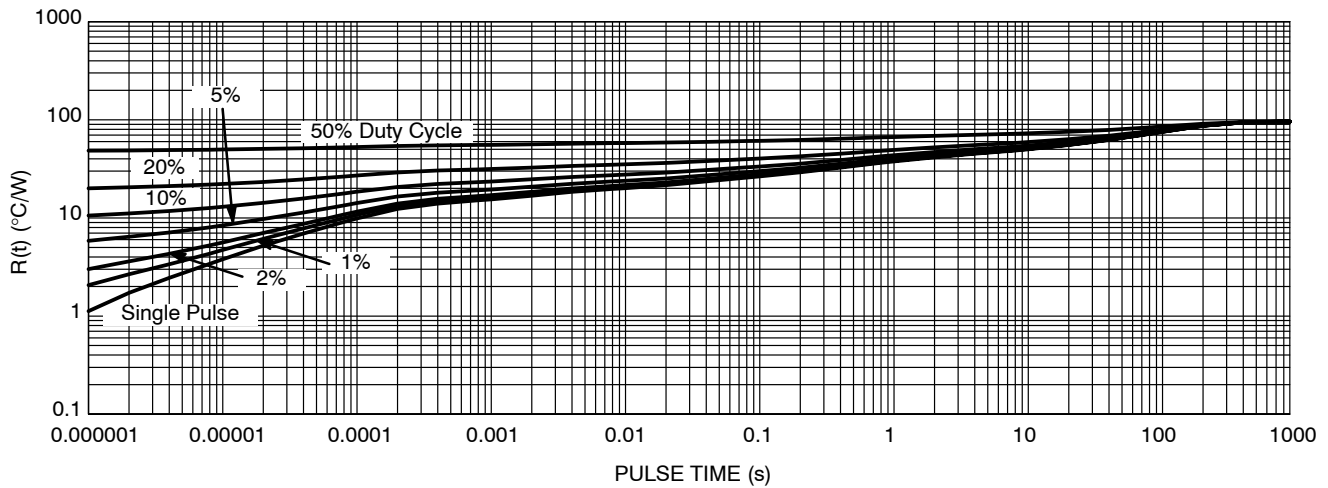

Figure 16. CCR SOT-223 NSI45030ZT1G PCB Cu Area 300 mm² PCB Cu thk 2.0 oz

Summary:

The thermal behavior of a CCR is generalized in the following matrix:

	$T_A \uparrow$	Heatsink Area \uparrow	$V_{ak} \uparrow$
$I_{reg(SS)}$	\downarrow	\uparrow	NC*
T_J	\uparrow	\downarrow	\uparrow

*In general SOD-123 for $3 \text{ V} < V_{ak} < 10 \text{ V}$, all other variables constant: $I_{reg(SS)}$ changes $< 2 \text{ mA}$ (less @ $T_A > 25^\circ\text{C}$).

In general SOT-223 for $3 \text{ V} < V_{ak} < 10 \text{ V}$, all other variables constant: $I_{reg(SS)}$ changes $< 3 \text{ mA}$.

Figure 17.

AND8391/D

APPENDIX A

SOD-123 devices are:

NSI45020T1G, Steady State $I_{reg(SS)} = 20 \text{ mA} \pm 15\%$
NSI45025T1G, Steady State $I_{reg(SS)} = 25 \text{ mA} \pm 15\%$
NSI45030T1G, Steady State $I_{reg(SS)} = 30 \text{ mA} \pm 15\%$
NSI45020AT1G, Steady State $I_{reg(SS)} = 20 \text{ mA} \pm 10\%$
NSI45025AT1G, Steady State $I_{reg(SS)} = 25 \text{ mA} \pm 10\%$
NSI45030AT1G, Steady State $I_{reg(SS)} = 30 \text{ mA} \pm 10\%$

SOT-223 devices are:

NSI45025ZT1G, Steady State $I_{reg(SS)} = 25 \text{ mA} \pm 15\%$
NSI45030ZT1G, Steady State $I_{reg(SS)} = 30 \text{ mA} \pm 15\%$
NSI45025AZT1G, Steady State $I_{reg(SS)} = 25 \text{ mA} \pm 10\%$
NSI45030AZT1G, Steady State $I_{reg(SS)} = 30 \text{ mA} \pm 10\%$

APPENDIX B

Application Note	Title
AND8349/D	Automotive Applications The Use of Discrete Constant Current Regulators (CCR) For CHMSL Lighting
AND8220/D	How To Use Thermal Data Found in Data Sheets
AND8222/D	Predicting the Effect of Circuit Boards on Semiconductor Package Thermal Performance
AND8223/D	Predicting Thermal Runaway

The products described herein (NSI45020T1G, NSI45025T1G, NSI45030T1G, NSI45020AT1G, NSI45025A51G, NSI45030AT1G, NSI45025ZT1G, NSI45030ZT1G, NSI45025AZT1G, NSI45030AZT1G) have patents pending.

ON Semiconductor and  are registered trademarks of Semiconductor Components Industries, LLC (SCILLC). SCILLC reserves the right to make changes without further notice to any products herein. SCILLC makes no warranty, representation or guarantee regarding the suitability of its products for any particular purpose, nor does SCILLC assume any liability arising out of the application or use of any product or circuit, and specifically disclaims any and all liability, including without limitation special, consequential or incidental damages. "Typical" parameters which may be provided in SCILLC data sheets and/or specifications can and do vary in different applications and actual performance may vary over time. All operating parameters, including "Typicals" must be validated for each customer application by customer's technical experts. SCILLC does not convey any license under its patent rights nor the rights of others. SCILLC products are not designed, intended, or authorized for use as components in systems intended for surgical implant into the body, or other applications intended to support or sustain life, or for any other application in which the failure of the SCILLC product could create a situation where personal injury or death may occur. Should Buyer purchase or use SCILLC products for any such unintended or unauthorized application, Buyer shall indemnify and hold SCILLC and its officers, employees, subsidiaries, affiliates, and distributors harmless against all claims, costs, damages, and expenses, and reasonable attorney fees arising out of, directly or indirectly, any claim of personal injury or death associated with such unintended or unauthorized use, even if such claim alleges that SCILLC was negligent regarding the design or manufacture of the part. SCILLC is an Equal Opportunity/Affirmative Action Employer. This literature is subject to all applicable copyright laws and is not for resale in any manner.

PUBLICATION ORDERING INFORMATION

LITERATURE FULFILLMENT:
Literature Distribution Center for ON Semiconductor
P.O. Box 5163, Denver, Colorado 80217 USA
Phone: 303-675-2175 or 800-344-3860 Toll Free USA/Canada
Fax: 303-675-2176 or 800-344-3867 Toll Free USA/Canada
Email: orderlit@onsemi.com

N. American Technical Support: 800-282-9855 Toll Free
USA/Canada
Europe, Middle East and Africa Technical Support:
Phone: 421 33 790 2910
Japan Customer Focus Center
Phone: 81-3-5773-3850

ON Semiconductor Website: www.onsemi.com
Order Literature: <http://www.onsemi.com/orderlit>
For additional information, please contact your local Sales Representative