

NID5003N

Preferred Device

Self-Protected FET with Temperature and Current Limit

42 V, 20 A, Single N-Channel, DPAK

HDPlus™ devices are an advanced series of power MOSFETs which utilize ON Semiconductors latest MOSFET technology process to achieve the lowest possible on-resistance per silicon area while incorporating smart features. Integrated thermal and current limits work together to provide short circuit protection. The devices feature an integrated Drain-to-Gate Clamp that enables them to withstand high energy in the avalanche mode. The Clamp also provides additional safety margin against unexpected voltage transients. Electrostatic Discharge (ESD) protection is provided by an integrated Gate-to-Source Clamp.

Features

- Short Circuit Protection/Current Limit
- Thermal Shutdown with Automatic Restart
- I_{DSS} Specified at Elevated Temperature
- Avalanche Energy Specified
- Slew Rate Control for Low Noise Switching
- Overvoltage Clamped Protection

MOSFET MAXIMUM RATINGS ($T_J = 25^\circ\text{C}$ unless otherwise noted)

| Rating | Symbol | Value | Unit |
|--|---|--------------------|--------------------|
| Drain-to-Source Voltage Internally Clamped | V_{DSS} | 42 | Vdc |
| Gate-to-Source Voltage | V_{GS} | ± 14 | Vdc |
| Drain Current Continuous | I_D | Internally Limited | |
| Total Power Dissipation @ $T_A = 25^\circ\text{C}$ (Note 1) @ $T_A = 25^\circ\text{C}$ (Note 2) | P_D | 1.3 2.3 | W |
| Thermal Resistance Junction-to-Case Junction-to-Ambient (Note 1) Junction-to-Ambient (Note 2) | $R_{\theta JC}$ $R_{\theta JA}$ $R_{\theta JA}$ | 3.0 95 54 | $^\circ\text{C/W}$ |
| Single Pulse Drain-to-Source Avalanche Energy ($V_{DD} = 25\text{ Vdc}$, $V_{GS} = 5.0\text{ Vdc}$, $I_L = 2.6\text{ Apk}$, $L = 120\text{ mH}$, $R_G = 25\ \Omega$) | E_{AS} | 400 | mJ |
| Operating and Storage Temperature Range (Note 3) | T_J , T_{stg} | -55 to 150 | $^\circ\text{C}$ |

Stresses exceeding Maximum Ratings may damage the device. Maximum Ratings are stress ratings only. Functional operation above the Recommended Operating Conditions is not implied. Extended exposure to stresses above the Recommended Operating Conditions may affect device reliability.

1. Surface mounted onto minimum pad size (0.412" square) FR4 PCB, 1 oz cu.
2. Mounted onto 1" square pad size (1.127" square) FR4 PCB, 1 oz cu.
3. Normal pre-fault operating range. See thermal limit range conditions.



ON Semiconductor®

<http://onsemi.com>

| V_{DSS} (Clamped) | $R_{DS(on)}$ TYP | I_D MAX (Limited) |
|---------------------|----------------------|---------------------|
| 42 V | 42 m Ω @ 10 V | 20 A* |

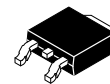
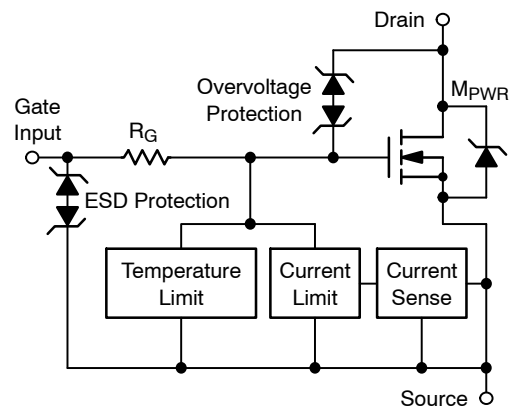

DPAK
CASE 369C
STYLE 2

MARKING DIAGRAM

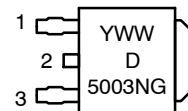

D5003N = Device Code
Y = Year
WW = Work Week
G = Pb-Free Device

1 = Gate
2 = Drain
3 = Source

ORDERING INFORMATION

| Device | Package | Shipping† |
|-------------|----------------|------------------|
| NID5003NT4 | DPAK | 2500/Tape & Reel |
| NID5003NT4G | DPAK (Pb-Free) | 2500/Tape & Reel |

†For information on tape and reel specifications, including part orientation and tape sizes, please refer to our Tape and Reel Packaging Specification Brochure, BRD8011/D.

Preferred devices are recommended choices for future use and best overall value.

*Max current may be limited below this value depending on input conditions.

NID5003N

MOSFET ELECTRICAL CHARACTERISTICS (T_J = 25°C unless otherwise noted)

| Characteristic | Symbol | Min | Typ | Max | Unit |
|----------------|--------|-----|-----|-----|------|
|----------------|--------|-----|-----|-----|------|

OFF CHARACTERISTICS

| | | | | | |
|--|----------------------|----------|------------|----------|------|
| Drain-to-Source Clamped Breakdown Voltage (V _{GS} = 0 Vdc, I _D = 250 μAdc) (V _{GS} = 0 Vdc, I _D = 250 μAdc, T _J = -40°C to 150°C) | V _{(BR)DSS} | 42 40 | 46 45 | 51 51 | Vdc |
| Zero Gate Voltage Drain Current (V _{DS} = 32 Vdc, V _{GS} = 0 Vdc) (V _{DS} = 32 Vdc, V _{GS} = 0 Vdc, T _J = 150°C) | I _{DSS} | - - | 0.6 2.5 | 5.0 - | μAdc |
| Gate Input Current (V _{GS} = 5.0 Vdc, V _{DS} = 0 Vdc) | I _{GSSF} | - | 50 | 125 | μAdc |

ON CHARACTERISTICS

| | | | | | |
|--|---------------------|----------|------------|-----------|---------------|
| Gate Threshold Voltage (V _{DS} = V _{GS} , I _D = 1.2 mAdc) Threshold Temperature Coefficient | V _{GS(th)} | 1.0 - | 1.7 5.0 | 2.2 - | Vdc -mV/°C |
| Static Drain-to-Source On-Resistance (Note 4) (V _{GS} = 10 Vdc, I _D = 3.0 Adc, T _J @ 25°C) (V _{GS} = 10 Vdc, I _D = 3.0 Adc, T _J @ 150°C) | R _{DS(on)} | - - | 42 76 | 51 104 | mΩ |
| Static Drain-to-Source On-Resistance (Note 4) (V _{GS} = 5.0 Vdc, I _D = 3.0 Adc, T _J @ 25°C) (V _{GS} = 5.0 Vdc, I _D = 3.0 Adc, T _J @ 150°C) | R _{DS(on)} | - - | 50 88 | 58 125 | mΩ |
| Source-Drain Forward On Voltage (I _S = 7.0 A, V _{GS} = 0 V) | V _{SD} | - | 0.95 | 1.1 | V |

SWITCHING CHARACTERISTICS

| | | | | | | |
|---|---|-------------------------------------|---|-----|-----|------|
| Turn-on Time (V _{in} to 90% I _D) | R _L = 4.7 Ω, V _{in} = 0 to 10 V, V _{DD} = 12 V | T _(on) | - | 16 | 20 | μs |
| Turn-off Time (V _{in} to 10% I _D) | R _L = 4.7 Ω, V _{in} = 0 to 10 V, V _{DD} = 12 V | T _(off) | - | 80 | 100 | μs |
| Slew Rate On | R _L = 4.7 Ω, V _{in} = 0 to 10 V, V _{DD} = 12 V | -dV _{DS} /dt _{on} | - | 1.4 | - | V/μs |
| Slew Rate Off | R _L = 4.7 Ω, V _{in} = 10 to 0 V, V _{DD} = 12 V | dV _{DS} /dt _{off} | - | 0.5 | - | V/μs |

SELF PROTECTION CHARACTERISTICS (T_J = 25°C unless otherwise noted) (Note 5)

| | | | | | | |
|------------------------------|---|-----------------------|----------|----------|----------|-----|
| Current Limit | (V _{GS} = 5.0 Vdc) V _{DS} = 10 V (V _{GS} = 5.0 Vdc, T _J = 150°C) | I _{LIM} | 12 7 | 18 13 | 24 18 | Adc |
| Current Limit | (V _{GS} = 10 Vdc) V _{DS} = 10 V (V _{GS} = 10 Vdc, T _J = 150°C) | I _{LIM} | 18 13 | 22 18 | 30 25 | Adc |
| Temperature Limit (Turn-off) | V _{GS} = 5.0 Vdc | T _{LIM(off)} | 150 | 175 | 200 | °C |
| Thermal Hysteresis | V _{GS} = 5.0 Vdc | ΔT _{LIM(on)} | - | 15 | - | °C |
| Temperature Limit (Turn-off) | V _{GS} = 10 Vdc | T _{LIM(off)} | 150 | 165 | 185 | °C |
| Thermal Hysteresis | V _{GS} = 10 Vdc | ΔT _{LIM(on)} | - | 15 | - | °C |

ESD ELECTRICAL CHARACTERISTICS (T_J = 25°C unless otherwise noted)

| | | | | | |
|---|-----|-------------|--------|--------|---|
| Electro-Static Discharge Capability Human Body Model (HBM) Machine Model (MM) | ESD | 4000 400 | - - | - - | V |
|---|-----|-------------|--------|--------|---|

4. Pulse Test: Pulse Width ≤ 300 μs, Duty Cycle ≤ 2%.
5. Fault conditions are viewed as beyond the normal operating range of the part.

TYPICAL PERFORMANCE CURVES

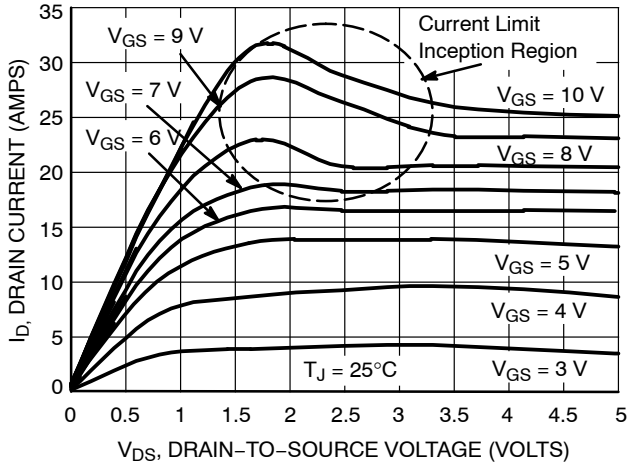

Figure 1. On-Region Characteristics

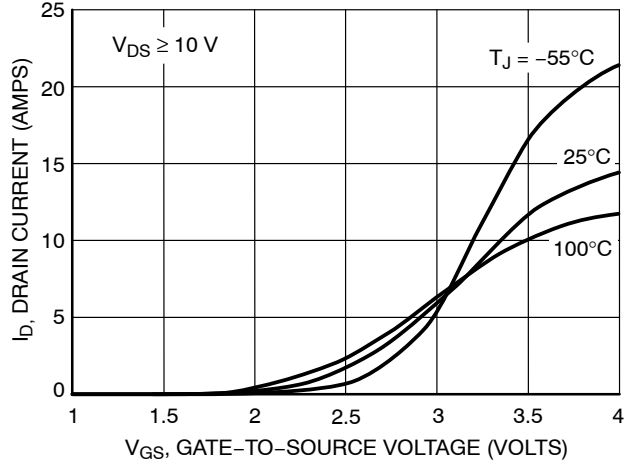

Figure 2. Transfer Characteristics

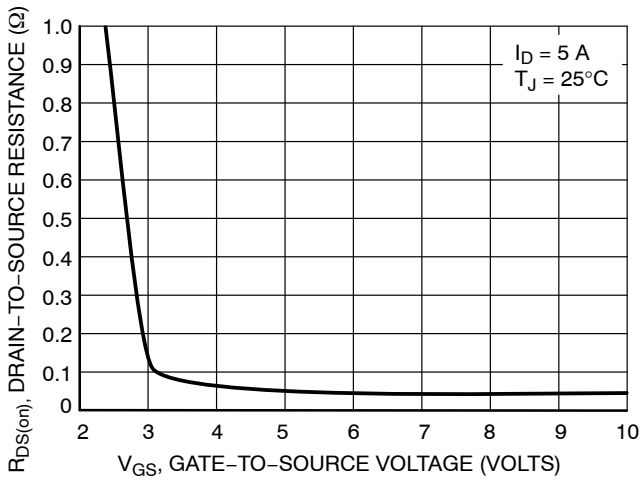

Figure 3. On-Resistance vs. Gate-to-Source Voltage

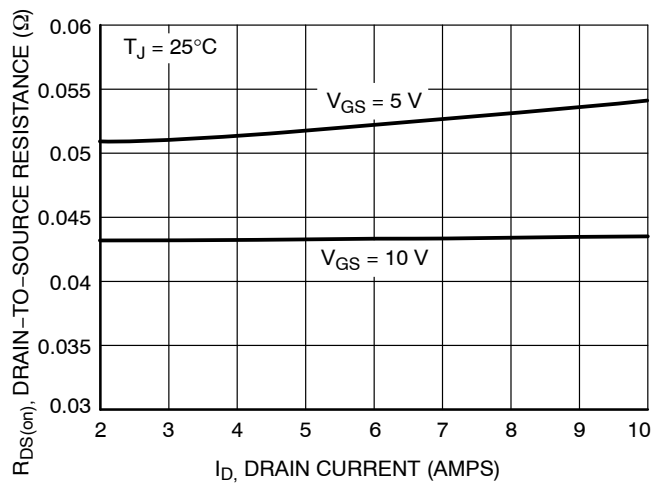

Figure 4. On-Resistance vs. Drain Current and Gate Voltage

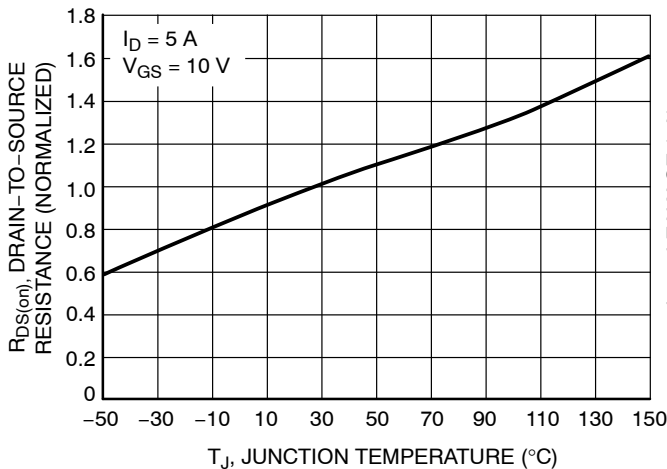

Figure 5. On-Resistance Variation with Temperature

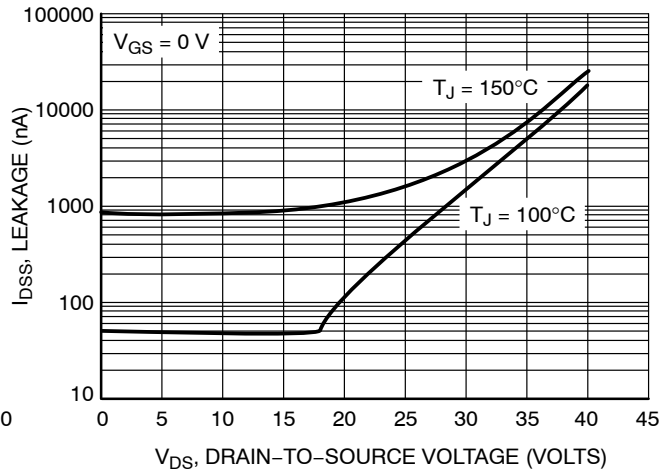

Figure 6. Drain-to-Source Leakage Current vs. Voltage

NID5003N

TYPICAL PERFORMANCE CURVES

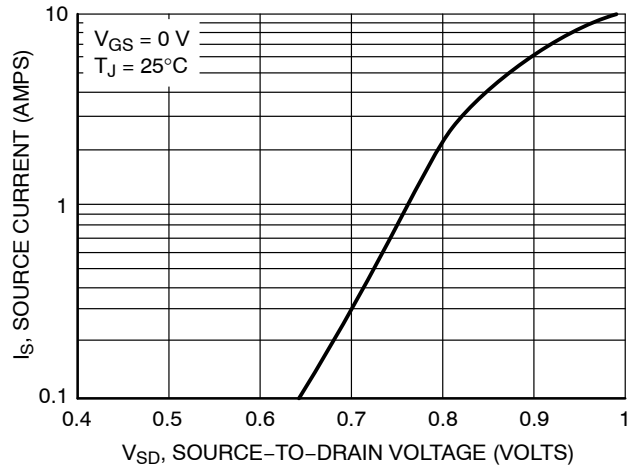
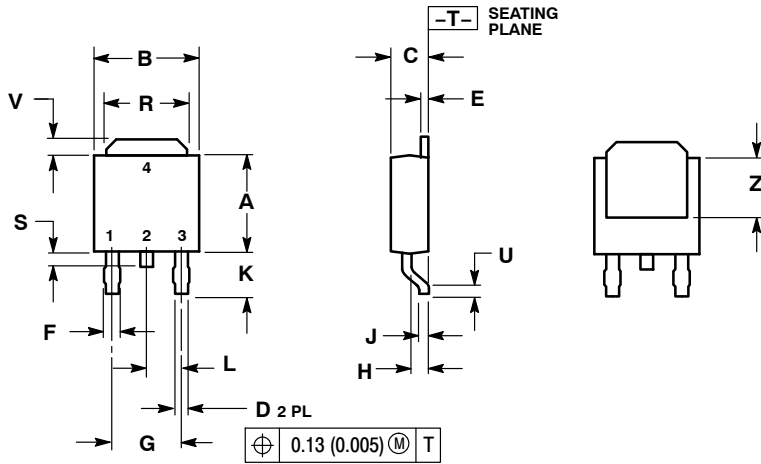

Figure 7. Diode Forward Voltage vs. Current

NID5003N

PACKAGE DIMENSIONS

DPAK
CASE 369C-01
ISSUE O



- NOTES:
 1. DIMENSIONING AND TOLERANCING PER ANSI Y14.5M, 1982.
 2. CONTROLLING DIMENSION: INCH.

| DIM | INCHES | | MILLIMETERS | |
|-----|-----------|-------|-------------|------|
| | MIN | MAX | MIN | MAX |
| A | 0.235 | 0.245 | 5.97 | 6.22 |
| B | 0.250 | 0.265 | 6.35 | 6.73 |
| C | 0.086 | 0.094 | 2.19 | 2.38 |
| D | 0.027 | 0.035 | 0.69 | 0.88 |
| E | 0.018 | 0.023 | 0.46 | 0.58 |
| F | 0.037 | 0.045 | 0.94 | 1.14 |
| G | 0.180 BSC | | 4.58 BSC | |
| H | 0.034 | 0.040 | 0.87 | 1.01 |
| J | 0.018 | 0.023 | 0.46 | 0.58 |
| K | 0.102 | 0.114 | 2.60 | 2.89 |
| L | 0.090 BSC | | 2.29 BSC | |
| R | 0.180 | 0.215 | 4.57 | 5.45 |
| S | 0.025 | 0.040 | 0.63 | 1.01 |
| U | 0.020 | --- | 0.51 | --- |
| V | 0.035 | 0.050 | 0.89 | 1.27 |
| Z | 0.155 | --- | 3.93 | --- |

- STYLE 2:
 PIN 1. GATE
 2. DRAIN
 3. SOURCE
 4. DRAIN

SOLDERING FOOTPRINT

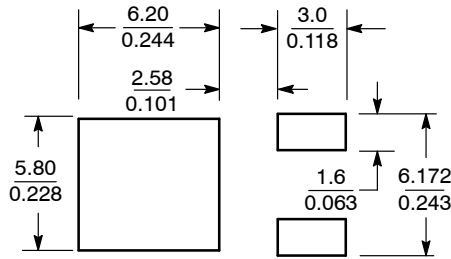

SCALE 3:1 $\left(\frac{\text{mm}}{\text{inches}} \right)$

HDPlus is a trademark of Semiconductor Components Industries, LLC (SCILLC)

ON Semiconductor and are registered trademarks of Semiconductor Components Industries, LLC (SCILLC). SCILLC reserves the right to make changes without further notice to any products herein. SCILLC makes no warranty, representation or guarantee regarding the suitability of its products for any particular purpose, nor does SCILLC assume any liability arising out of the application or use of any product or circuit, and specifically disclaims any and all liability, including without limitation special, consequential or incidental damages. "Typical" parameters which may be provided in SCILLC data sheets and/or specifications can and do vary in different applications and actual performance may vary over time. All operating parameters, including "Typicals" must be validated for each customer application by customer's technical experts. SCILLC does not convey any license under its patent rights nor the rights of others. SCILLC products are not designed, intended, or authorized for use as components in systems intended for surgical implant into the body, or other applications intended to support or sustain life, or for any other application in which the failure of the SCILLC product could create a situation where personal injury or death may occur. Should Buyer purchase or use SCILLC products for any such unintended or unauthorized application, Buyer shall indemnify and hold SCILLC and its officers, employees, subsidiaries, affiliates, and distributors harmless against all claims, costs, damages, and expenses, and reasonable attorney fees arising out of, directly or indirectly, any claim of personal injury or death associated with such unintended or unauthorized use, even if such claim alleges that SCILLC was negligent regarding the design or manufacture of the part. SCILLC is an Equal Opportunity/Affirmative Action Employer. This literature is subject to all applicable copyright laws and is not for resale in any manner.

PUBLICATION ORDERING INFORMATION

LITERATURE FULFILLMENT:
 Literature Distribution Center for ON Semiconductor
 P.O. Box 5163, Denver, Colorado 80217 USA
Phone: 303-675-2175 or 800-344-3860 Toll Free USA/Canada
Fax: 303-675-2176 or 800-344-3867 Toll Free USA/Canada
Email: orderlit@onsemi.com

N. American Technical Support: 800-282-9855 Toll Free USA/Canada
Europe, Middle East and Africa Technical Support:
 Phone: 421 33 790 2910
Japan Customer Focus Center
 Phone: 81-3-5773-3850

ON Semiconductor Website: www.onsemi.com

Order Literature: <http://www.onsemi.com/orderlit>

For additional information, please contact your local Sales Representative