

TAPE PACKING OPTIONS

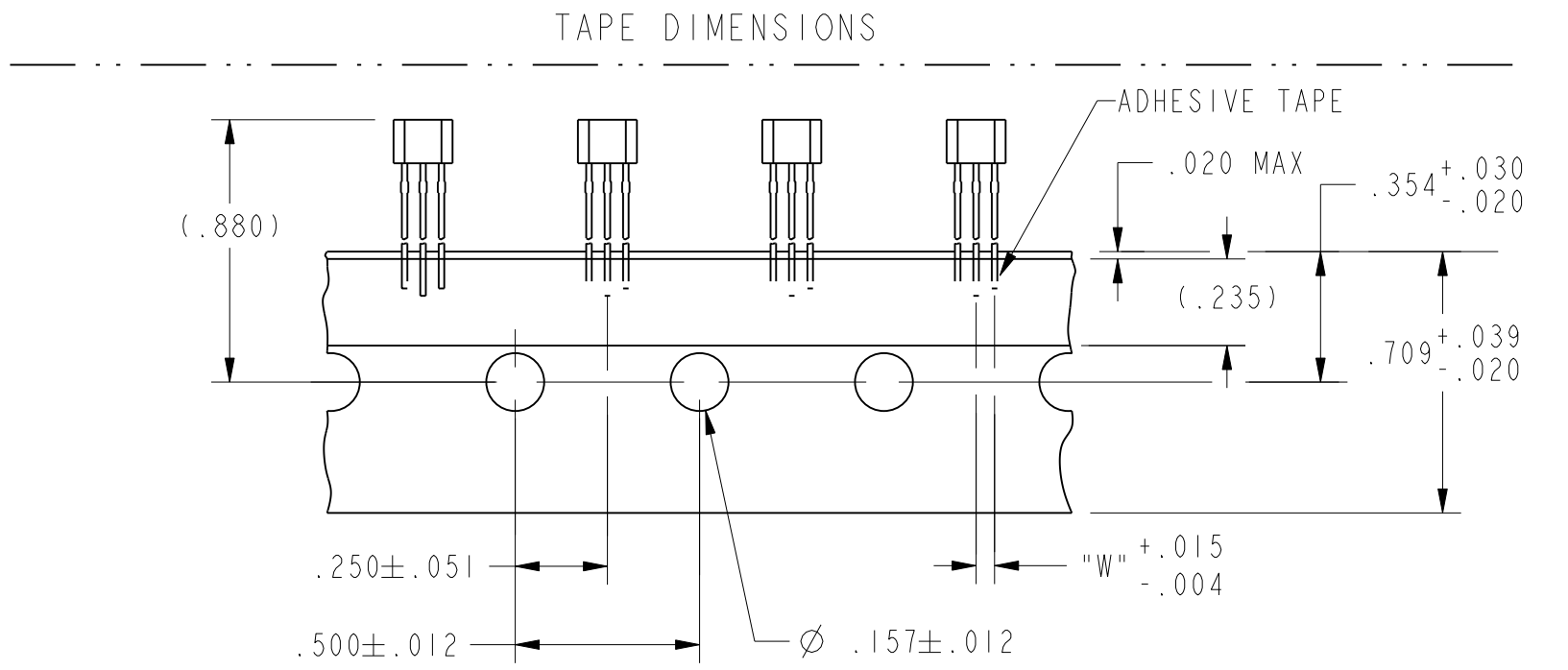

TAPE STYLE

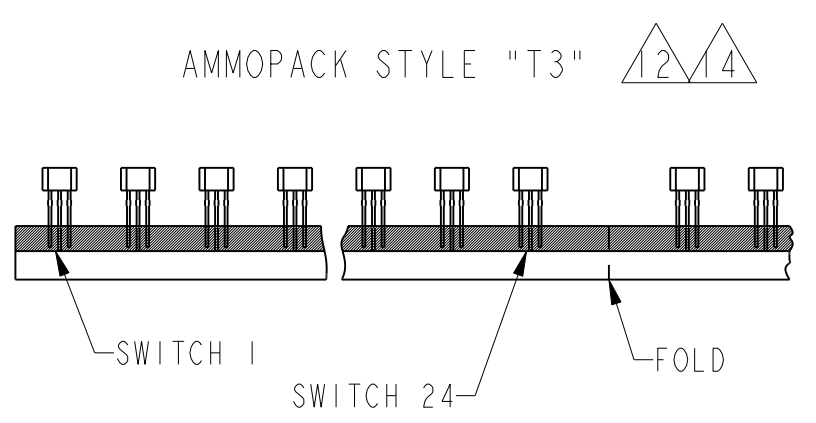
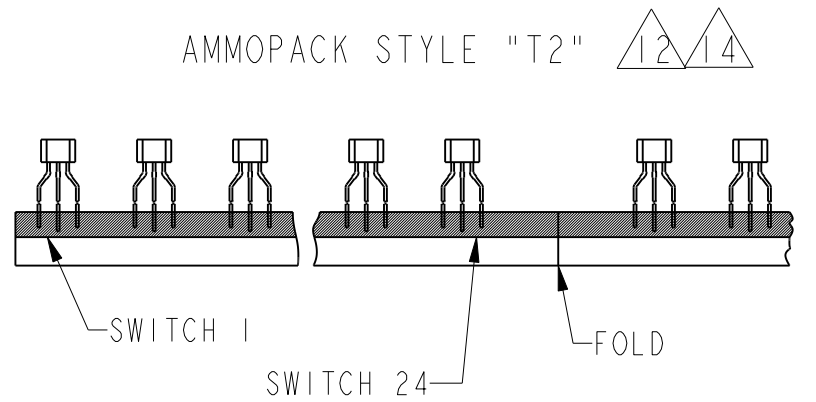

- NOTES
- 1 CENTERLINE OF HALL CELL
 - 2 THE + MAGNETIC FLUX IS IN THE DIRECTION SHOWN (THIS ASSUMES THE CONVENTION THAT THE DIRECTION OF THE EXTERNAL FLUX OF A MAGNET IS FROM THE NORTH TO THE SOUTH POLE OF THE MAGNET)
 - 3 - THE DEVICE CANNOT BE DAMAGED BY MAGNETIC OVERDRIVE
 - 4 - OUTPUT TYPE - RATIOMETRIC
 - 5 - LEADS MUST BE ADEQUATELY SUPPORTED DURING ANY FORMING/SHEERING OPERATION TO ASSURE THAT THE LEADS ARE NOT STRESSED WITHIN THE PLASTIC
 - 6 - PCB WAVE SOLDERING GUIDELINES ARE AS FOLLOWS:
250°C PEAK FOR 10 S MAX OR 260°C PEAK FOR 5 S MAX.
 - 7 BURRS ARE ALLOWED ONLY IF FULL LENGTH OF LEADS WILL PASS THROUGH ∅ .023 HOLE.
 - 8 LEAD REFERENCE DIMENSIONS DO NOT INCLUDE SOLDER THICKNESS
 - 9 DIMENSION REFERS TO THE LOCATION OF LEAD CENTERLINES AS THE EXIT THE PLASTIC PACKAGE
 - 10 - SOME COMBINATIONS OF BASIC LISTING AND PACKAGE OPTIONS MAY NOT BE AVAILABLE
 - 11 ABSOLUTE MAXIMUM RATINGS ARE THE EXTREME LIMITS THE DEVICE WILL MOMENTARILY WITHSTAND WITHOUT DAMAGE TO THE DEVICE. ELECTRICAL AND MAGNETIC CHARACTERISTICS ARE NOT GUARANTEED IF THE RATED VOLTAGE AND/OR CURRENTS ARE EXCEEDED NOR WILL THE DEVICE NECESSARILY OPERATE AT ABSOLUTE MAXIMUM RATINGS
 - 12 LEAD STRAIGHTNESS MAY BE DETERIORATED ON SOME UNITS BY BULK PACKAGING. APPLICATIONS HAVING A CRITICAL LEAD STRAIGHTNESS REQUIREMENT SHOULD USE A TAPE PACKAGING OPTION
 - 13 AMMOPACK STYLE "T2" & "T3": 24 SWITCHES BETWEEN FOLDS, SKIP 1 SPACE AT FOLD. MAY BE REFERRED TO AS "FAN FOLD"
 - 14 MOLDED PART DIMENSIONS DO NOT INCLUDE FLASH. FLASH IS LIMITED TO .005 MAX
 - 15 TAPE AND AMMOPACK PER EIA-468
 - 16 POCKET TAPE PER EIA-481

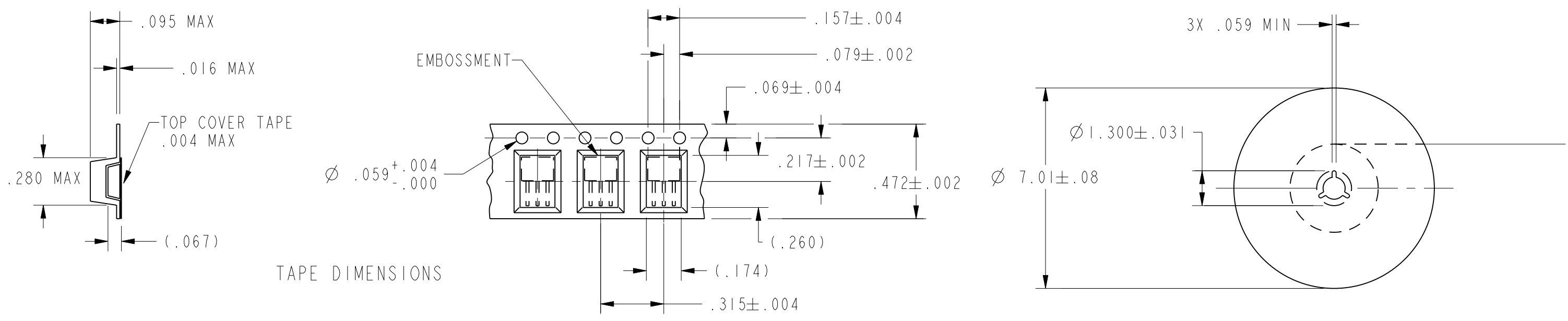

TAPE DIMENSIONS

TAPE STYLE "P"

| CATALOG LISTING | TAPE STYLE | DIM "L" | DIM "W" | COMMENTS |
|-----------------|------------|---------|---------|---------------------------|
| SS495A | NONE | .590 | .050 | BULK - 1000/BAG |
| SS495A-T2 | T2 | .590 | .100 | 5000/BOX |
| SS495A-T3 | T3 | .590 | .050 | 5000/BOX |
| SS495A-S | NONE | .125 | .050 | BULK - 1000/BAG |
| SS495A-SP | P | .125 | .050 | 1000/PACKET TAPE AND REEL |
| SS495A1 | NONE | .590 | .050 | BULK - 1000/BAG |
| SS495A1-T2 | T2 | .590 | .100 | 5000/BOX |
| SS495A1-T3 | T3 | .590 | .050 | 5000/BOX |
| SS495A1-S | NONE | .125 | .050 | BULK - 1000/BAG |
| SS495A1-SP | P | .125 | .050 | 1000/PACKET TAPE AND REEL |
| SS495A2 | NONE | .590 | .050 | BULK - 1000/BAG |
| SS495A2-S | NONE | .125 | .050 | BULK - 1000/BAG |
| SS495A2-SP | P | .125 | .050 | 1000/PACKET TAPE AND REEL |
| SS495A2-T2 | T2 | .590 | .100 | 5000/BOX |
| SS495A2-T3 | T3 | .590 | .050 | 5000/BOX |
| SS495A-L | NONE | .735 | .050 | BULK - 1000/BAG |
| SS495A1-L | NONE | .735 | .050 | BULK - 1000/BAG |
| SS495A2-L | NONE | .735 | .050 | BULK - 1000/BAG |
| SS495B | NONE | .590 | .050 | BULK - 1000/BAG |
| SS495B-T2 | T2 | .590 | .100 | 5000/BOX |
| SS495B-T3 | T3 | .590 | .050 | 5000/BOX |
| SS495B-S | NONE | .125 | .050 | BULK - 1000/BAG |
| SS495B-SP | P | .125 | .050 | 1000/PACKET TAPE AND REEL |

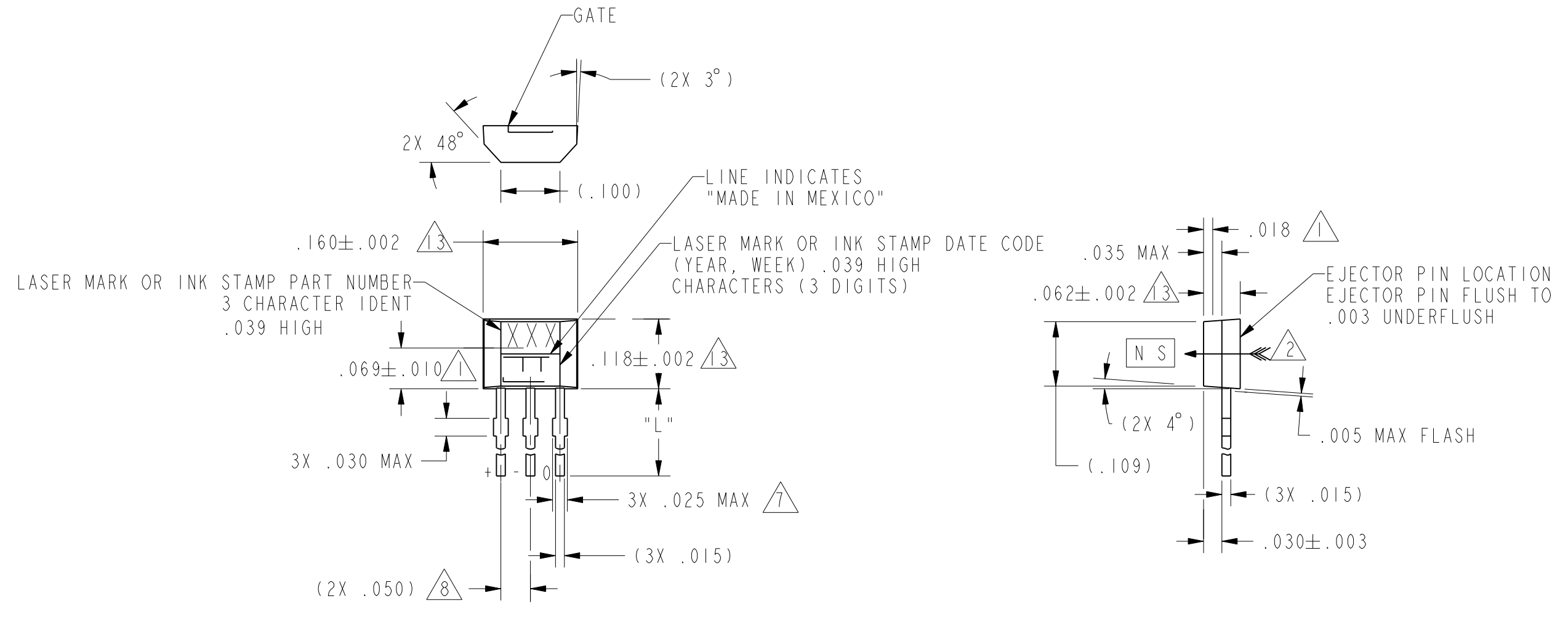

OPTIONAL SURFACE MOUNT LEAD STYLE

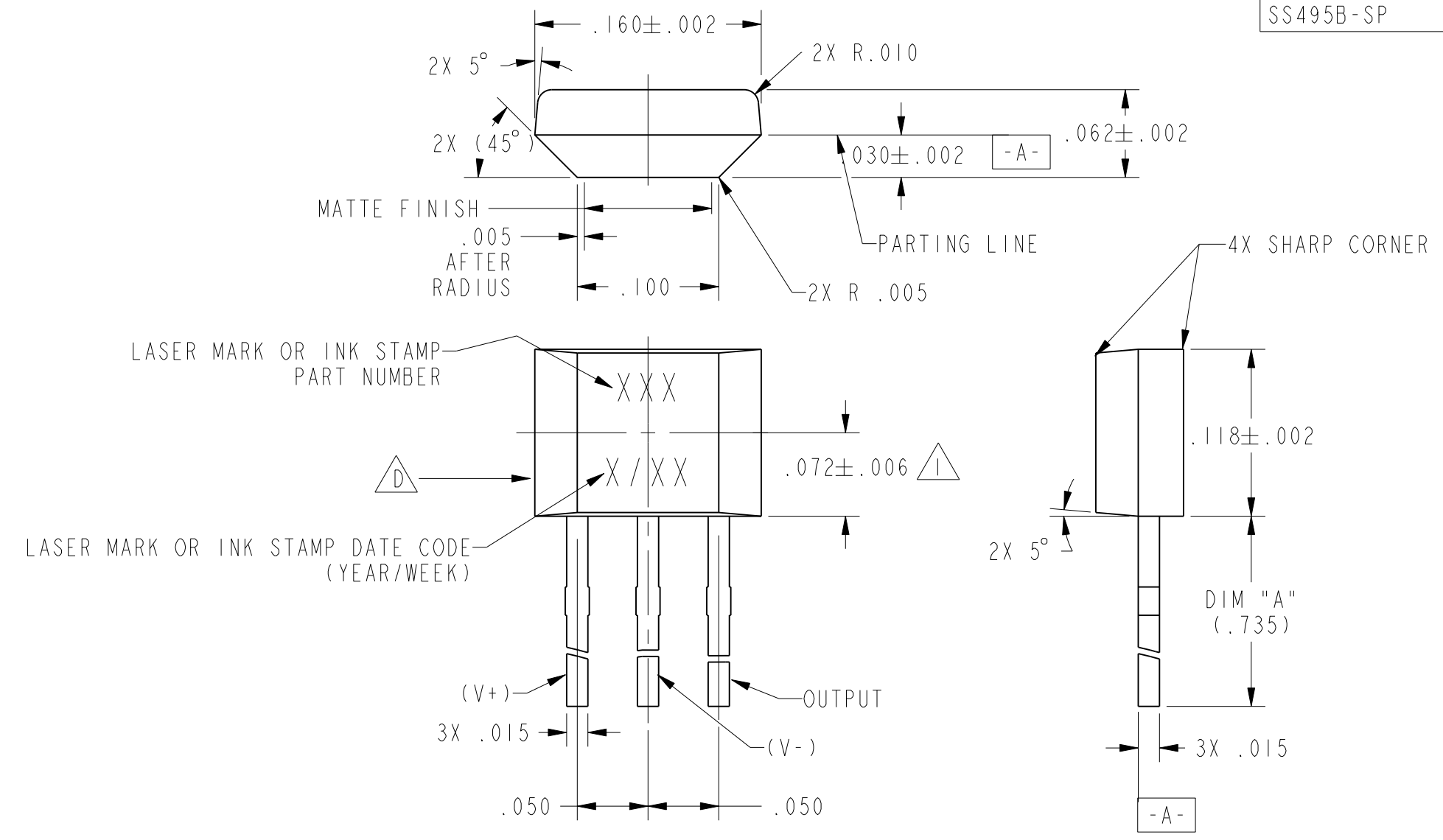

LEAD STYLES L ONLY
SCALE 10:1

PTC/CAD 2D
 DRAWN
 C.S.L. 14 APR 02
 CHECK
 SAV 4 APR 02
 RELEASE NO. PR-21283
 OF 5
 SS495 SERIES CHART 1
 ISSUE
 14
 REVISIONS
 1
 083535
 26 OCT 01
 CHECK
 14



THIS DRAWING COVERS A PROPRIETARY ITEM AND IS THE PROPERTY OF MICRO SWITCH, A DIVISION OF HONEYWELL. THIS DRAWING IS NOT TO BE COPIED OR USED WITHOUT THE APPROVAL OF MICRO SWITCH.
 FED. MFG. CODE 91929
MICRO SWITCH
 a Honeywell Division
MINIATURE RATIOMETRIC LINEAR HALL EFFECT SENSOR
SS495 SERIES CHART 1

THIRD ANGLE PROJECTION

SCALE 5:1

DO NOT SCALE PRINT

UNLESS OTHERWISE SPECIFIED TOLERANCES ARE

| | | |
|-------------|--------|--------|
| ONE PLACE | (.0) | + .030 |
| TWO PLACE | (.00) | + .015 |
| THREE PLACE | (.000) | + .005 |
| ANGLES | | + 2° |

WEIGHT

CHARACTERISTICS ARE AT $V_s=5.0$ WITH 4.7K OUTPUT TO MINUS WITH $T_A=-40^{\circ}\text{C}$ TO $+125^{\circ}\text{C}$ UNLESS OTHERWISE SPECIFIED

SS495A

SS495 SERIES CHART 1

| PARAMETER | CONDITIONS | MIN | TYP | MAX | UNITS |
|-------------------------------|--|------------|------------|-------|-----------|
| SENSITIVITY | $T_A = 25^{\circ}\text{C}$ | 3.00 | 3.125 | 3.25 | mV/GAUSS |
| NULL | $T_A = 25^{\circ}\text{C}$ | 2.425 | 2.50 | 2.575 | VOLTS |
| SUPPLY CURRENT | $T_A = 25^{\circ}\text{C}$ | | 7 | 8.7 | mA |
| OUTPUT CURRENT | SOURCE $V_s > 4.5$ | 1mA | 1.5mA | | |
| | SINK $V_s > 4.5$ | .6mA | 1.5mA | | |
| | SINK $V_s > 5.0$ | 1mA | 1.5mA | | |
| RESPONSE TIME | | | 3μS | | |
| OUTPUT VOLTAGE SWING | VOM - | .4 | .2 | | VOLTS |
| | VOM + | $V_s - .4$ | $V_s - .2$ | | VOLTS |
| B LIMITS FOR LINEAR OPERATION | -B MAX | -600 | -670 | | GAUSS |
| | +B MAX | +600 | +670 | | GAUSS |
| V_{null} DRIFT | $B = 0, T_A = 25^{\circ}\text{C TO } 125^{\circ}\text{C}$ | -.06 | | +.06 | % / °C |
| V_{null} DRIFT | $B = 0, T_A = -125^{\circ}\text{C TO } +150^{\circ}\text{C}$ | -.08 | | +.08 | % / °C |
| SENSITIVITY DRIFT | $T_A = +25^{\circ}\text{C TO } +150^{\circ}\text{C}$ | -.01 | | +.05 | % / °C |
| SENSITIVITY DRIFT | $T_A = -40^{\circ}\text{C TO } +25^{\circ}\text{C}$ | 0 | | +.06 | % / °C |
| LINEARITY | $B = -600 \text{ TO } +600$ | 0 | -1.0 | -1.5 | % OF SPAN |
| SUPPLY VOLTAGE | $-40^{\circ}\text{C TO } +125^{\circ}\text{C}$ | 4.5 | 5.0 | 10.5 | VOLTS |
| OPERATING TEMP | SEE MAX TEMPERATURE CHART | -40 | | +150 | °C |

BLOCK DIAGRAM CURRENT SINKING OR SOURCING OUTPUT

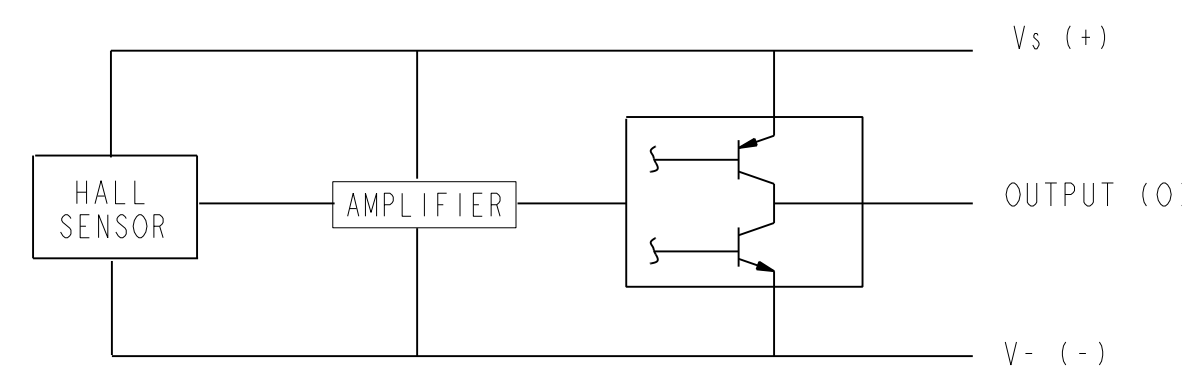

ABSOLUTE MAXIMUM CHARACTERISTICS

| CHARACTERISTIC | SYMBOL | TEST CONDITION | MIN | MAX | UNITS |
|----------------|-----------|------------------------|------|-----|-------|
| SUPPLY VOLTAGE | V_{cc} | | -0.5 | 11 | V |
| OUTPUT VOLTAGE | V_{out} | | -0.5 | 11 | V |
| OUTPUT CURRENT | I_{out} | SOURCE OR SINK | | 10 | mA |
| TEMPERATURE | T_A | OPERATING | -55 | 150 | °C |
| | T_s | STORAGE ($V_{cc}=0$) | -55 | 165 | °C |

NULL SHIFT VERSUS TEMPERATURE

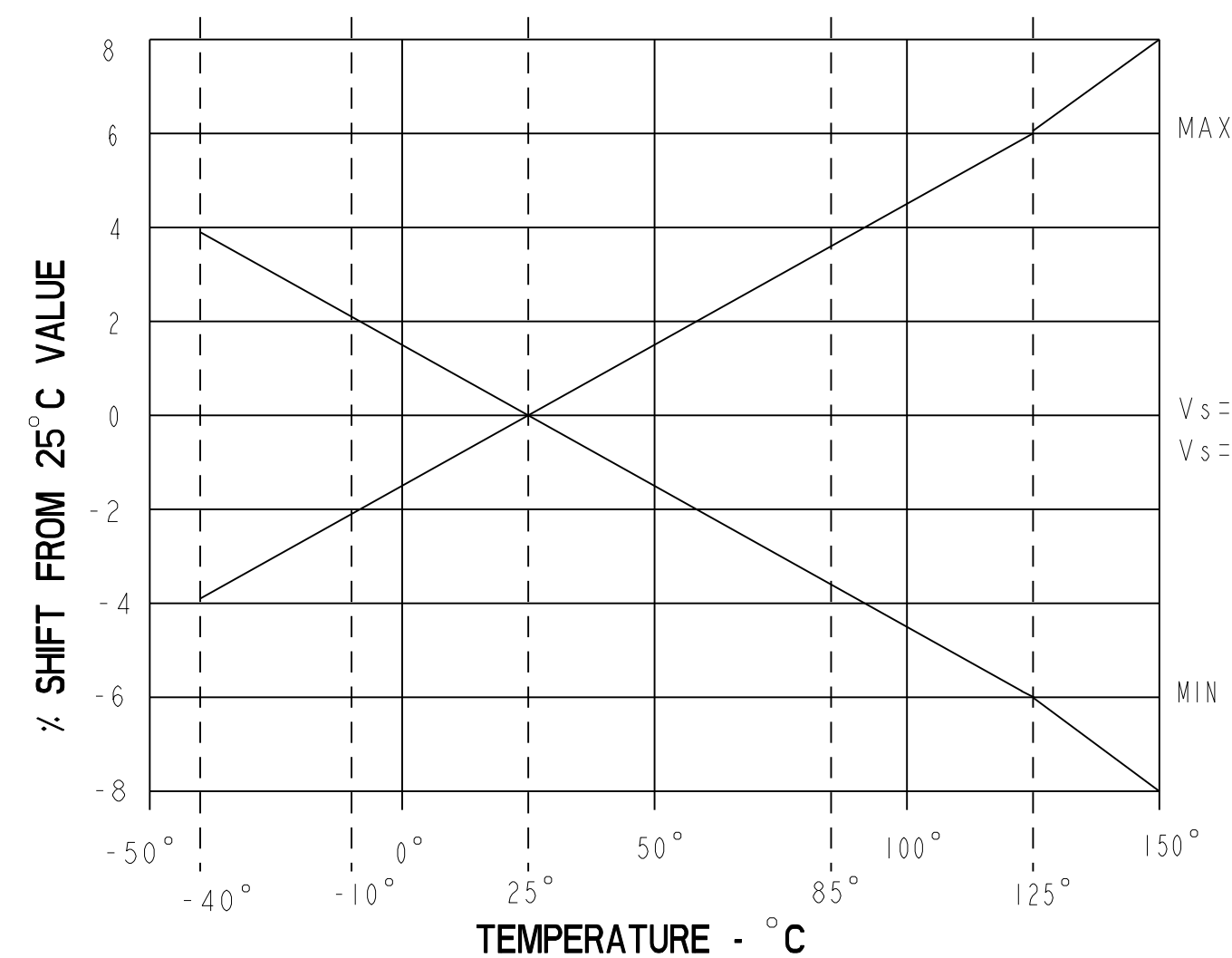

RATIO OF V_{null} TO V_s

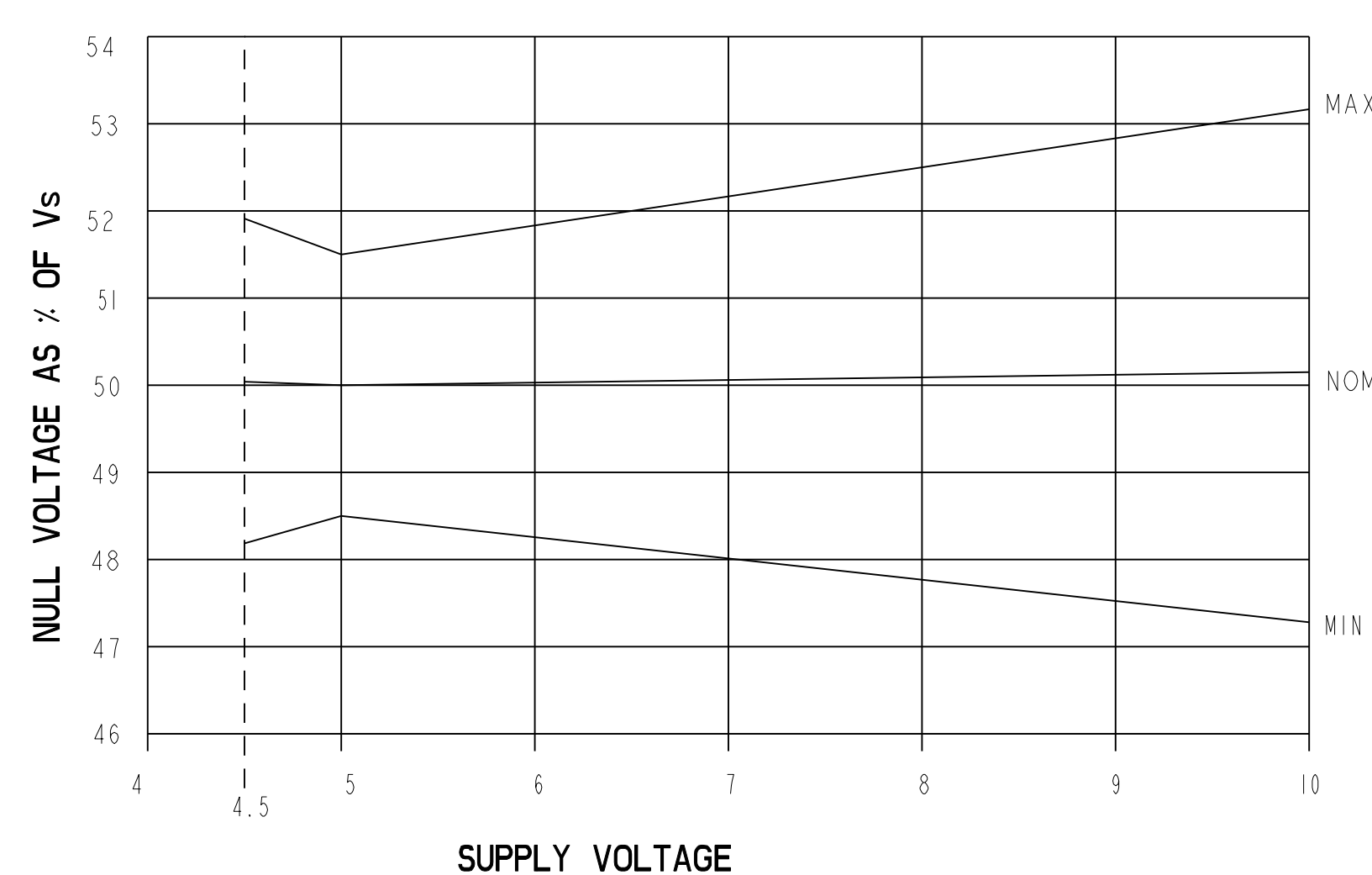

SENSITIVITY SHIFT VERSUS TEMPERATURE

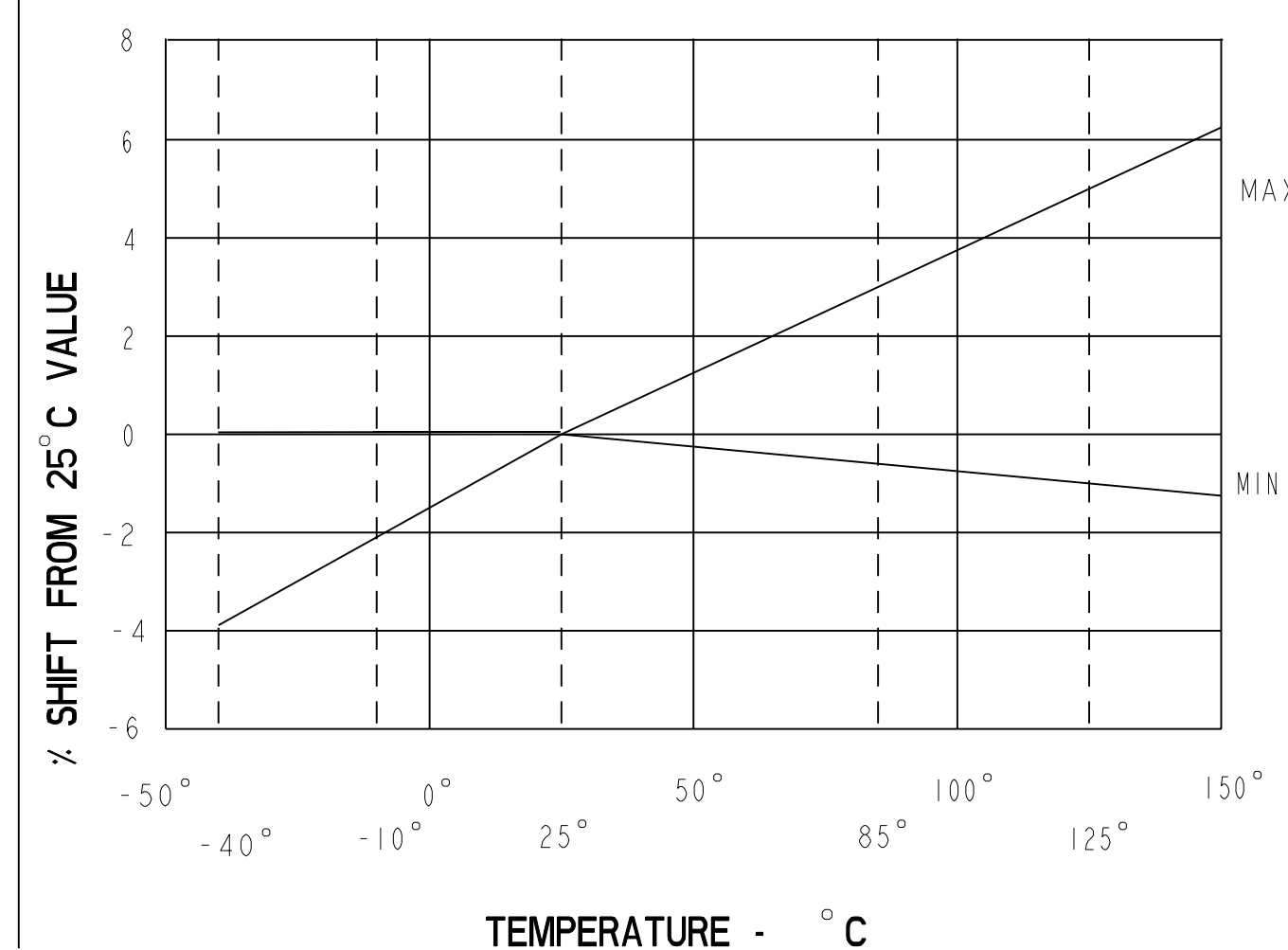

SENSITIVITY/V VERSUS V_s
(mV/GAUSS/VOLT)

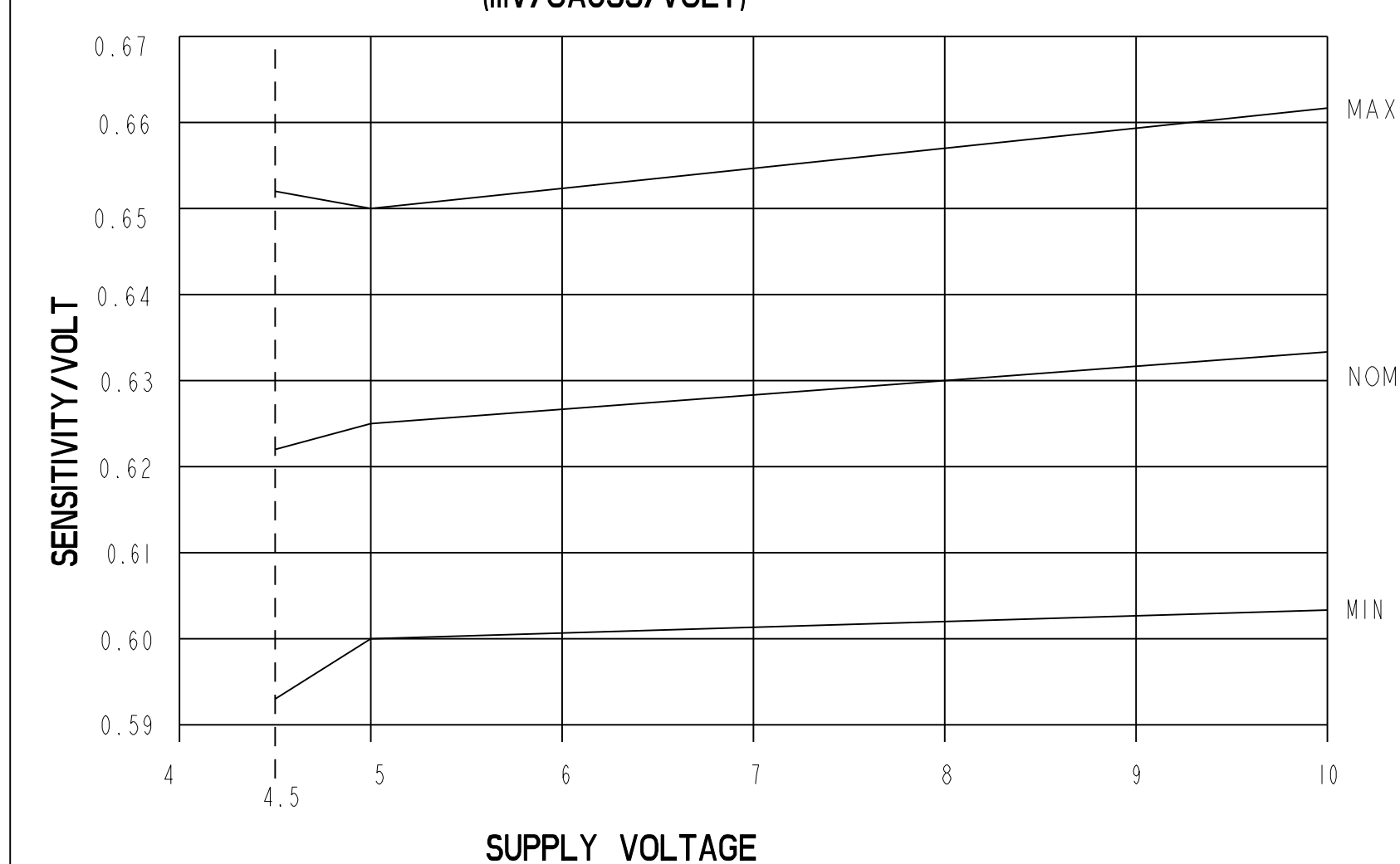

LINEARITY VERSUS V_s
END POINT OF SPAN METHOD

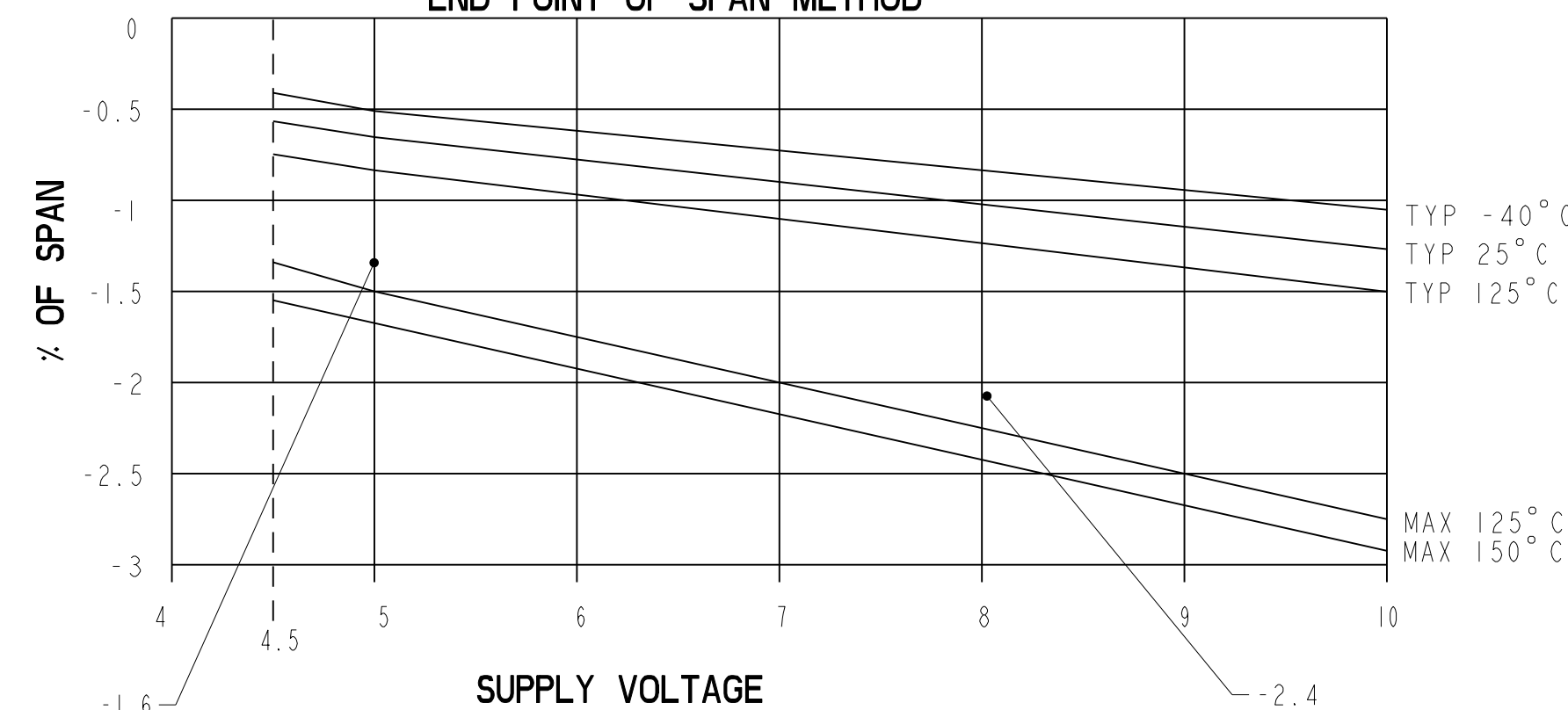

TRANSFER CHARACTERISTICS AT $V_s=5.0$ VDC

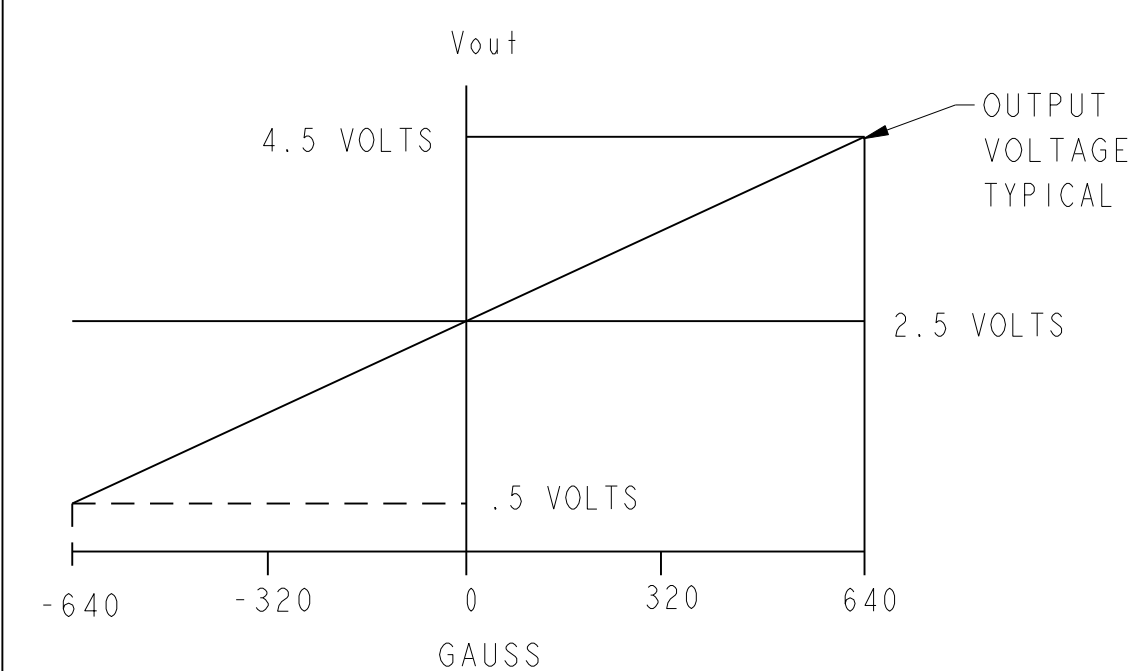

SUPPLY CURRENT VERSUS TEMPERATURE

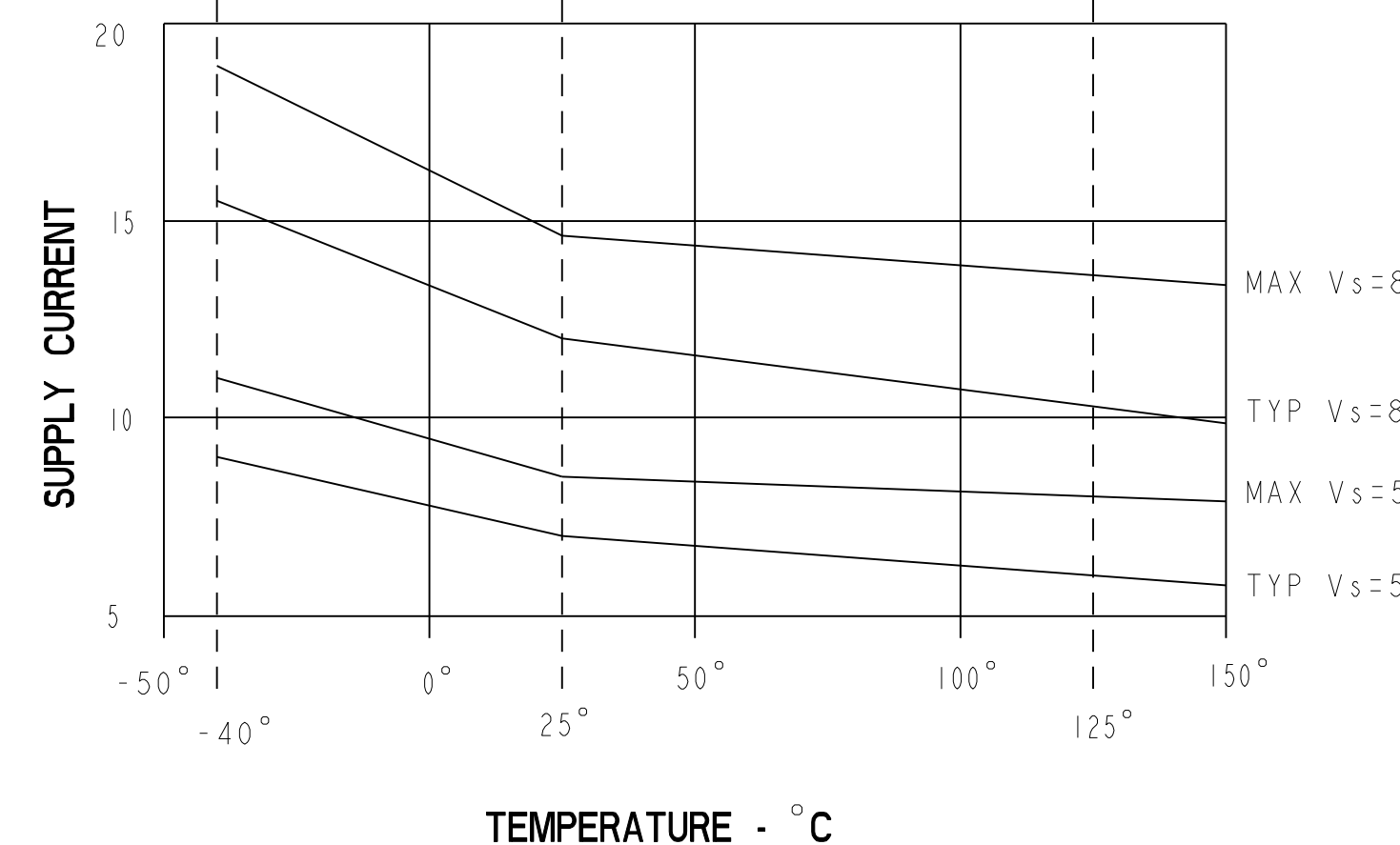

TYPICAL FREQUENCY RESPONSE
RL-33k PARALLEL WITH 100pF

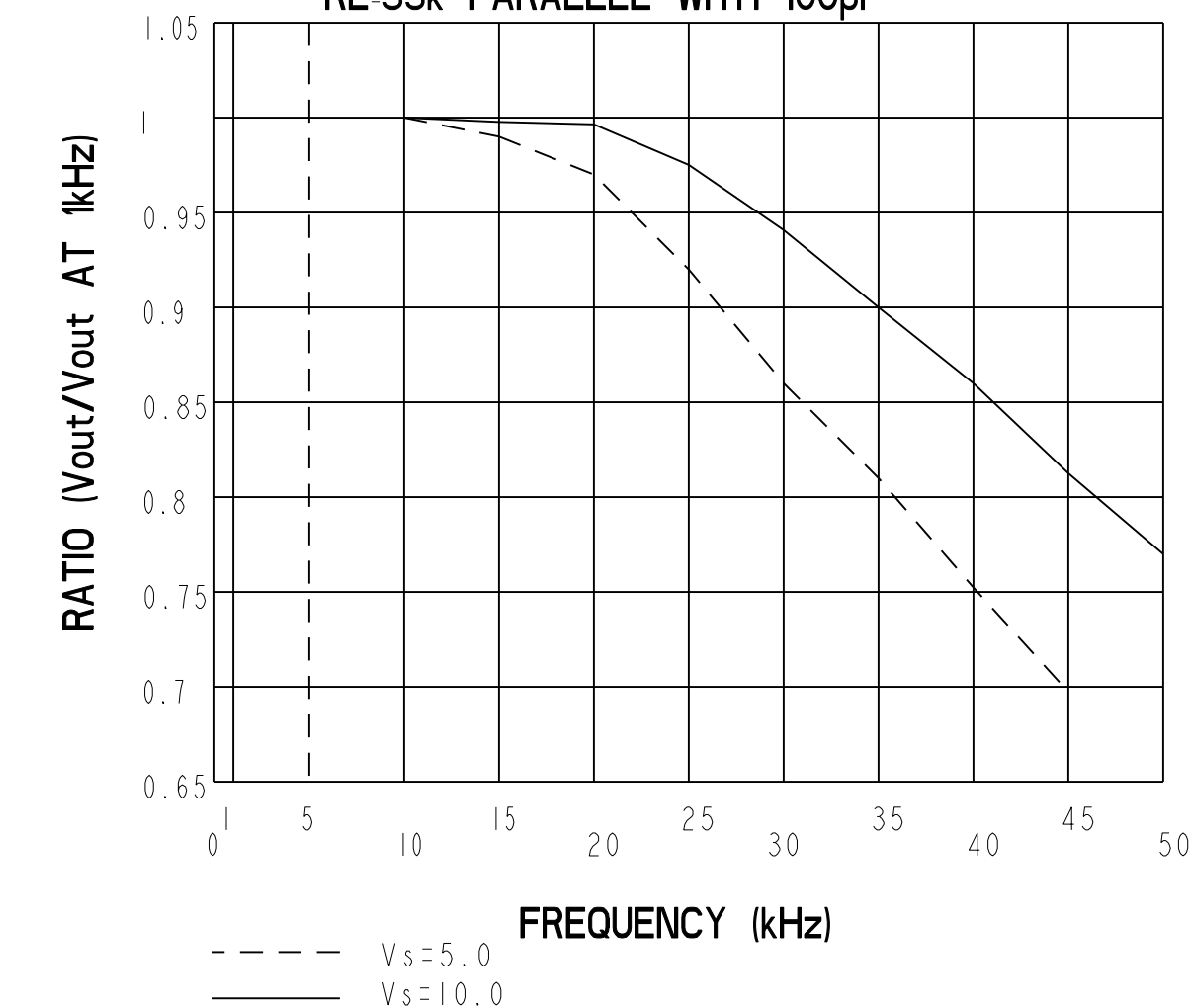

MAXIMUM ALLOWABLE AMBIENT TEMPERATURE

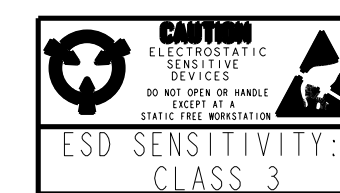
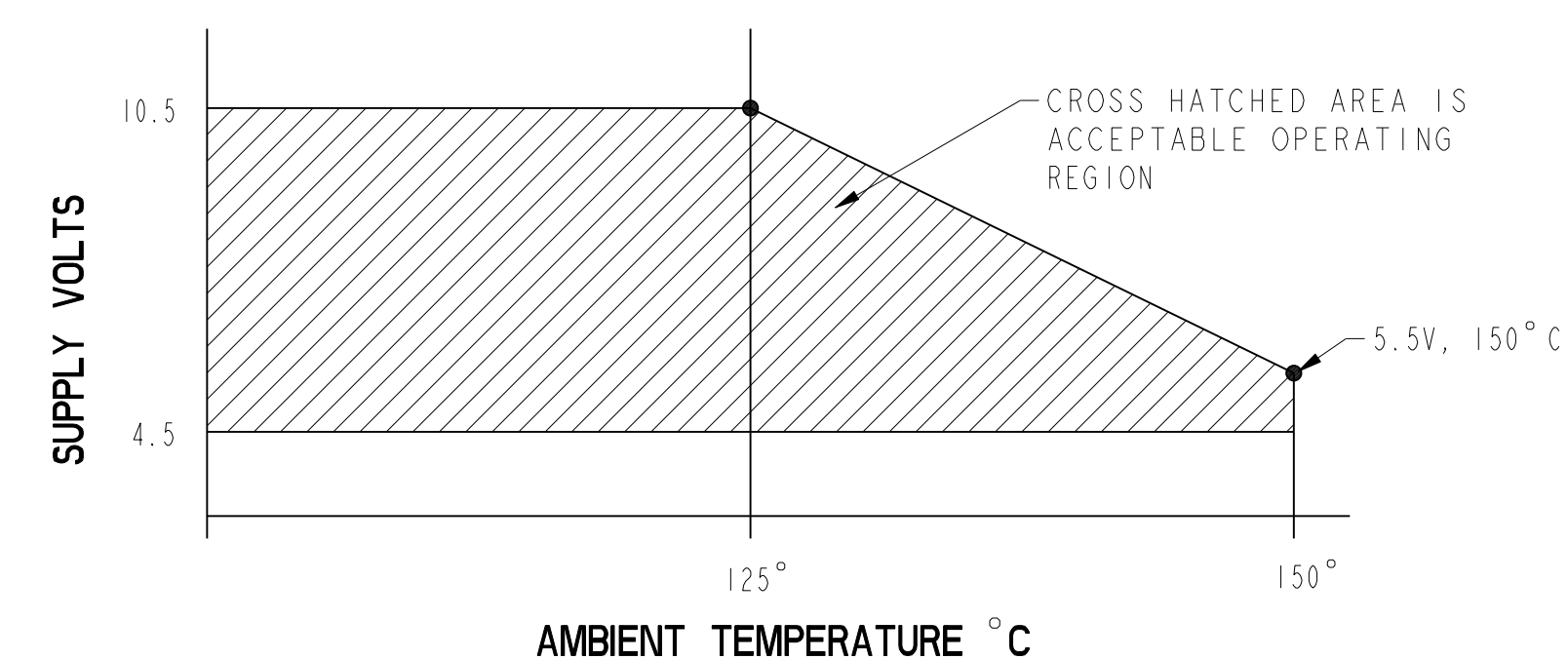

THIS DRAWING COVERS A PROPRIETARY ITEM AND IS THE PROPERTY OF MICRO SWITCH, A DIVISION OF HONEYWELL. THIS DRAWING IS NOT TO BE COPIED OR USED WITHOUT THE APPROVAL OF MICRO SWITCH.
FED. MFG. CODE 91929
MICRO SWITCH a Honeywell Division
MINIATURE RATIO-METRIC LINEAR HALL EFFECT SENSOR
SS495 SERIES CHART 1

| | | |
|------------------------|---|--------------------------|
| THIRD ANGLE PROJECTION | SCALE | DO NOT SCALE PRINT |
| SCALE: NONE | UNLESS OTHERWISE SPECIFIED TOLERANCES ARE | ONE PLACE (.0) +.030 |
| | | TWO PLACE (.00) +.015 |
| | | THREE PLACE (.000) +.005 |
| | | ANGLES +2° |
| | WEIGHT | |

PTC/CAD 2D
 DRAWN: C.S.L.
 CHECK: L.A.
 APPROVED: S.A.V.
 DATE: 4 APR 02
 RELEASE NO. PR-21283
 REVISIONS:
 14
 ISSUE: 14
 DRAWING NUMBER: 14
 PAGE: 2 OF 5
 DATE: 26 OCT 01

CHARACTERISTICS ARE AT $V_s=5.00$ WITH 4.7K OUTPUT TO MINUS WITH $T_A = -40^\circ\text{C}$ TO $+125^\circ\text{C}$ UNLESS OTHERWISE SPECIFIED

SS495A1

SS495 SERIES CHART 1

| PARAMETER | CONDITIONS | MIN | TYP | MAX | UNITS |
|-------------------------------|---|-------------|------------|------------|-----------|
| SENSITIVITY | $T_A = 25^\circ\text{C}$ | 3.031 | 3.125 | 3.219 | mV/GAUSS |
| NULL | $T_A = 25^\circ\text{C}$ | 2.425 | 2.50 | 2.575 | VOLTS |
| SUPPLY CURRENT | $T_A = 25^\circ\text{C}$ | | 7 | 8.7 | mA |
| OUTPUT CURRENT SOURCE | $V_s > 4.5$ | 1mA | 1.5mA | | |
| | SINK | $V_s > 4.5$ | .6mA | 1.5mA | |
| | SINK | $V_s > 5.0$ | 1mA | 1.5mA | |
| RESPONSE TIME | | | 3μS | | |
| OUTPUT VOLTAGE SWING | VOM - | | .4 | .2 | VOLTS |
| | VOM + | +B APPLIED | $V_s - .4$ | $V_s - .2$ | VOLTS |
| B LIMITS FOR LINEAR OPERATION | -B MAX | -600 | -670 | | GAUSS |
| | +B MAX | +600 | +670 | | GAUSS |
| V_{null} DRIFT | $B = 0, T_A = 25^\circ\text{C}$ TO 125°C | -.04 | | +.04 | % / °C |
| V_{null} DRIFT | $B = 0, T_A = +125^\circ\text{C}$ TO $+150^\circ\text{C}$ | -.08 | | +.08 | % / °C |
| SENSITIVITY DRIFT | $T_A = +25^\circ\text{C}$ TO $+150^\circ\text{C}$ | -.01 | | +.05 | % / °C |
| SENSITIVITY DRIFT | $T_A = -40^\circ\text{C}$ TO $+25^\circ\text{C}$ | 0 | | +.06 | % / °C |
| LINEARITY | $B = -600$ TO $+600$ | 0 | -1.0 | -1.5 | % OF SPAN |
| SUPPLY VOLTAGE | -40°C TO $+125^\circ\text{C}$ | 4.5 | 5.0 | 10.5 | VOLTS |
| OPERATING TEMP | SEE MAX TEMPERATURE CHART | -40 | | +150 | °C |

BLOCK DIAGRAM CURRENT SINKING OR SOURCING OUTPUT

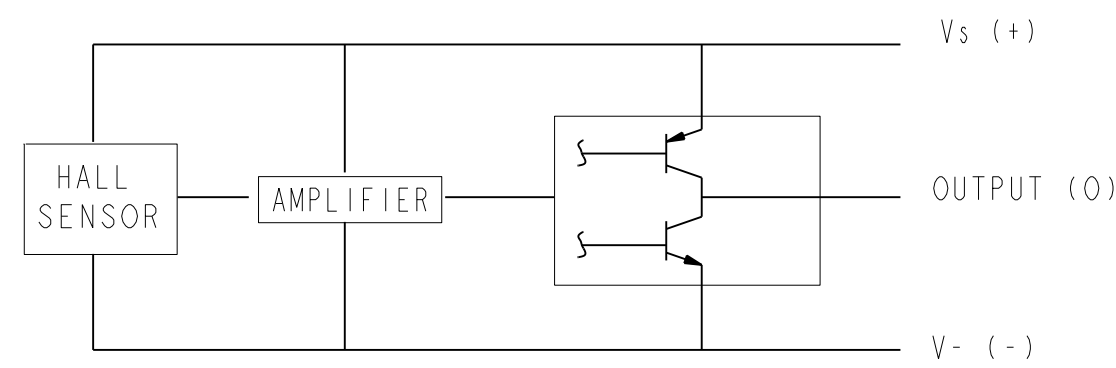

ABSOLUTE MAXIMUM CHARACTERISTICS

| CHARACTERISTIC | SYMBOL | TEST CONDITION | MIN | MAX | UNITS |
|----------------|-----------|------------------------|------|-----|-------|
| SUPPLY VOLTAGE | V_{cc} | | -0.5 | 11 | V |
| OUTPUT VOLTAGE | V_{out} | | -0.5 | 11 | V |
| OUTPUT CURRENT | I_{out} | SOURCE OR SINK | | 10 | mA |
| TEMPERATURE | T_A | OPERATING | -55 | 150 | °C |
| | T_s | STORAGE ($V_{cc}=0$) | -55 | 165 | °C |

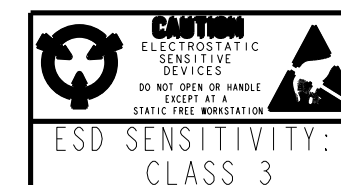
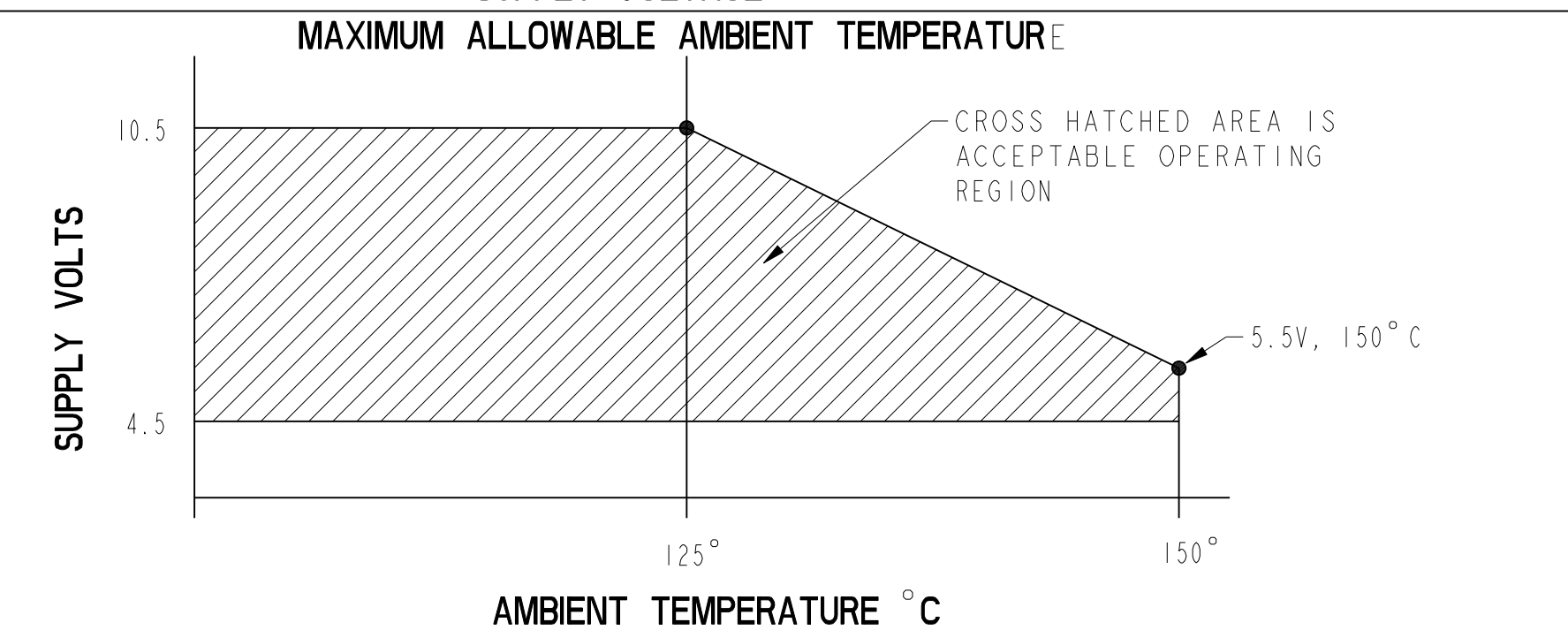
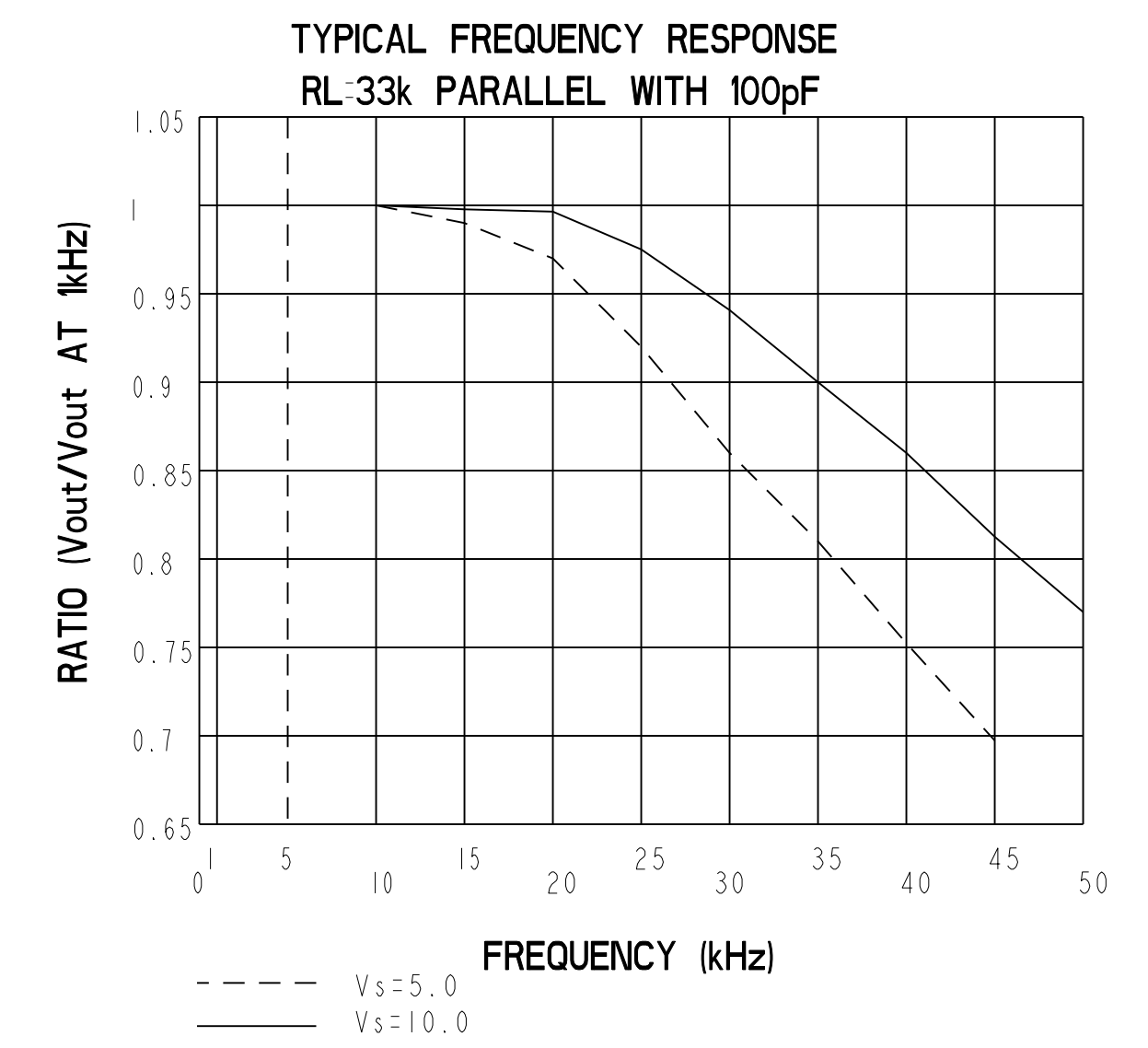
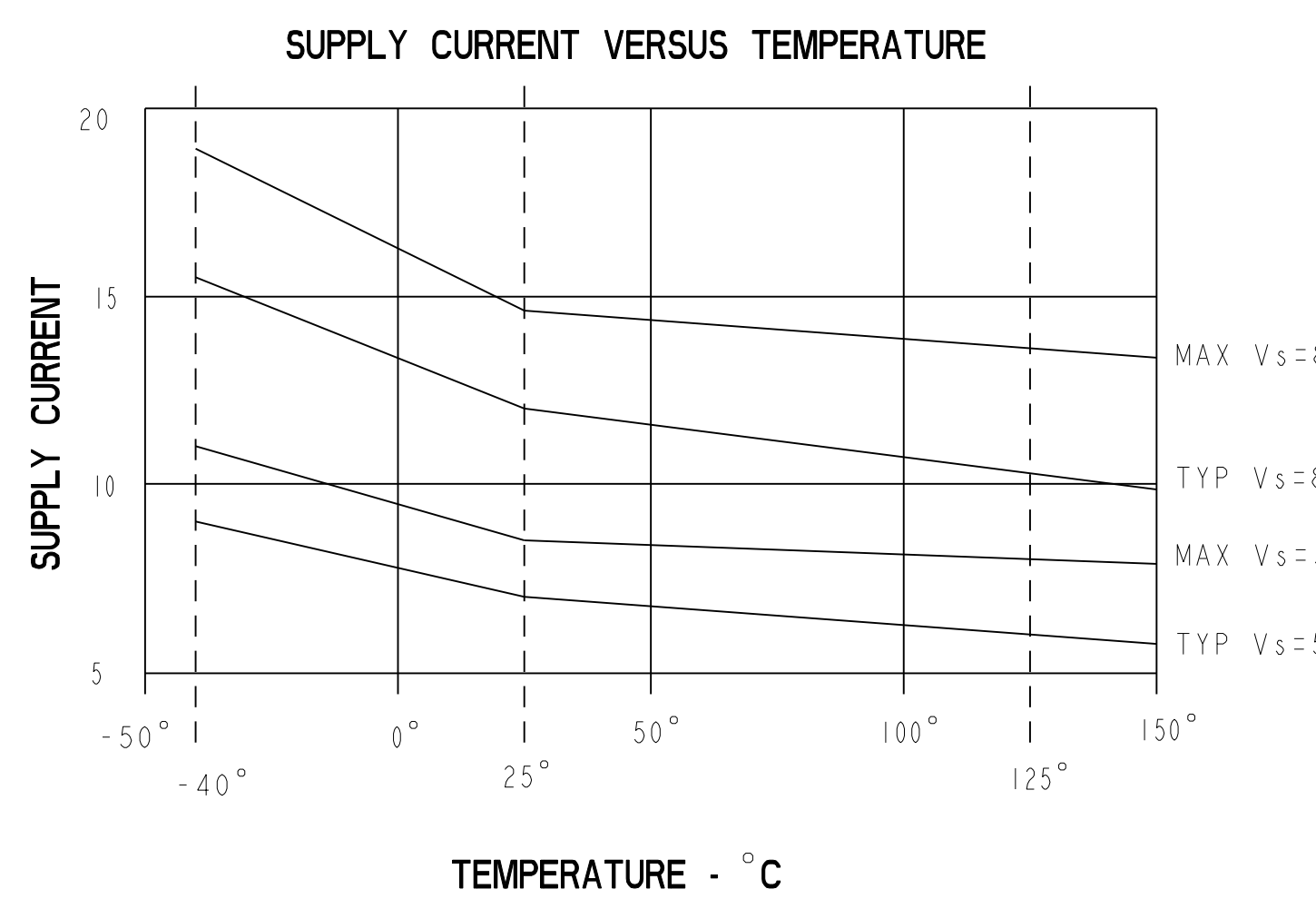
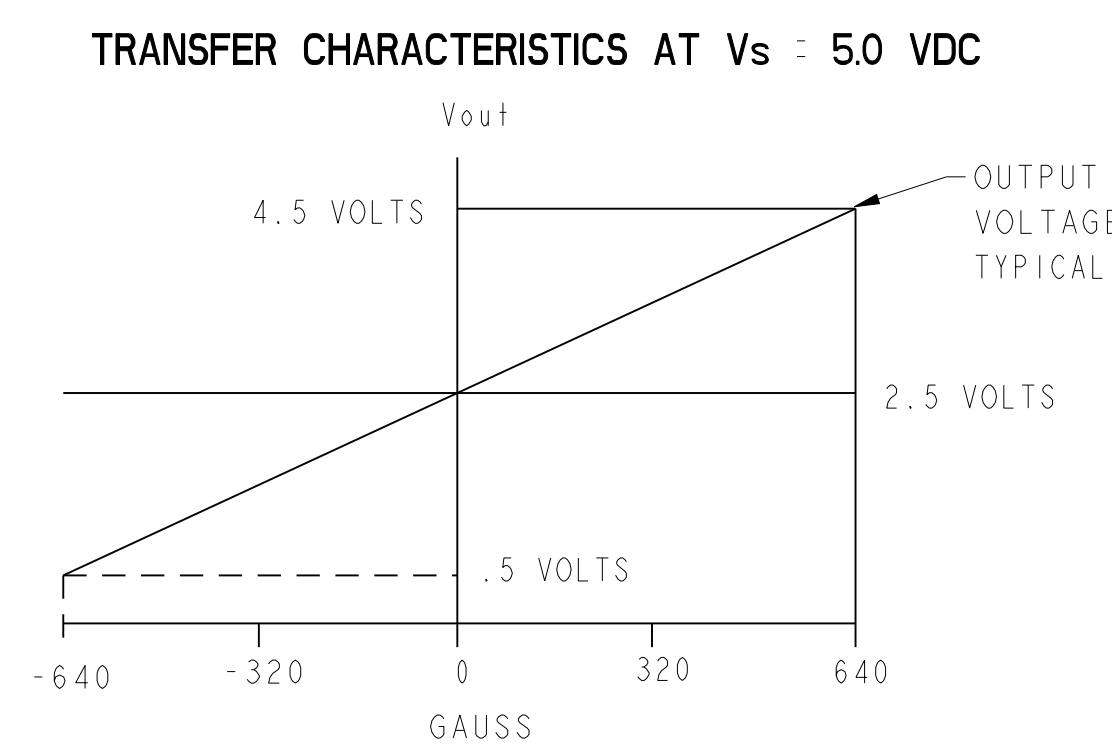
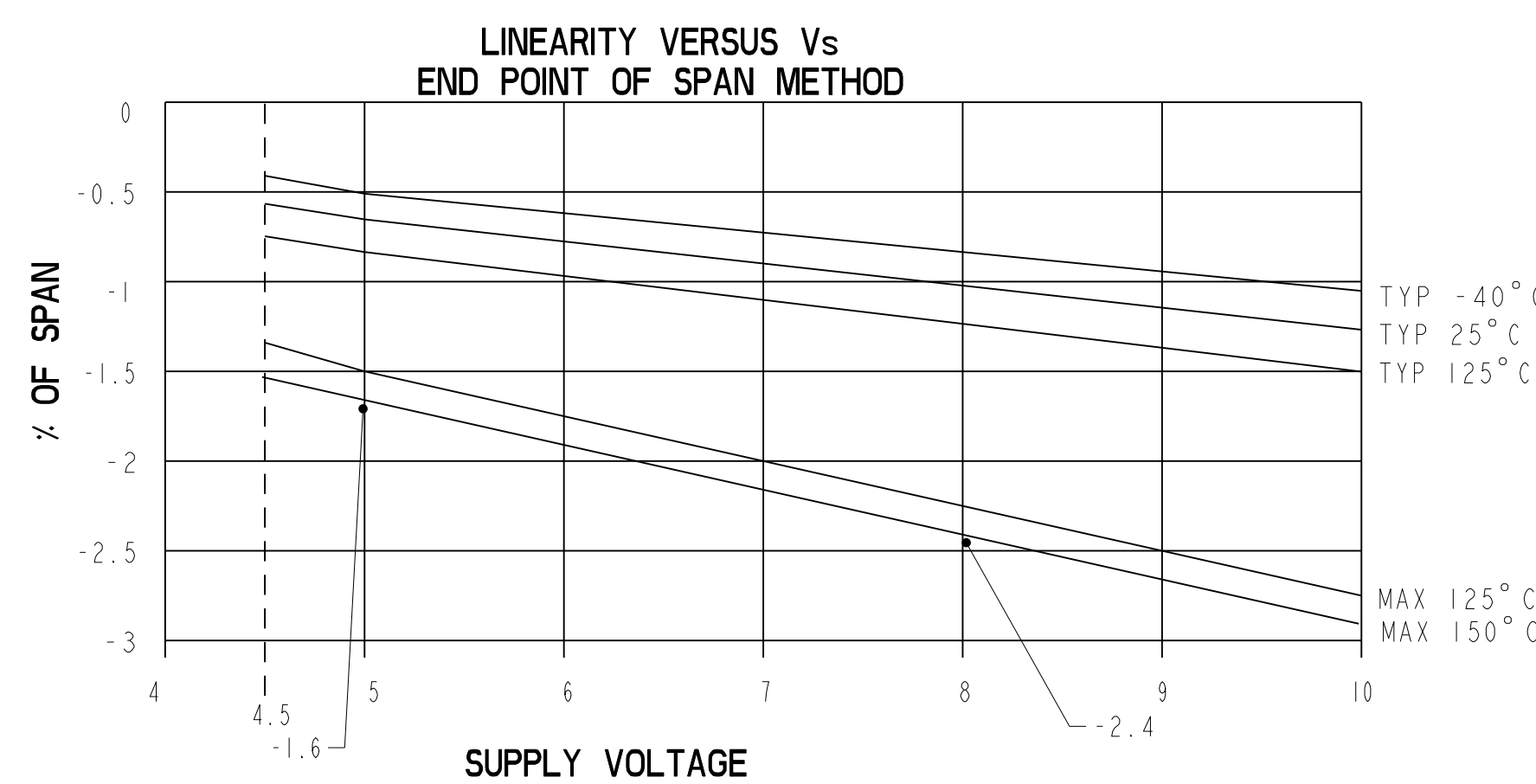
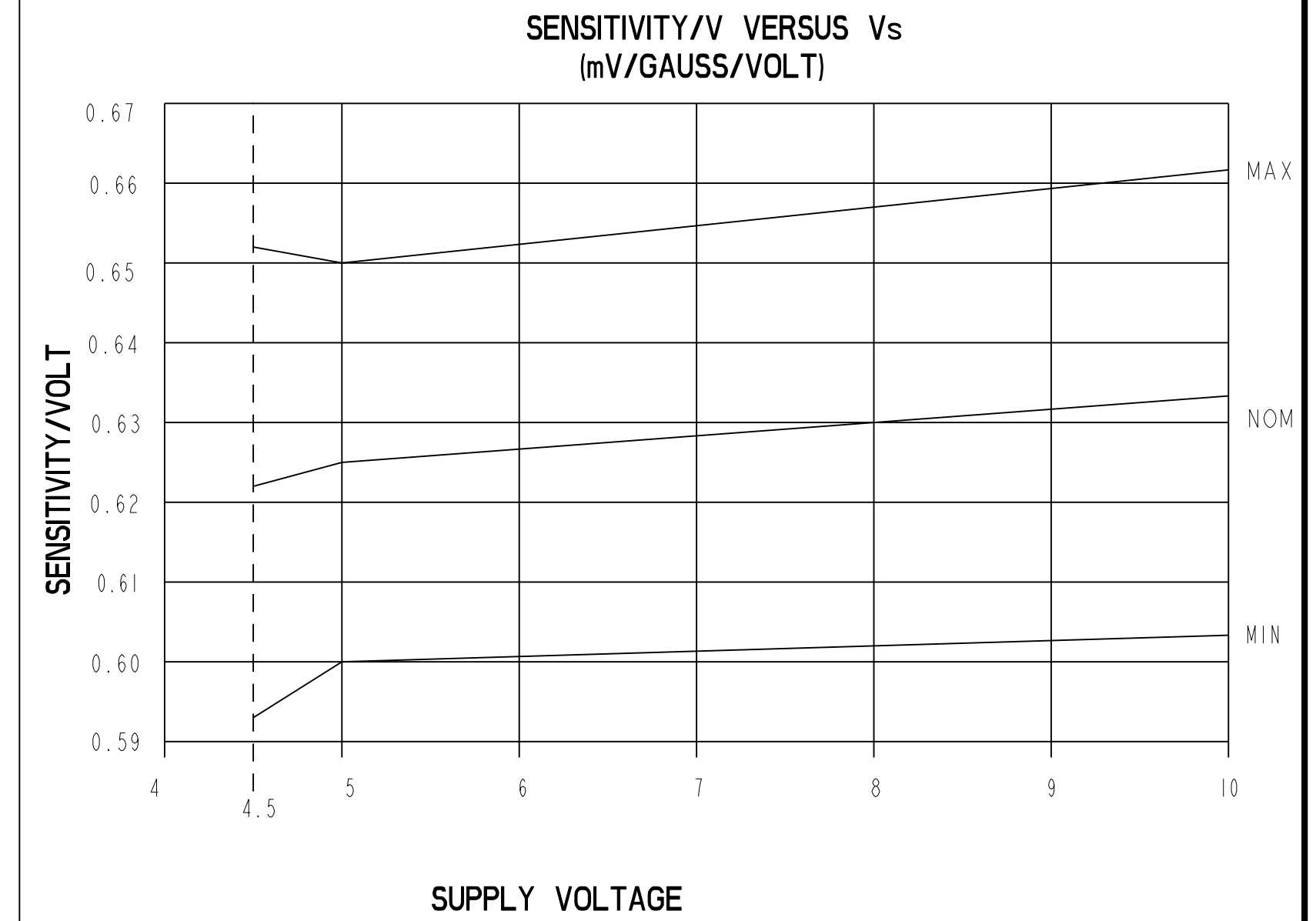
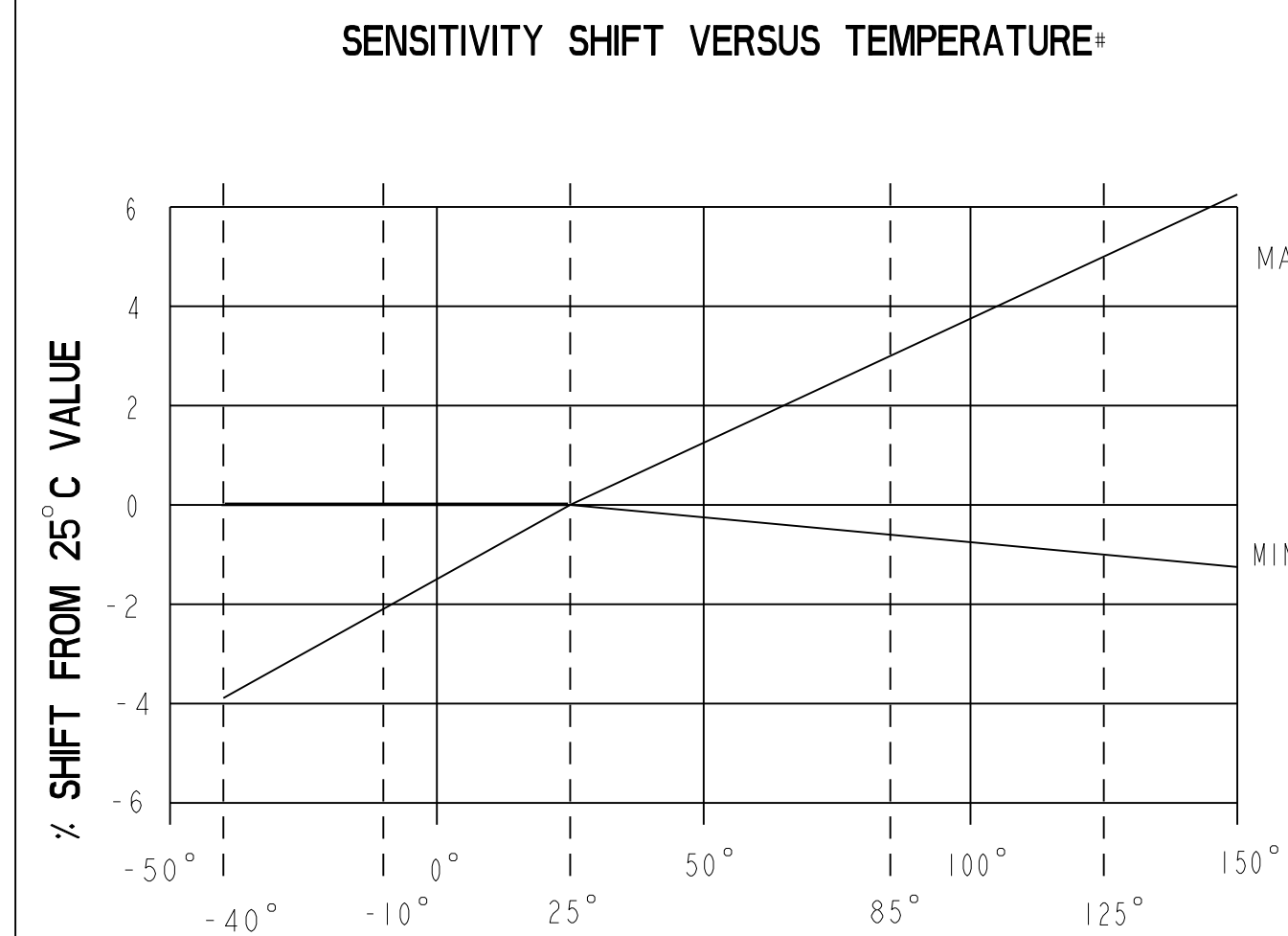
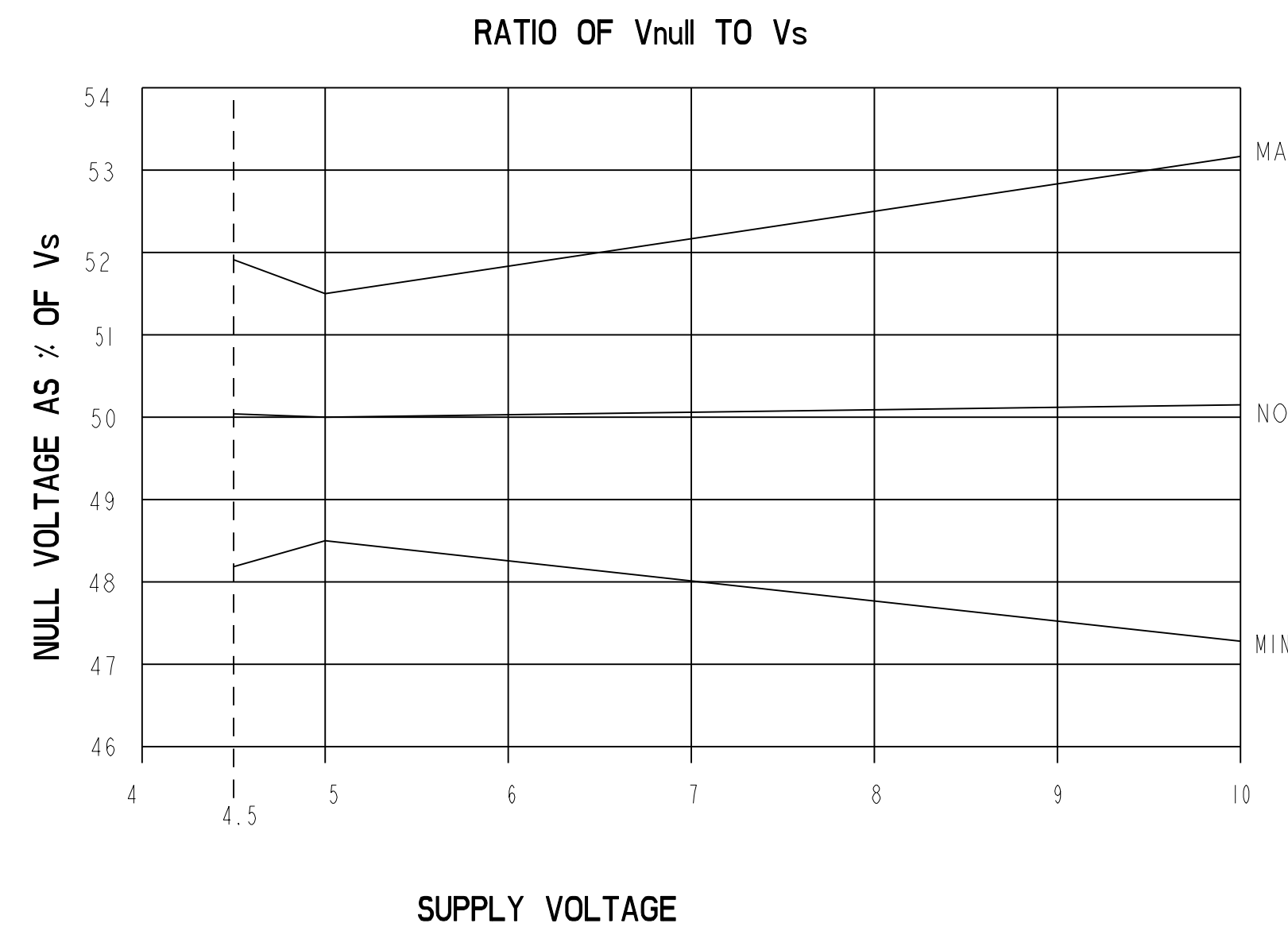
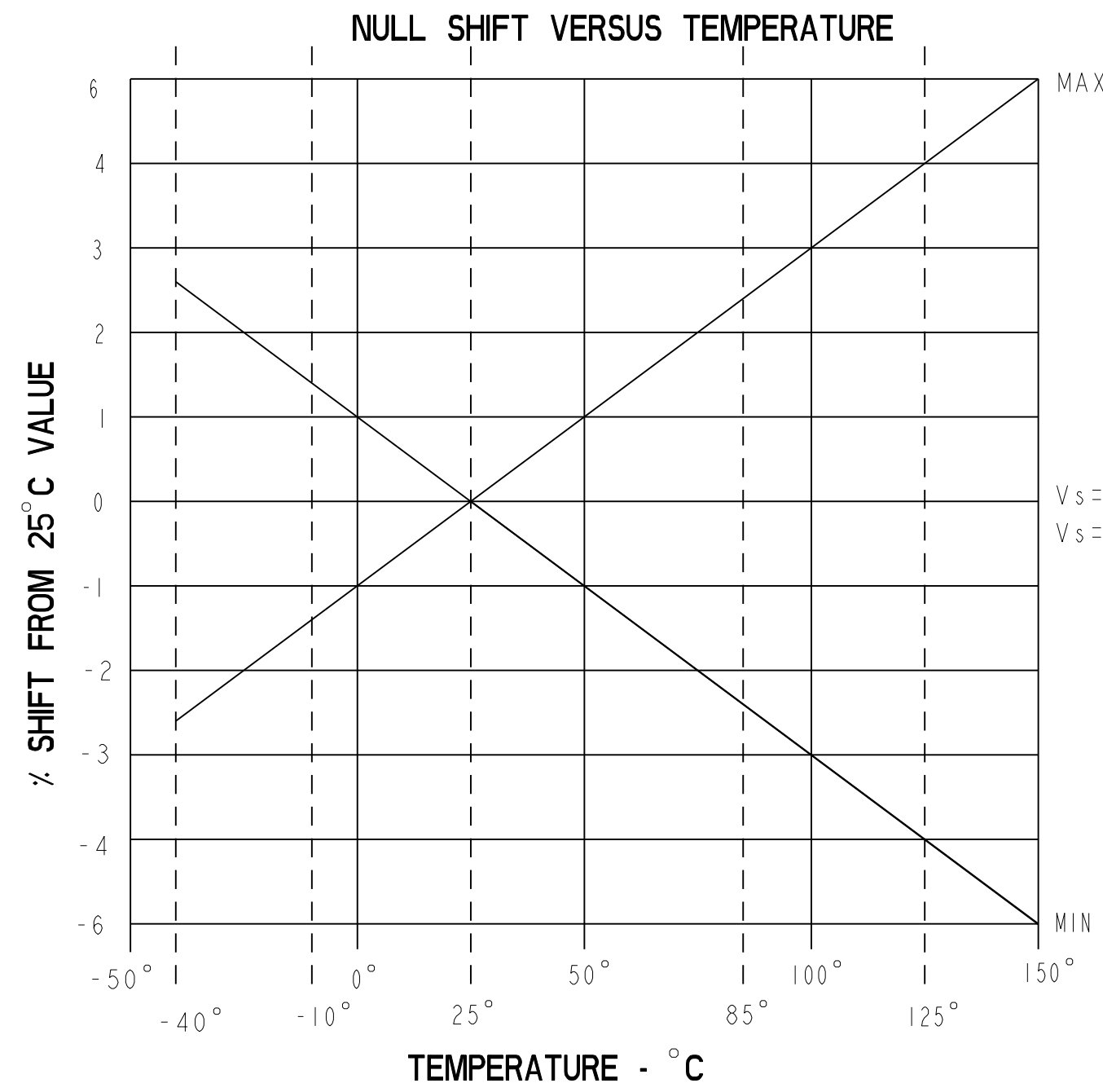

THIS DRAWING COVERS A PROPRIETARY ITEM AND IS THE PROPERTY OF MICRO SWITCH, A DIVISION OF HONEYWELL. THIS DRAWING IS NOT TO BE COPIED OR USED WITHOUT THE APPROVAL OF MICRO SWITCH.
 FED. MFG. CODE 91929
MICRO SWITCH
 a Honeywell Division
 CATALOG LISTING
MINIATURE RATIO-METRIC LINEAR HALL EFFECT SENSOR
SS495 SERIES CHART 1

| | |
|---|--------------|
| THIRD ANGLE PROJECTION | |
| SCALE | NONE |
| DO NOT SCALE PRINT | |
| UNLESS OTHERWISE SPECIFIED TOLERANCES ARE | |
| ONE PLACE | (.0) +.030 |
| TWO PLACE | (.00) +.015 |
| THREE PLACE | (.000) +.005 |
| ANGLES | +2° |
| WEIGHT | |

ANSI Y14.5M-1982 APPLIES

CHARACTERISTICS ARE AT $V_s=5.00$ WITH 4.7K OUTPUT TO MINUS WITH $T_A: -40^\circ\text{C}$ TO $+125^\circ\text{C}$ UNLESS OTHERWISE SPECIFIED

SS495A2

SS495 SERIES CHART 1

| PARAMETER | CONDITIONS | MIN | TYP | MAX | UNITS |
|-------------------------------|---|------------|------------|-------|-----------|
| SENSITIVITY | $T_A = 25^\circ\text{C}$ | 2.969 | 3.125 | 3.281 | mV/GAUSS |
| NULL | $T_A = 25^\circ\text{C}$ | 2.400 | 2.50 | 2.600 | VOLTS |
| SUPPLY CURRENT | $T_A = 25^\circ\text{C}$ | | 7 | 8.7 | mA |
| OUTPUT CURRENT SOURCE | $V_s > 4.5$ | 1mA | 1.5mA | | |
| SINK | $V_s > 4.5$ | .6mA | 1.5mA | | |
| SINK | $V_s > 5.0$ | 1mA | 1.5mA | | |
| RESPONSE TIME | | | 3μS | | |
| OUTPUT VOLTAGE SWING | | | | | |
| VOM - | -B APPLIED | .4 | .2 | | VOLTS |
| VOM + | +B APPLIED | $V_s - .4$ | $V_s - .2$ | | VOLTS |
| B LIMITS FOR LINEAR OPERATION | | | | | |
| -B MAX | | -600 | -670 | | GAUSS |
| +B MAX | | +600 | +670 | | GAUSS |
| V_{null} DRIFT | $B = 0, T_A = 25^\circ\text{C}$ TO 125°C | -.07 | | +.07 | % / °C |
| V_{null} DRIFT | $B = 0, T_A = +125^\circ\text{C}$ TO $+150^\circ\text{C}$ | -.08 | | +.08 | % / °C |
| SENSITIVITY DRIFT | $T_A = +25^\circ\text{C}$ TO $+150^\circ\text{C}$ | -.02 | | +.06 | % / °C |
| SENSITIVITY DRIFT | $T_A = -40^\circ\text{C}$ TO $+25^\circ\text{C}$ | -.01 | | +.07 | % / °C |
| LINEARITY | $B = -600$ TO $+600$ | 0 | -1.0 | -1.5 | % OF SPAN |
| SUPPLY VOLTAGE | -40°C TO $+125^\circ\text{C}$ | 4.5 | 5.0 | 10.5 | VOLTS |
| OPERATING TEMP | SEE MAX TEMPERATURE CHART | -40 | | +150 | °C |

BLOCK DIAGRAM CURRENT SINKING OR SOURCING OUTPUT

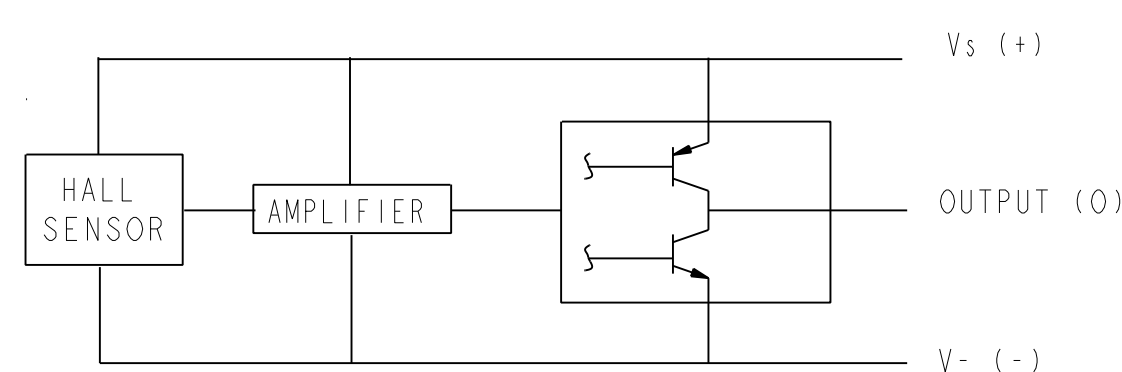

ABSOLUTE MAXIMUM CHARACTERISTICS

| CHARACTERISTIC | SYMBOL | TEST CONDITION | MIN | MAX | UNITS |
|----------------|-----------|------------------------|------|-----|-------|
| SUPPLY VOLTAGE | V_{cc} | | -0.5 | 11 | V |
| OUTPUT VOLTAGE | V_{out} | | -0.5 | 11 | V |
| OUTPUT CURRENT | I_{out} | SOURCE OR SINK | 10 | | mA |
| TEMPERATURE | T_A | OPERATING | -55 | 150 | °C |
| | T_s | STORAGE ($V_{cc}=0$) | -55 | 165 | °C |

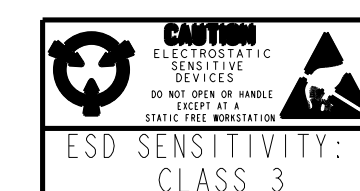
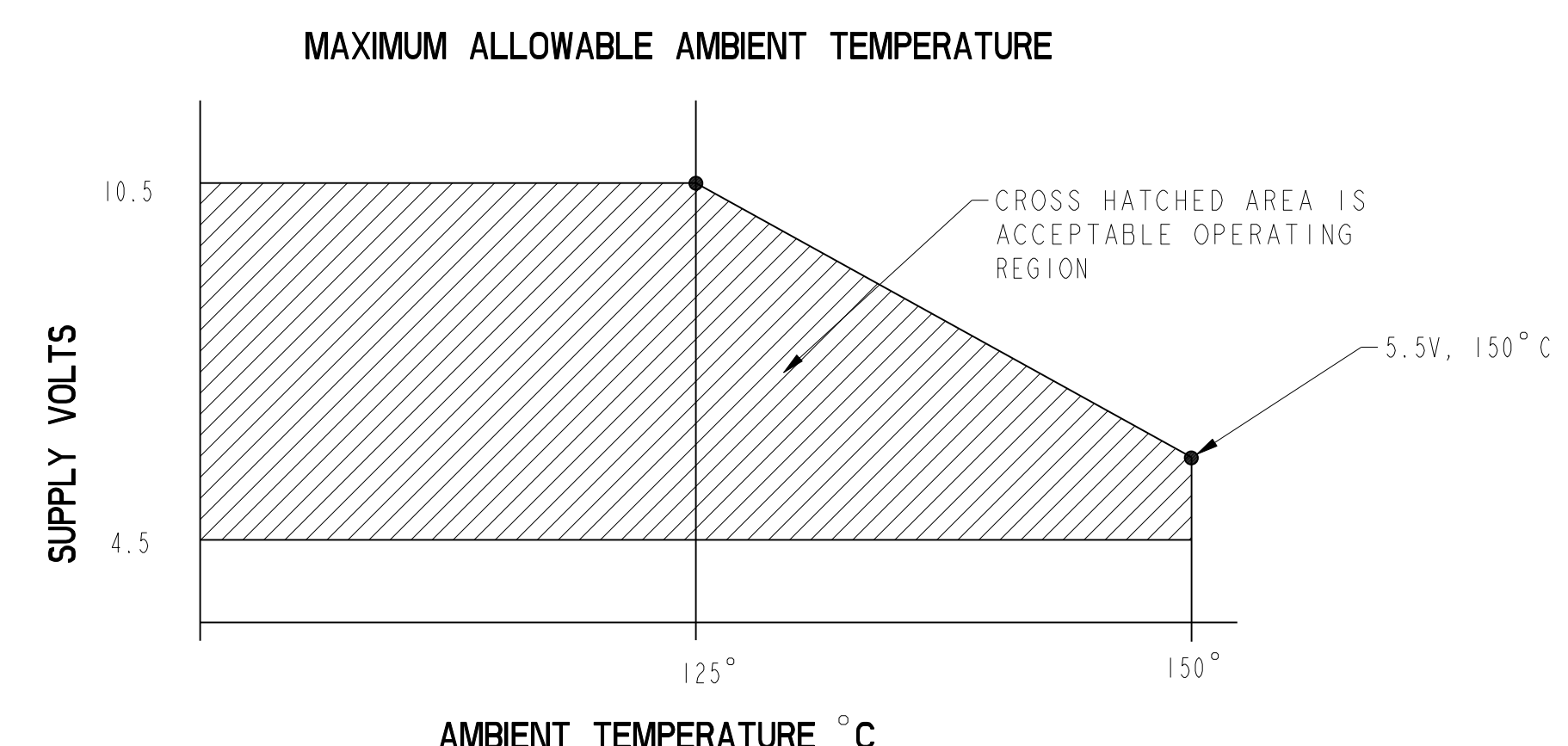
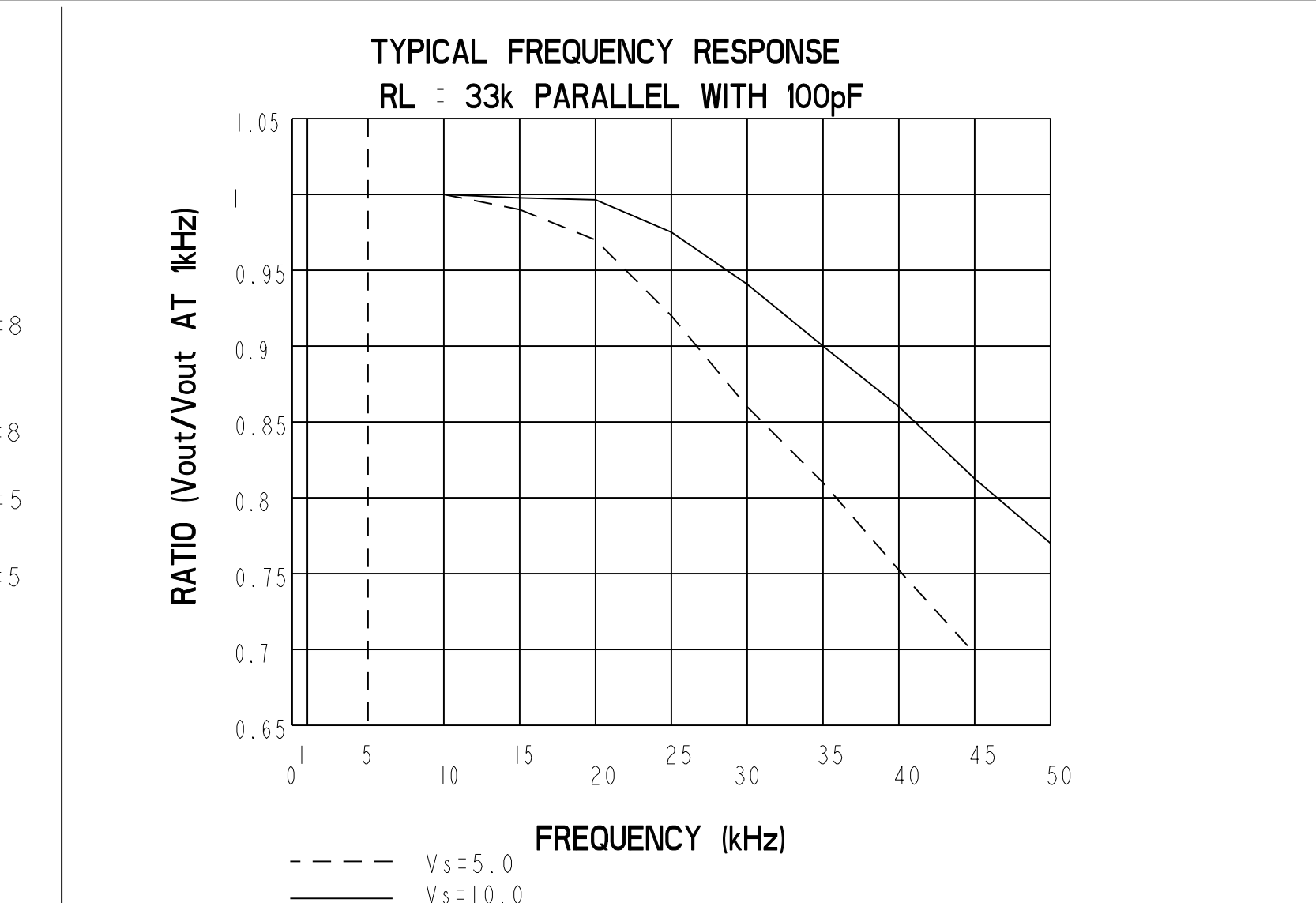
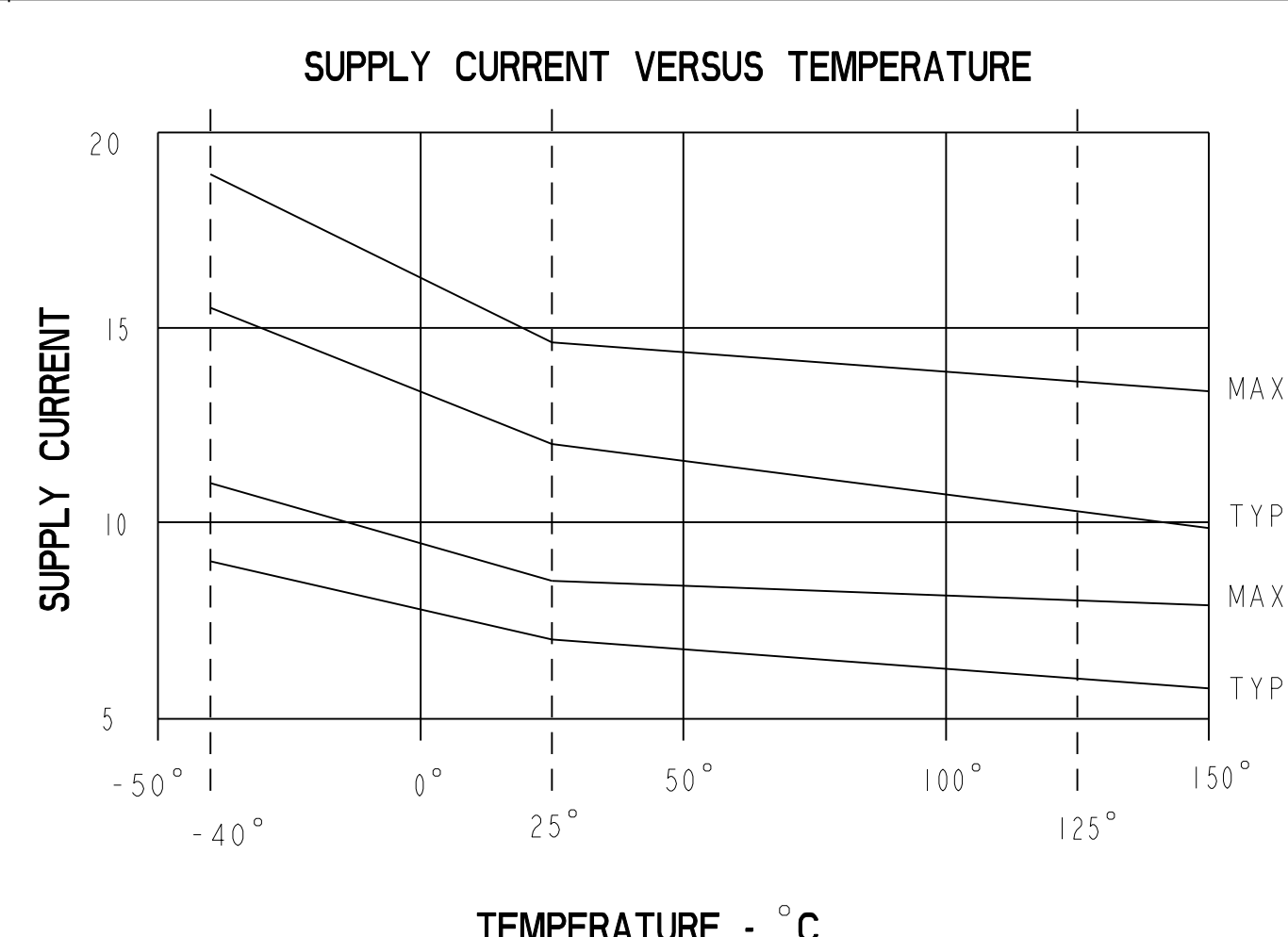
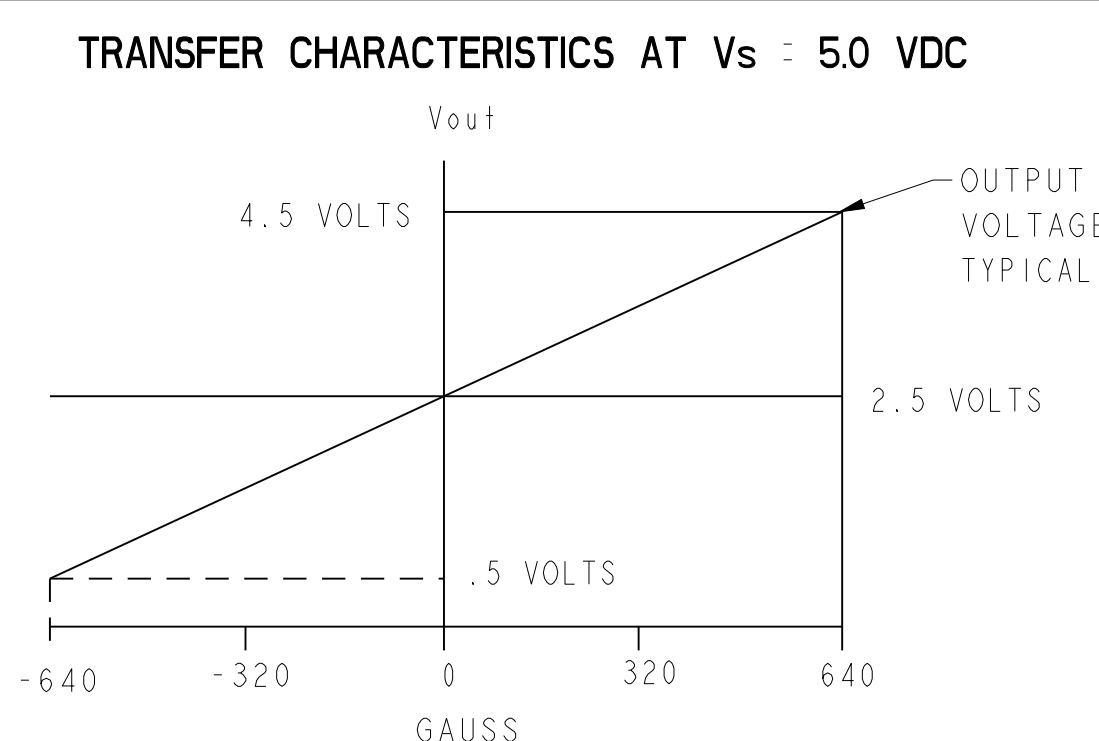
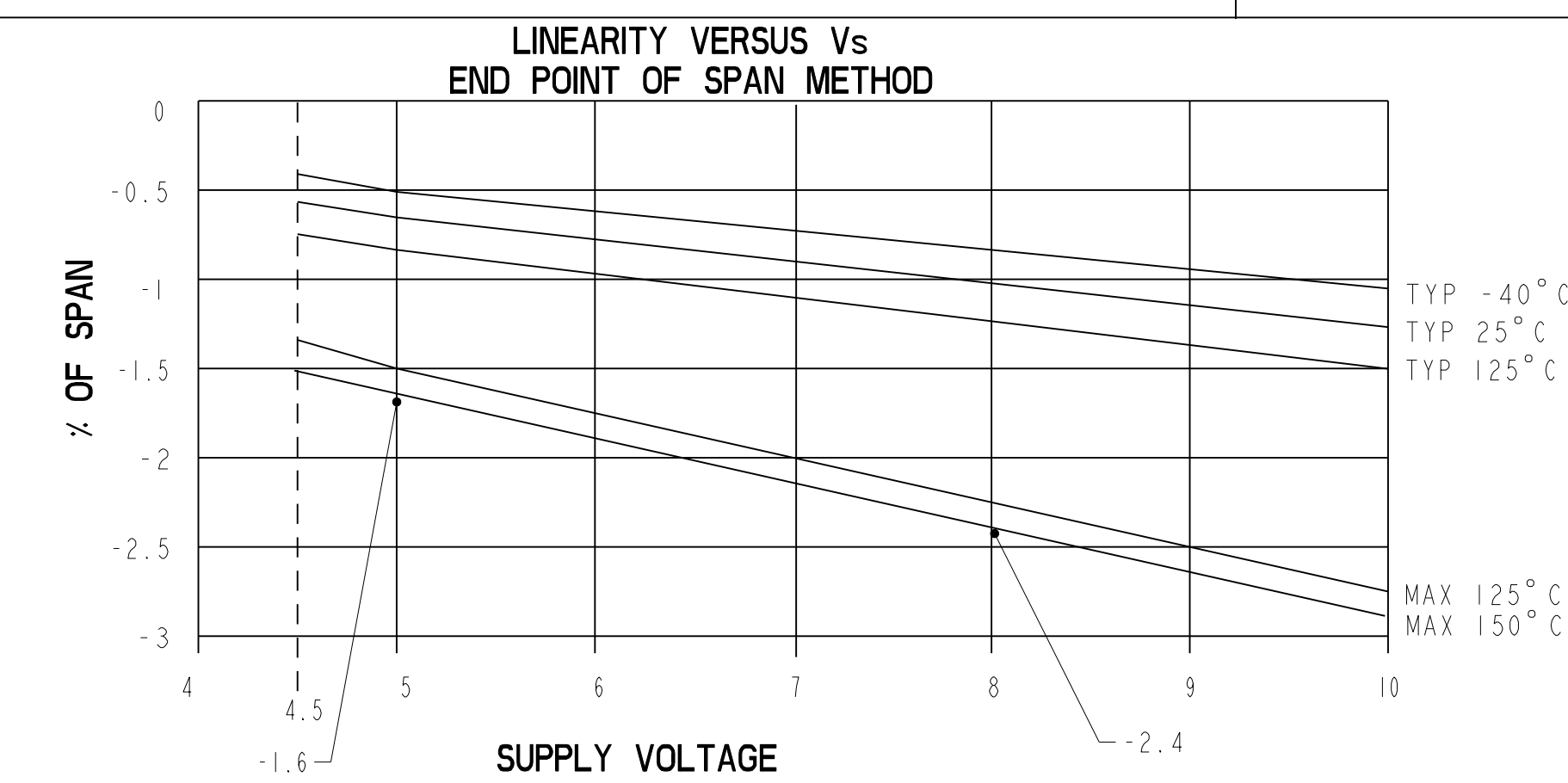
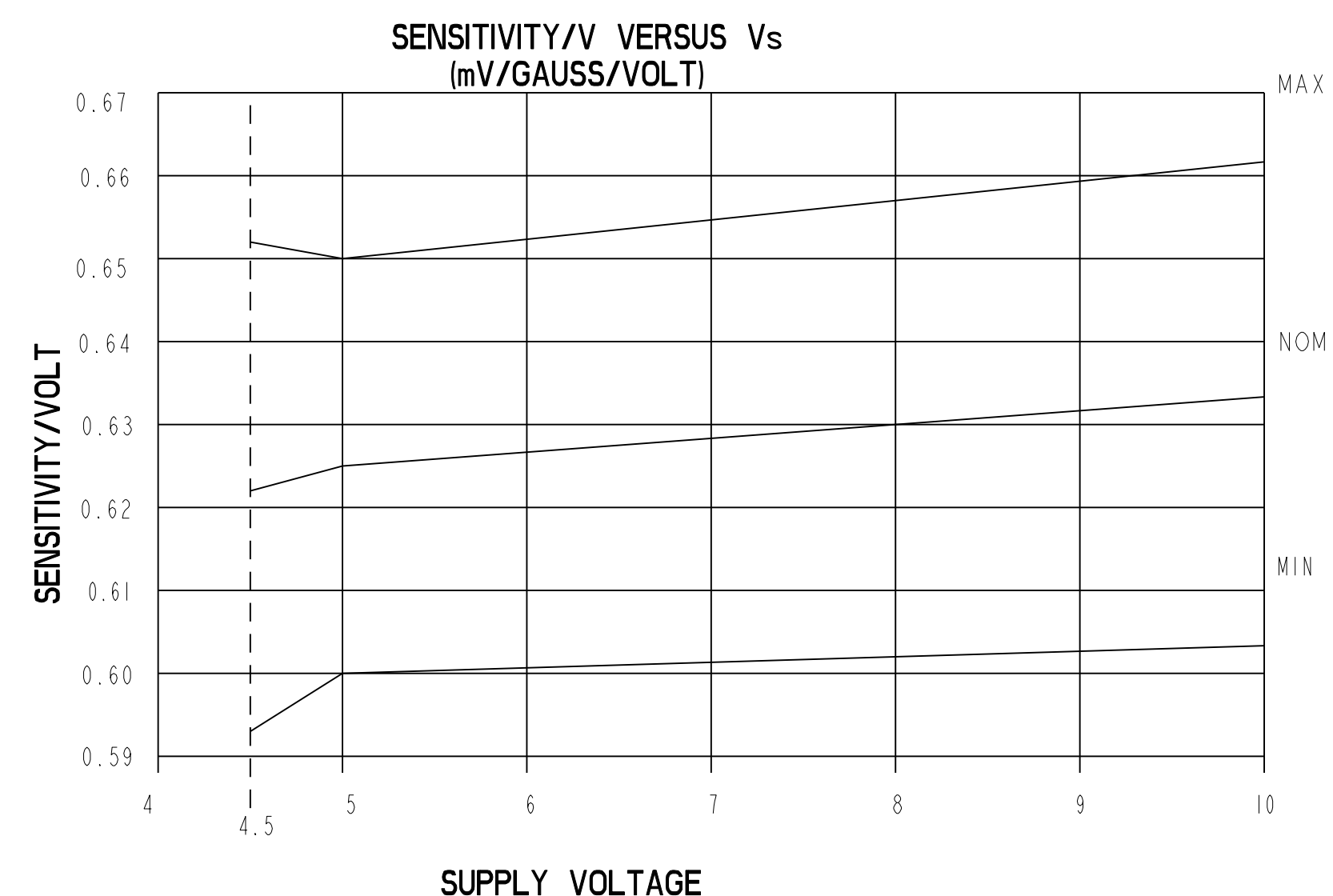
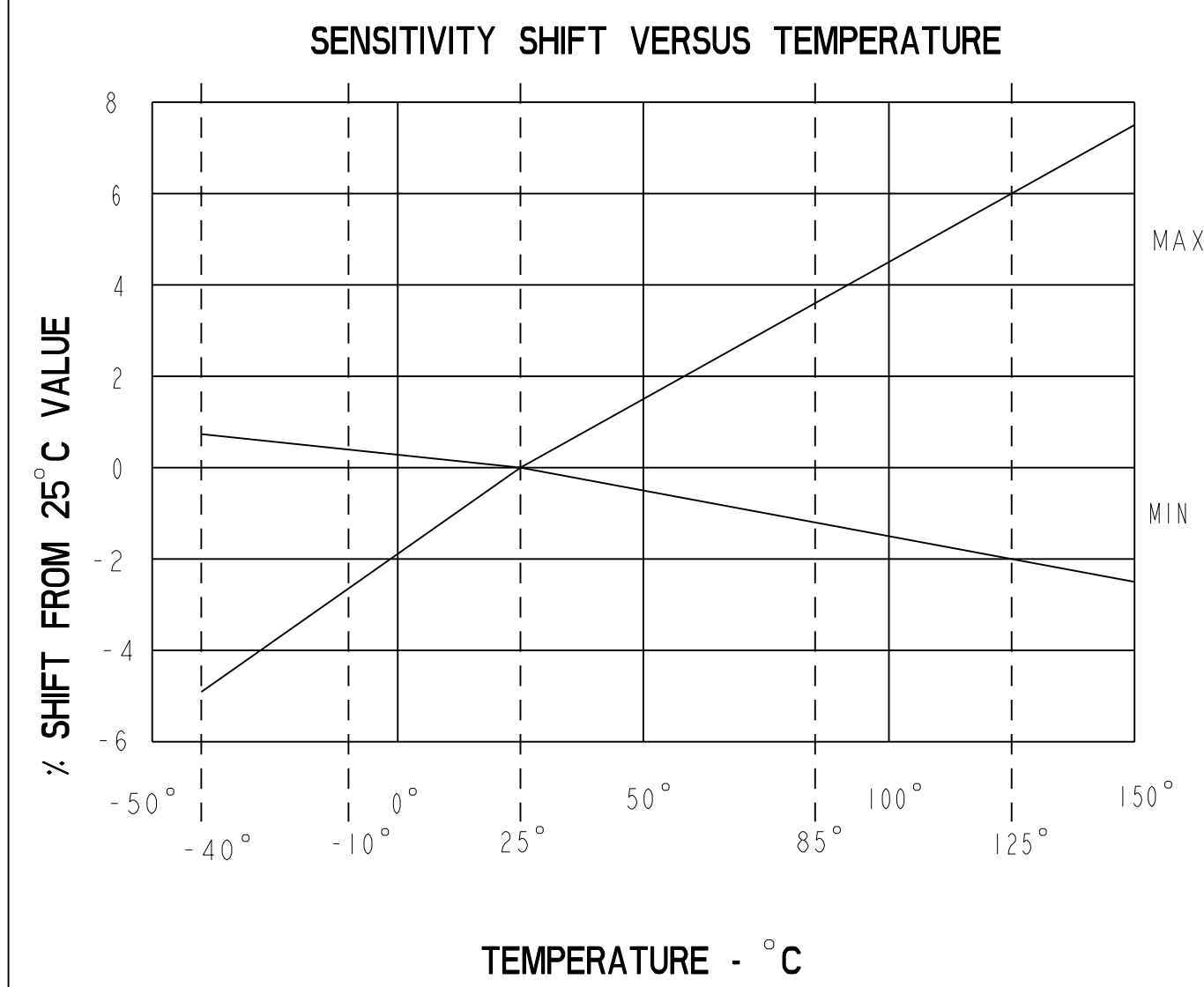
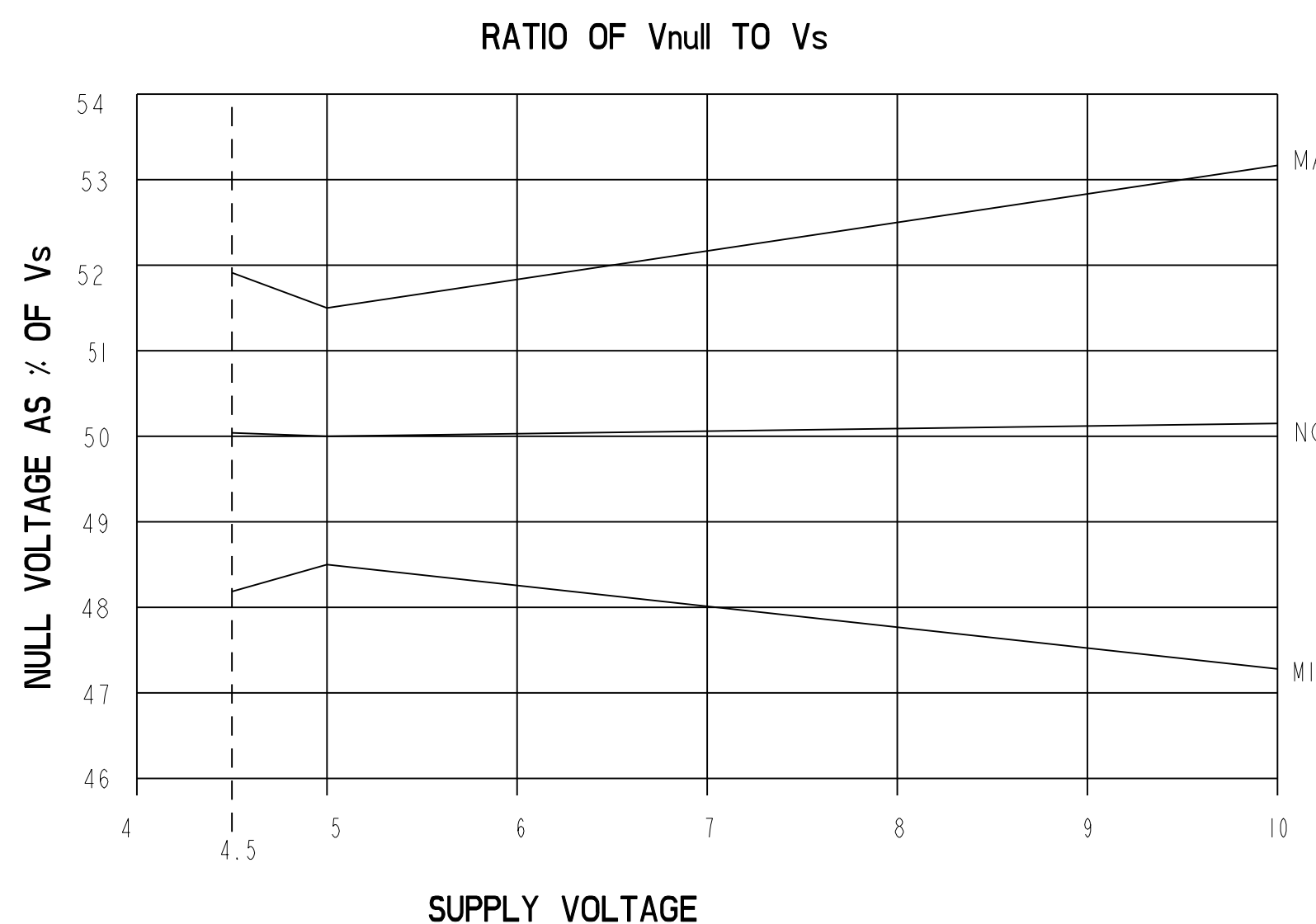
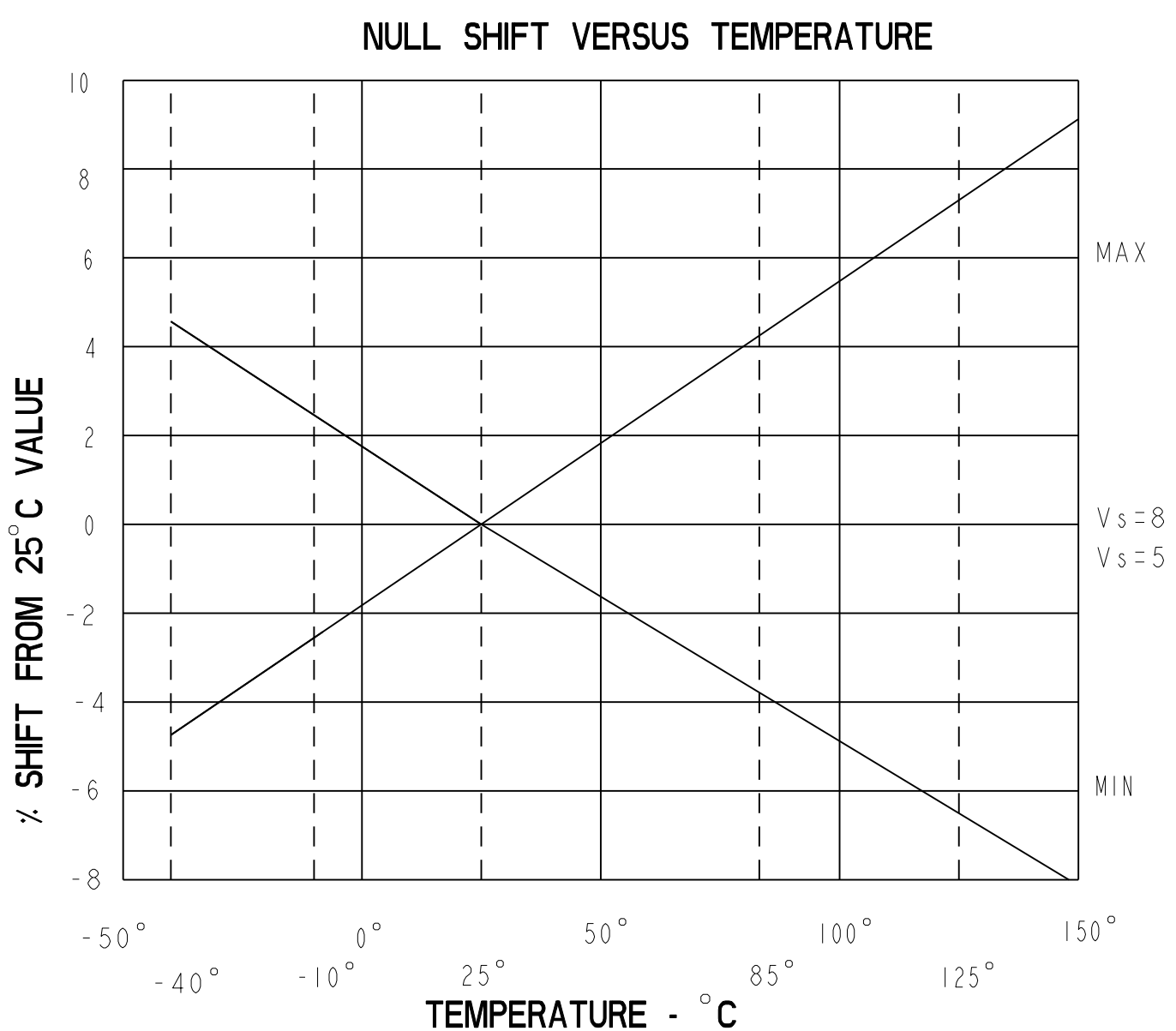

THIS DRAWING COVERS A PROPRIETARY ITEM AND IS THE PROPERTY OF MICRO SWITCH, A DIVISION OF HONEYWELL. THIS DRAWING IS NOT TO BE COPIED OR USED WITHOUT THE APPROVAL OF MICRO SWITCH.

FED. MFG. CODE 91929

MICRO SWITCH
a Honeywell Division

MINIATURE RATIO-METRIC LINEAR HALL EFFECT SENSOR

SS495 SERIES CHART 1

ONE PLACE (.0) +.030
TWO PLACE (.00) +.015
THREE PLACE (.000) +.005
ANGLES +2°

THIRD ANGLE PROJECTION
SCALE NONE
DO NOT SCALE PRINT
UNLESS OTHERWISE SPECIFIED TOLERANCES ARE

WEIGHT

PTC/CAD 20
DRAWN
C.S.L. 15 APR 02
CHECKED
S.A.V. 5 APR 02
RELEASE NO. PR-22532
SERIES 4 OF 5
SS495 SERIES CHART 1
ISSUE 14

CHARACTERISTICS ARE AT $V_s=5.00$ WITH 4.7K OUTPUT TO MINUS WITH $T_A: -40^\circ\text{C}$ TO $+125^\circ\text{C}$ UNLESS OTHERWISE SPECIFIED

SS495B

SS495 SERIES CHART 1

| PARAMETER | CONDITIONS | MIN | TYP | MAX | UNITS |
|-------------------------------|---|------------|------------|-------|-----------|
| SENSITIVITY | $T_A = 25^\circ\text{C}$ | 2.875 | 3.125 | 3.375 | mV/GAUSS |
| NULL | $T_A = 25^\circ\text{C}$ | 2.35 | 2.50 | 2.650 | VOLTS |
| SUPPLY CURRENT | $T_A = 25^\circ\text{C}$ | | 7 | 8.7 | mA |
| OUTPUT CURRENT SOURCE | $V_s > 4.5$ | 1mA | 1.5mA | | |
| SINK | $V_s > 4.5$ | | .6mA | 1.5mA | |
| SINK | $V_s > 5.0$ | 1mA | 1.5mA | | |
| RESPONSE TIME | | | 3μS | | |
| OUTPUT VOLTAGE SWING | | | | | |
| VOM - | -B APPLIED | .4 | .2 | | VOLTS |
| VOM + | +B APPLIED | $V_s - .4$ | $V_s - .2$ | | VOLTS |
| B LIMITS FOR LINEAR OPERATION | | | | | GAUSS |
| -B MAX | | -600 | -670 | | |
| +B MAX | | +600 | +670 | | |
| V_{null} DRIFT | $B = 0, T_A = 25^\circ\text{C}$ TO 125°C | -.08 | | +.08 | % / °C |
| V_{null} DRIFT | $B = 0, T_A = +125^\circ\text{C}$ TO $+150^\circ\text{C}$ | -.08 | | +.08 | % / °C |
| SENSITIVITY DRIFT | $T_A = +25^\circ\text{C}$ TO $+150^\circ\text{C}$ | -.02 | | +.08 | % / °C |
| SENSITIVITY DRIFT | $T_A = -40^\circ\text{C}$ TO $+25^\circ\text{C}$ | -.02 | | +.08 | % / °C |
| LINEARITY | $B = -600$ TO $+600$ | 0 | -1.0 | -1.5 | % OF SPAN |
| SUPPLY VOLTAGE | -40°C TO $+125^\circ\text{C}$ | 4.5 | 5.0 | 10.5 | VOLTS |
| OPERATING TEMP | SEE MAX TEMPERATURE CHART | -40 | | +150 | °C |

BLOCK DIAGRAM CURRENT SINKING OR SOURCING OUTPUT

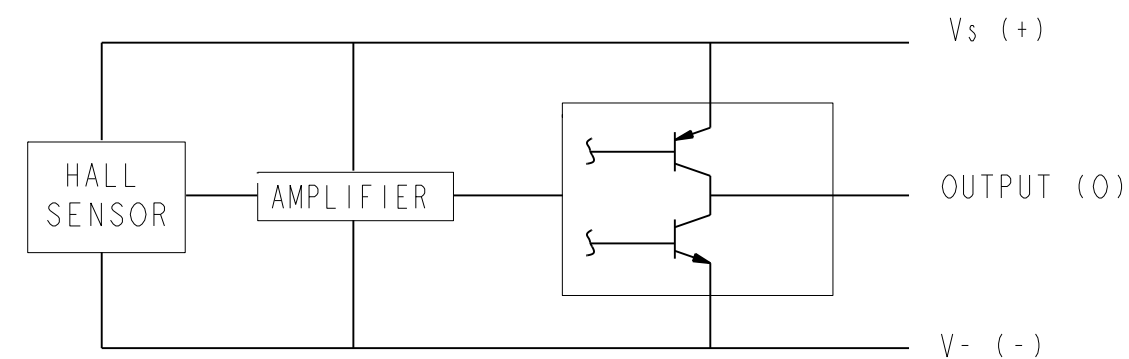

ABSOLUTE MAXIMUM CHARACTERISTICS

| CHARACTERISTIC | SYMBOL | TEST CONDITION | MIN | MAX | UNITS |
|----------------|-----------|------------------------|------|-----|-------|
| SUPPLY VOLTAGE | V_{cc} | | -0.5 | 11 | V |
| OUTPUT VOLTAGE | V_{out} | | -0.5 | 11 | V |
| OUTPUT CURRENT | I_{out} | SOURCE OR SINK | 10 | | mA |
| TEMPERATURE | T_A | OPERATING | -55 | 150 | °C |
| | T_s | STORAGE ($V_{cc}=0$) | -55 | 165 | °C |

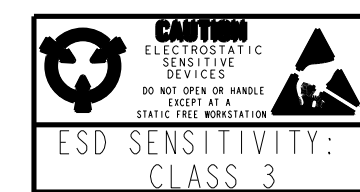
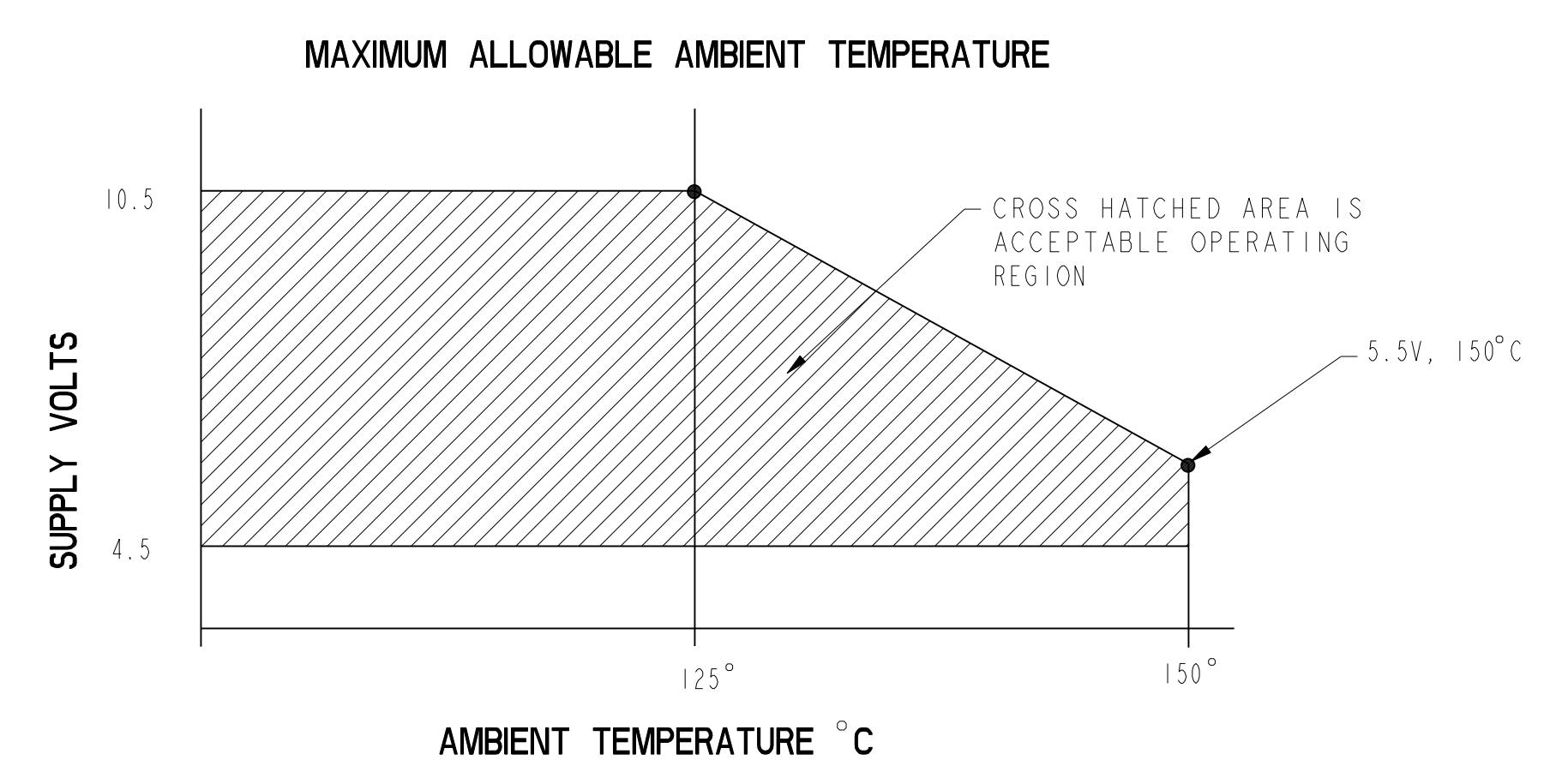
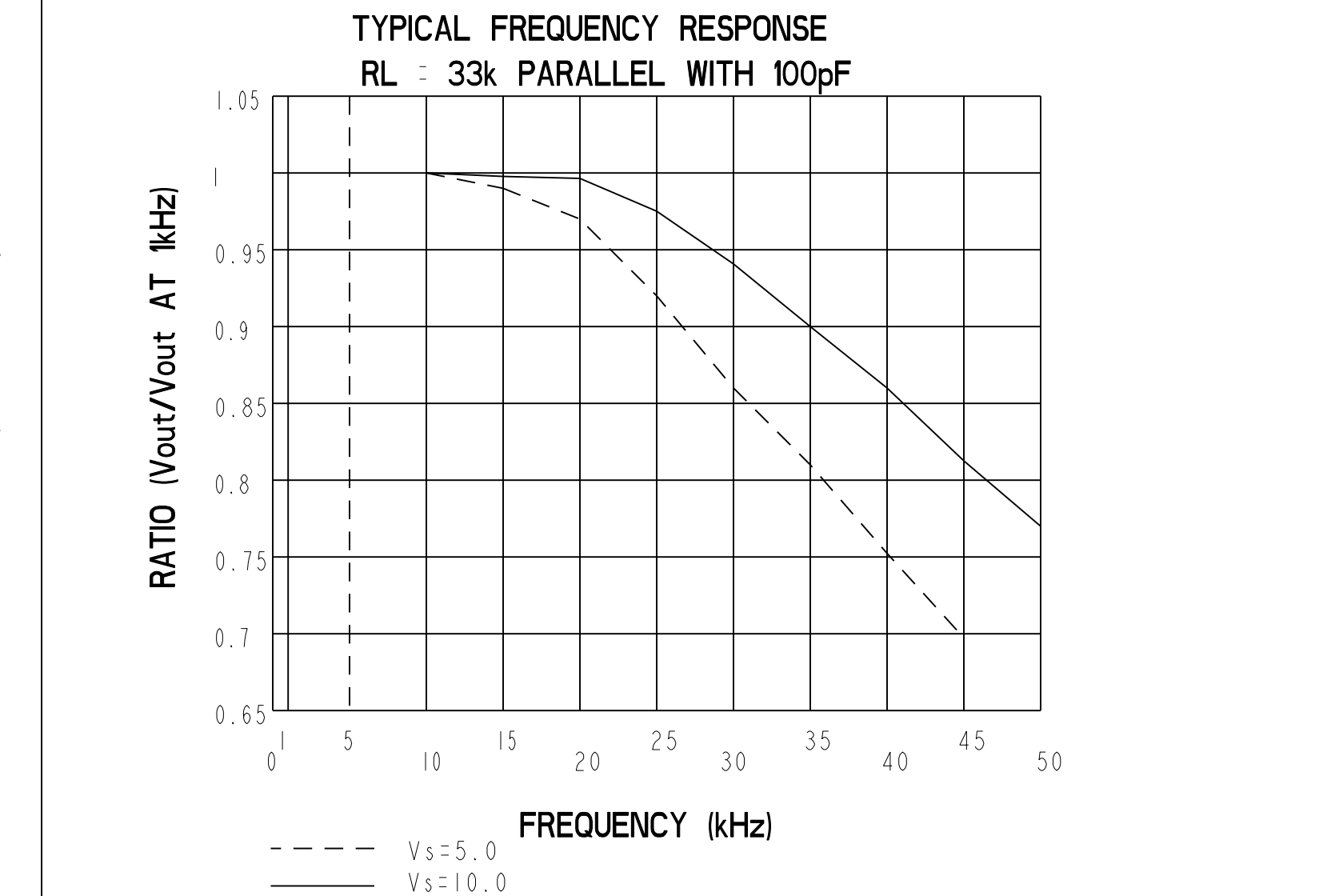
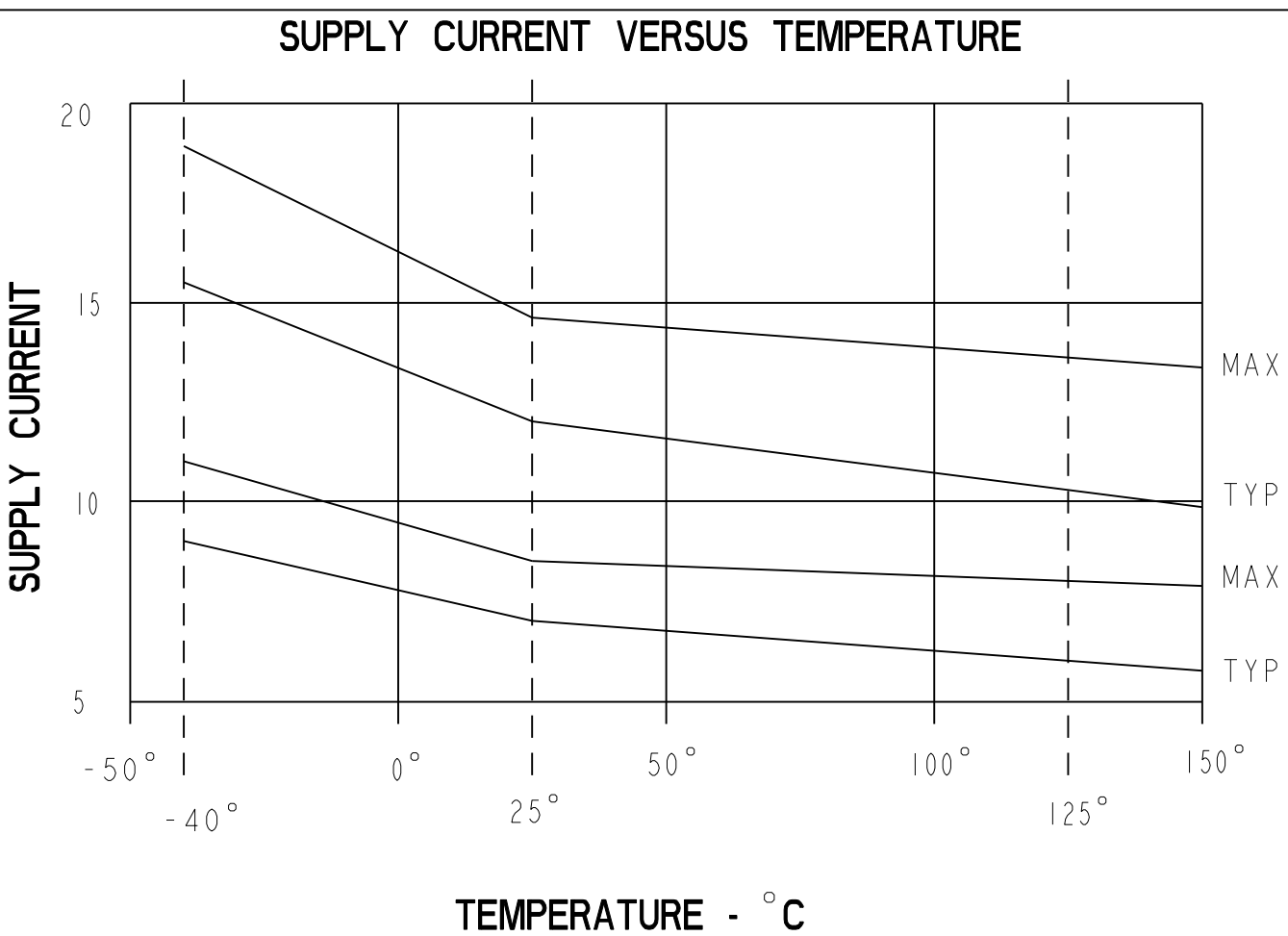
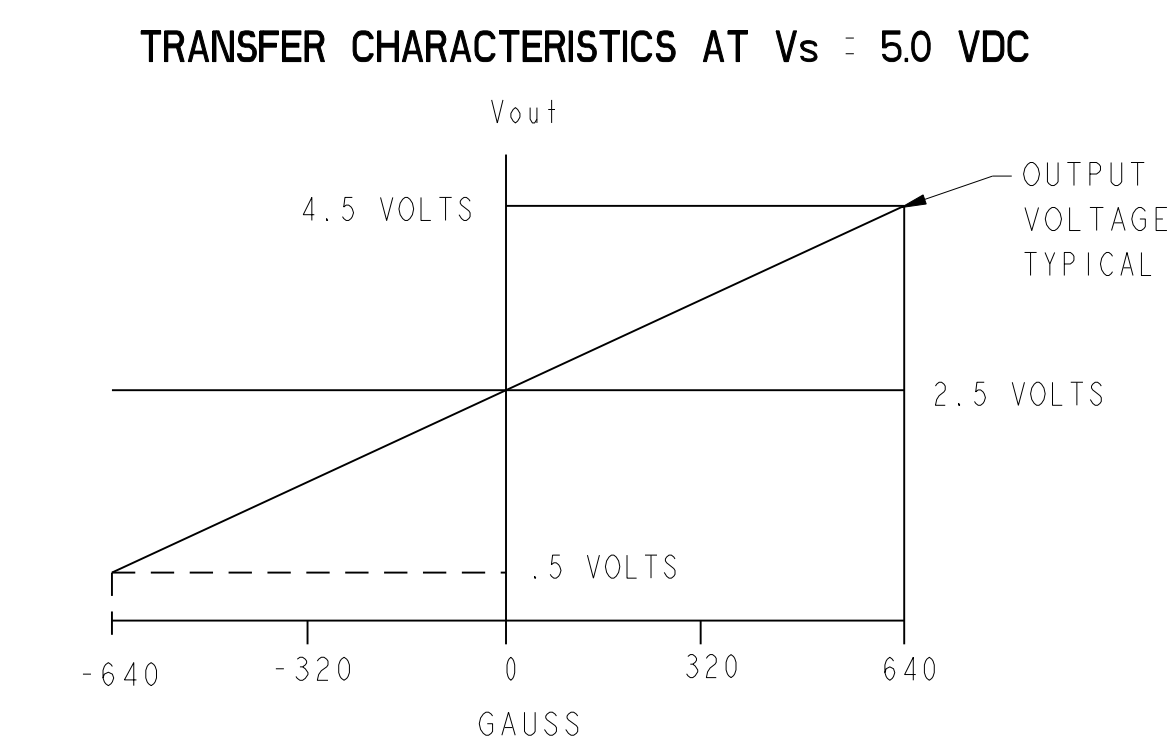
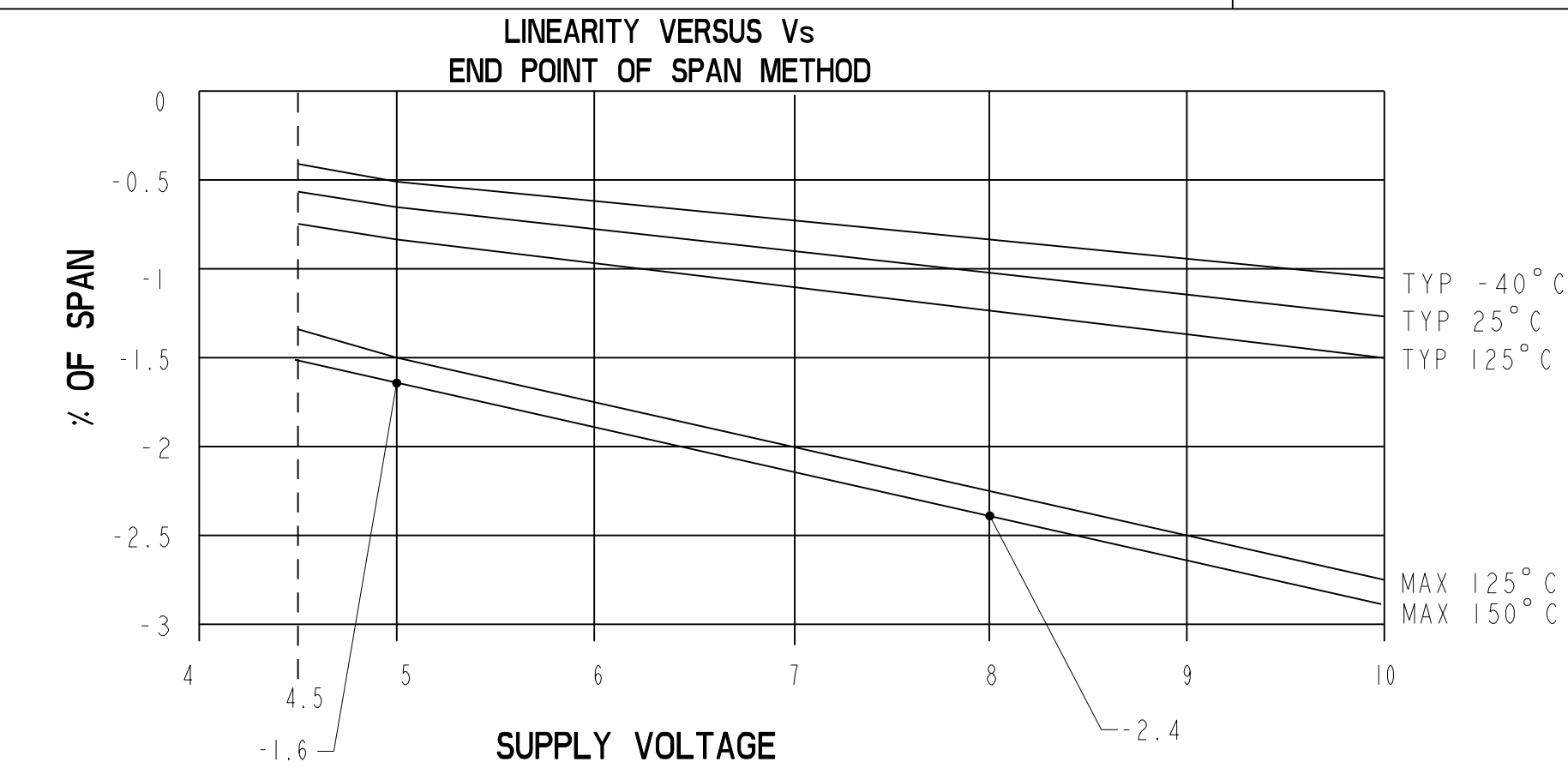
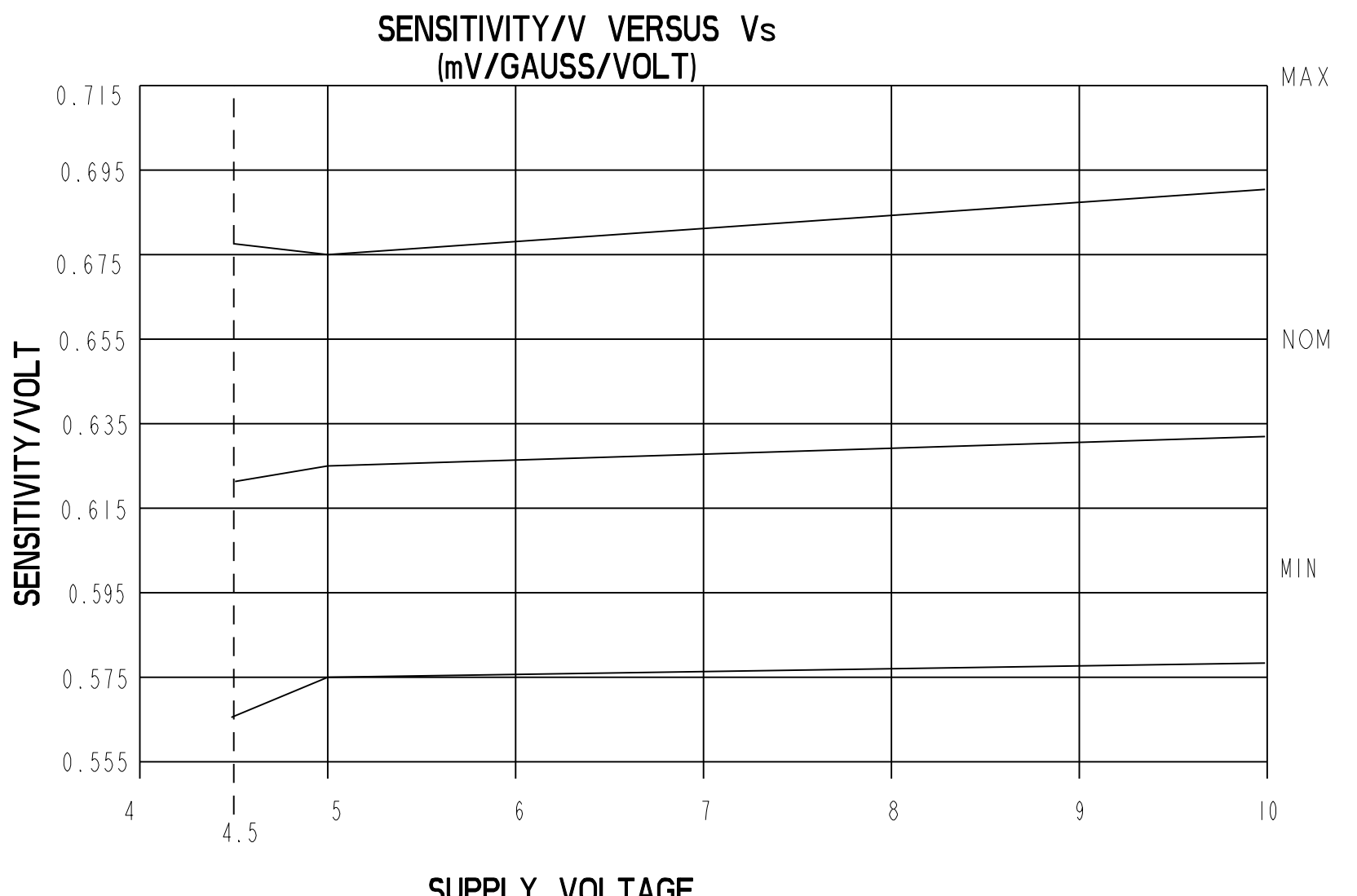
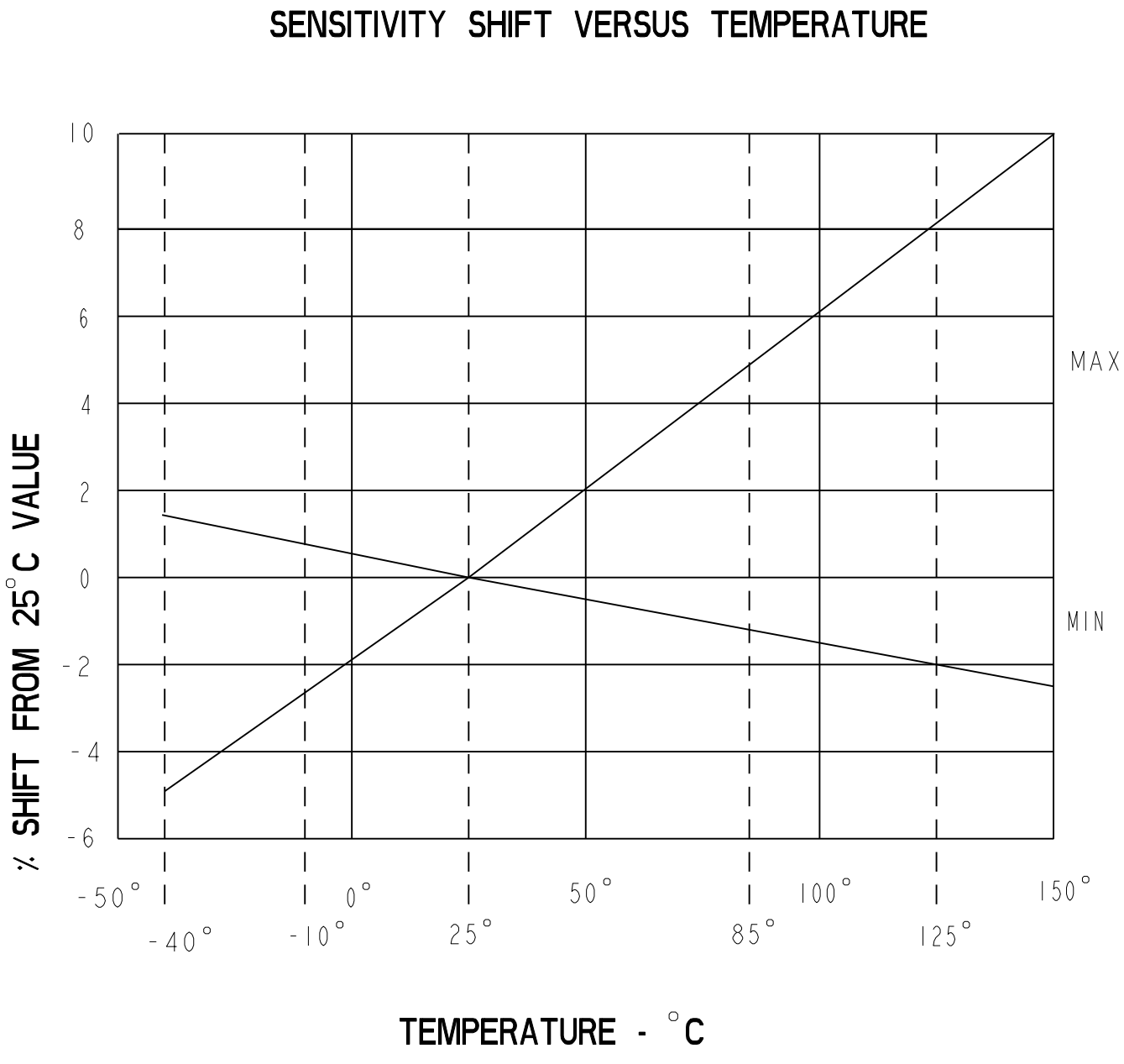
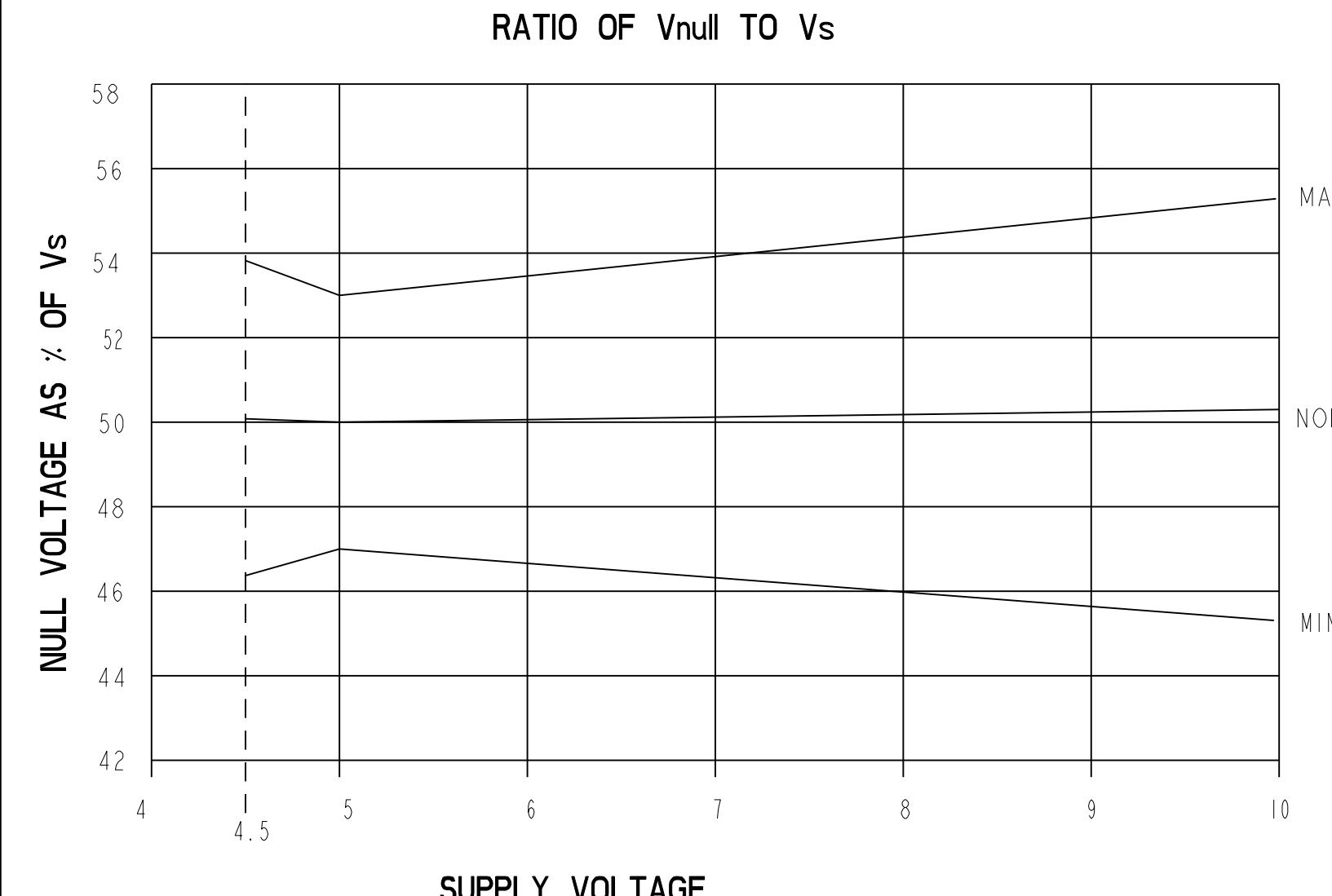
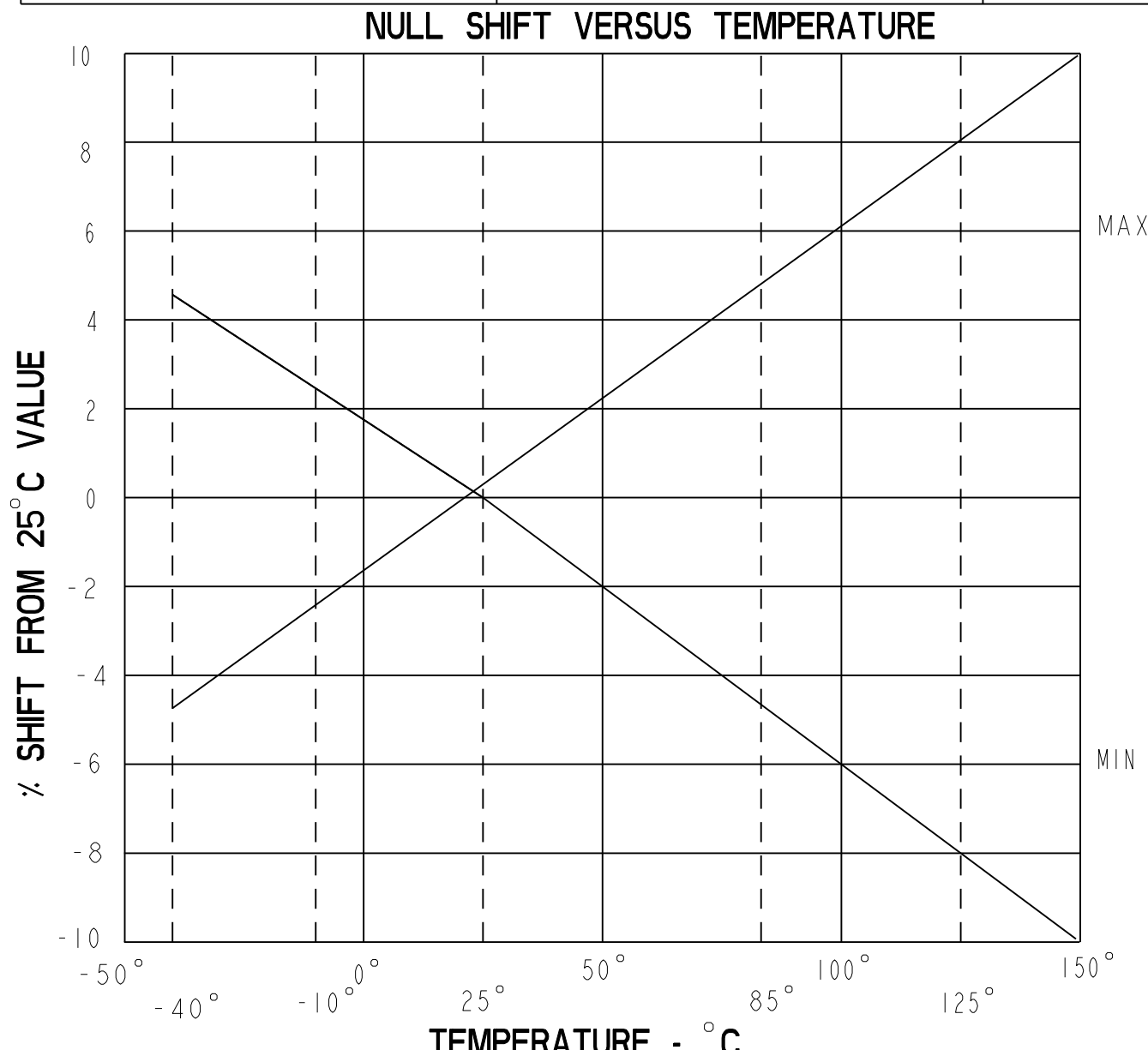

THIS DRAWING COVERS A PROPRIETARY ITEM AND IS THE PROPERTY OF MICRO SWITCH, A DIVISION OF HONEYWELL. THIS DRAWING IS NOT TO BE COPIED OR USED WITHOUT THE APPROVAL OF MICRO SWITCH.

FED. MFG. CODE 91929

MICRO SWITCH
a Honeywell Division

**MINIATURE RATIO-METRIC
LINEAR HALL EFFECT SENSOR**

SS495 SERIES CHART 1

THIRD ANGLE PROJECTION

SCALE NONE

DO NOT SCALE PRINT

UNLESS OTHERWISE SPECIFIED TOLERANCES ARE

ONE PLACE (.0) +.030

TWO PLACE (.00) +.015

THREE PLACE (.000) +.005

ANGLES +2°

WEIGHT

PTC/CAD 20
 DRAWN
 C.S. L. 15 APR 02
 CHECK
 S.A.V. 5 APR 02
 APPROVED
 14
 ISSUE
 DRAWING NUMBER
 5 OF 5
 RELEASE NO. PR-24083
 REVISIONS
 C 003535
 26 OCT 01
 MICRO SWITCH
 14400 W. BROADWAY
 CHICAGO, IL 60641-1000
 U.S.A.