









-  Magnetic Integrated Connector Modules
-  Compliant with IEEE802.3 standard including 350μH OCL with 8mA DC Bias
-  1500Vrms isolation voltage per IEEE802.3
-  Enhanced performance on EMI suppression with metal shield
-  Support 4 pairs of Category 5 UTP cable with 1000Base-T full duplex applications
-  Operating temperature 0°C to +70°C
-  Stacked design for Hub and Switch applications
-  UL 1863 listed
-  RoHS compliant versions are available



GENERAL ELECTRICAL SPECIFICATION @ 25°C

Insertion Loss (dB Max)		Return Loss ¹ (dB Min)		CMRR (dB Min)	Crosstalk ¹ (dB Min)	Hipot (Vrms)
0.1-100MHz	100-100MHz	0.5-40MHz	40-100MHz	0.1-100MHz	0.1-100MHz	
1.0	1.2	18.0	12-20Log(F/80)	32.0	33-20Log(F/50)	1500

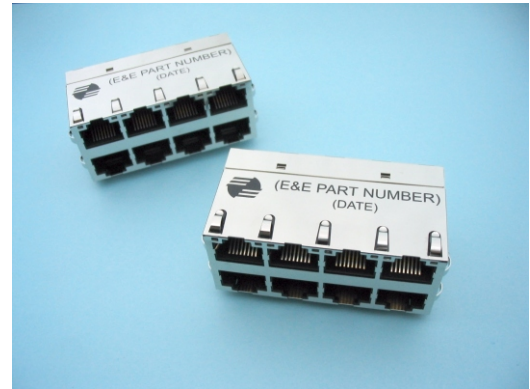
PART NUMBER TABLE

Part Number ²	RoHS Part Number	Turn Ratio (±3%) (Chip : Cable)	Configuration ³	LED ⁴ (Left / Right)	Mechanical Package	Schematic
MJ-24N2EEA0-G100	MJR24N2EEA0-G100	1CT:1CT	TC	E / E	MJ24N-06A	G100
MJ-24N2EEA0-G300	MJR24N2EEA0-G300	1CT:1	TCA	E / E	MJ24N-06A	G300
MJ-26N2EEA0-G100	MJR26N2EEA0-G100	1CT:1CT	TC	E / E	MJ26N-06A	G100
MJ-26N2EEA0-G300	MJR26N2EEA0-G300	1CT:1	TCA	E / E	MJ26N-06A	G300
MJ-28N2EEA0-G100	MJR28N2EEA0-G100	1CT:1CT	TC	E / E	MJ28N-06A	G100
MJ-28N2EEA0-G300	MJR28N2EEA0-G300	1CT:1	TCA	E / E	MJ28N-06A	G300

Notes:

1. "F" represents the test frequency specified in MHz.
2. For different electrical and mechanical specifications, please contact E&E Magnetic Products Limited.
3. Core location are counted from PCB (Chip) side to Cable (Media) side, where:
"T" = Isolation transformer ; "C" = Common-mode choke ; "A" = Auto-transformer
4. LEDs (Left / Right) : "E" = Orange & Green bi-color (3 terminals type). For different LED color requirements, please contact E&E Magnetic Products Limited.
5. Panel tabs are optional.
6. All parts shown in this datasheet have gold plating thickness of 10 micro-inch (min.) over contact area. Advance options including 30 micro-inch (min.) and 50 micro-inch (min.) are also available.

MATERIALS

Housing	Consist of thermoset & thermoplastic materials, all of them are UL 94-V0 rated.
Contact Pins ⁶	Phosphor bronze, plated with nickel under-plating and hard gold over contact area.
PCB Pins	Copper wire which meets solderability requirements per MIL-STD-202, method 208.

MECHANICAL DIMENSIONS

MJ24N-06A

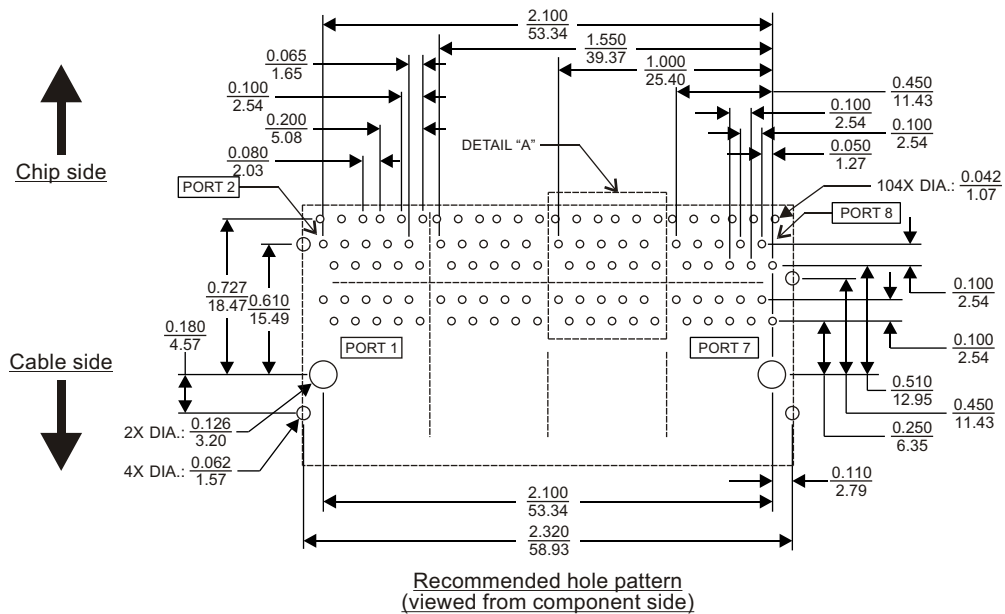
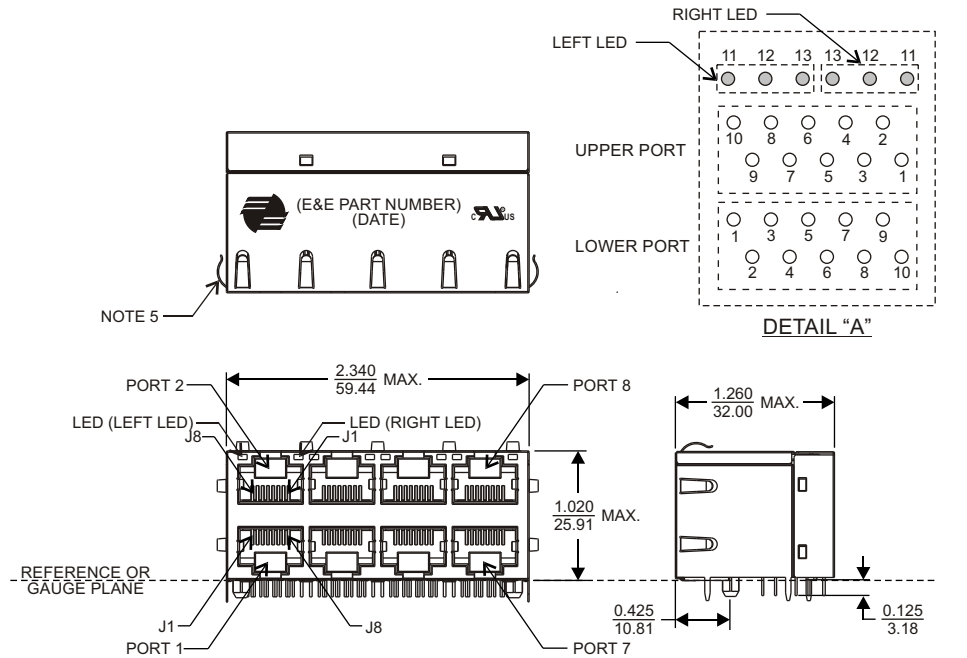

All dimensions are specified in $\frac{\text{inch}}{\text{mm}}$ with higher precedence in inch.

Unless otherwise specified, all tolerances are $\pm \frac{0.010}{0.25}$.

MECHANICAL DIMENSIONS

MJ26N-06A

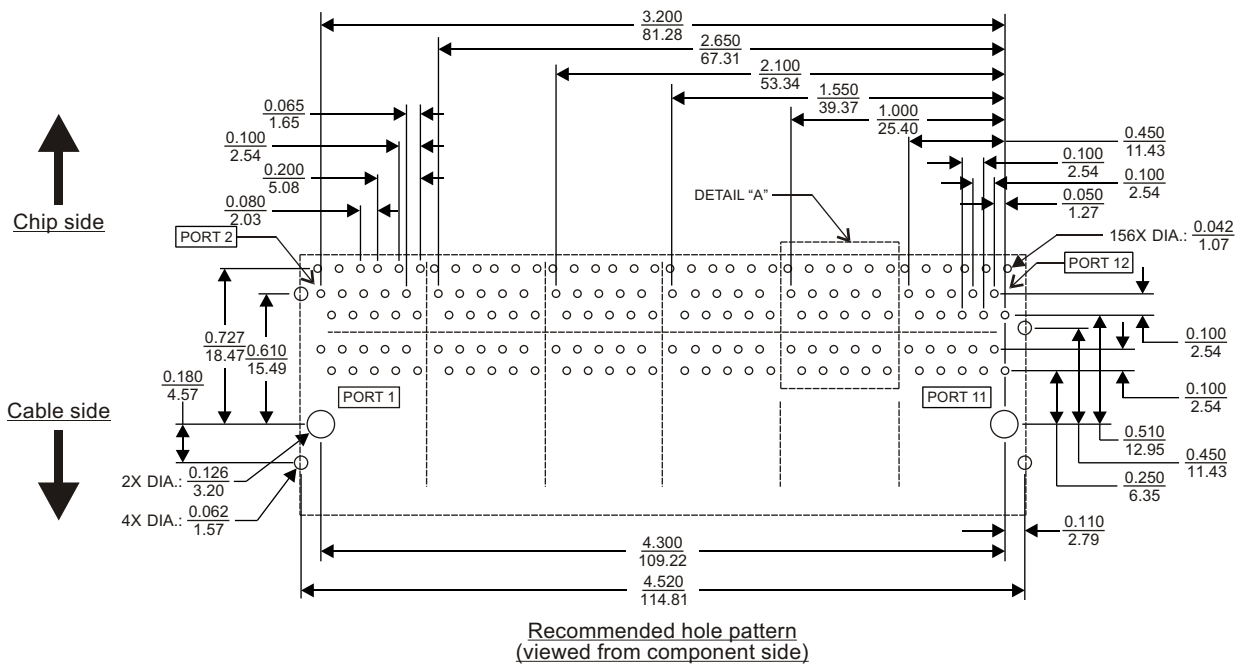
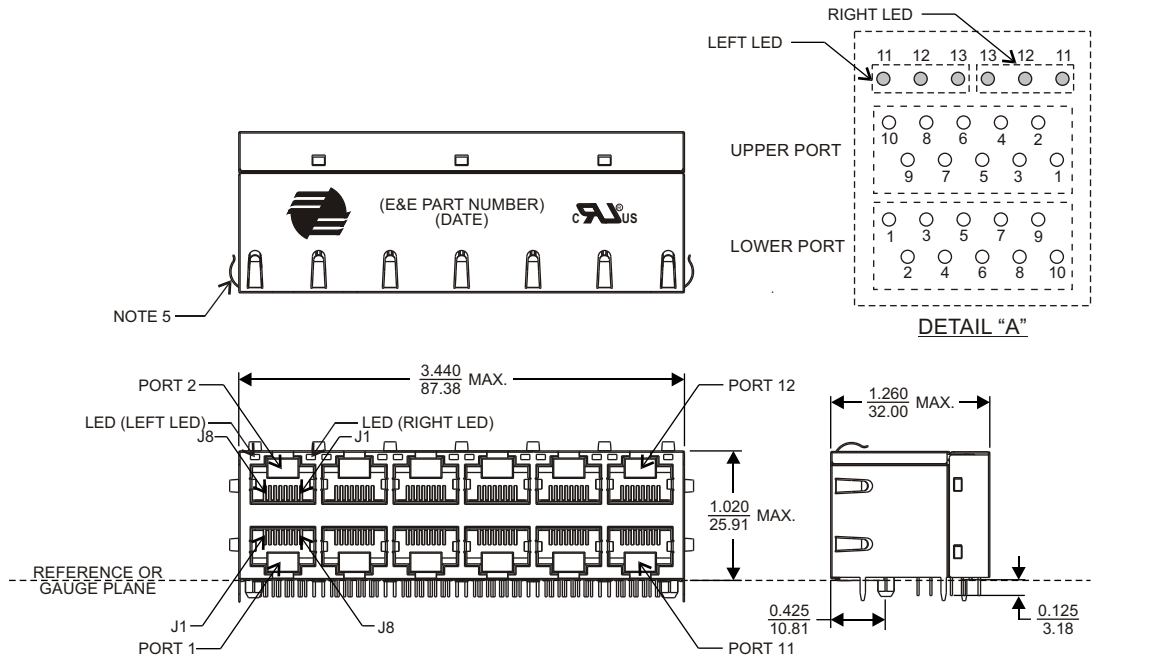

All dimensions are specified in $\frac{\text{inch}}{\text{mm}}$ with higher precedence in inch.

Unless otherwise specified, all tolerances are $\pm \frac{0.010}{0.25}$.

MECHANICAL DIMENSIONS

MJ28N-06A

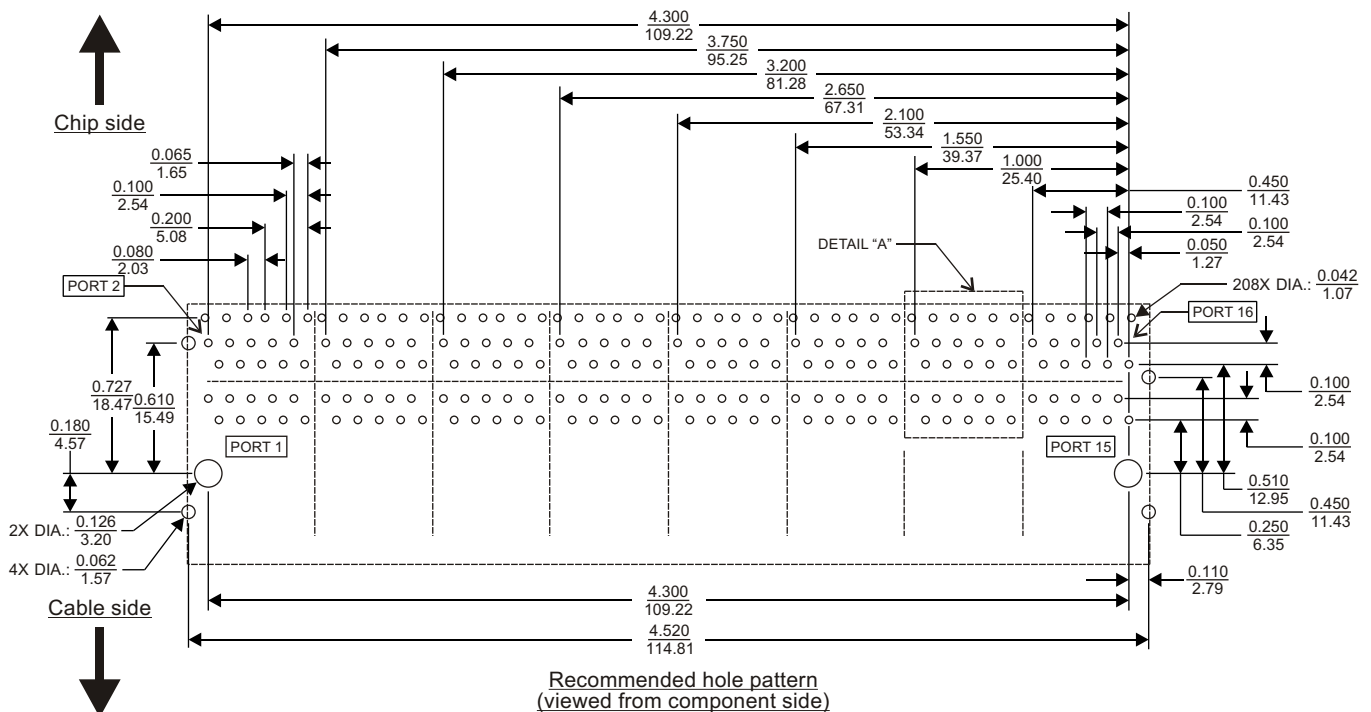
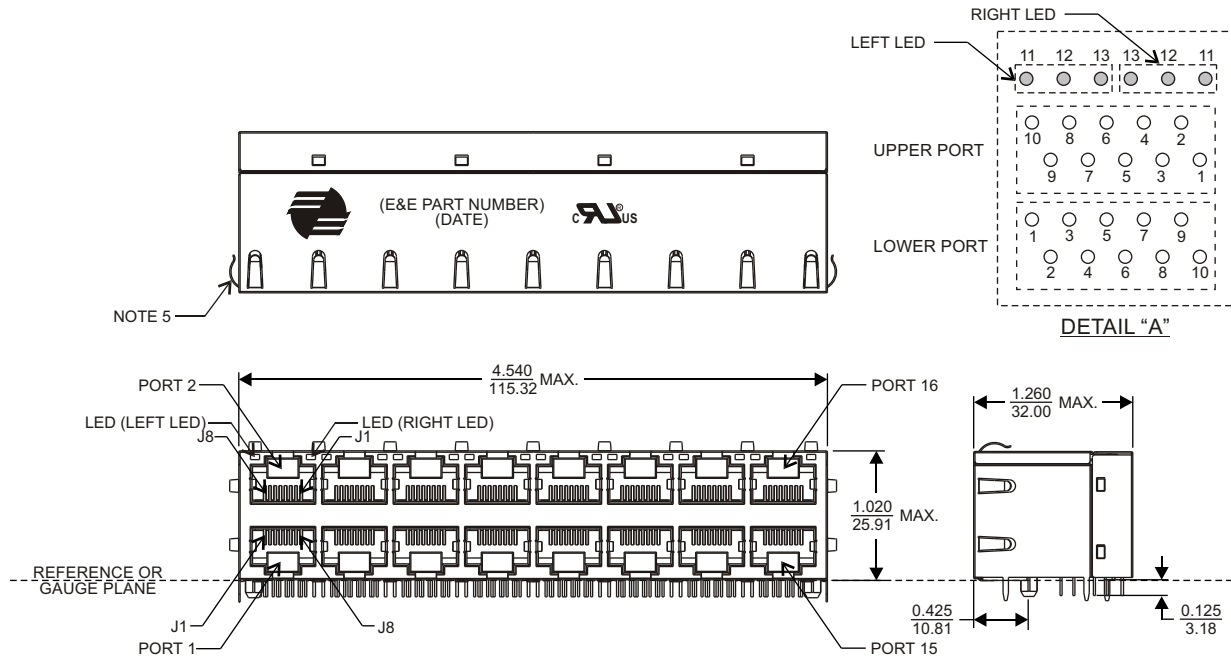

All dimensions are specified in $\frac{\text{inch}}{\text{mm}}$ with higher precedence in inch.

Unless otherwise specified, all tolerances are $\pm \frac{0.010}{0.25}$.



SCHEMATICS (EACH PORT)

G100

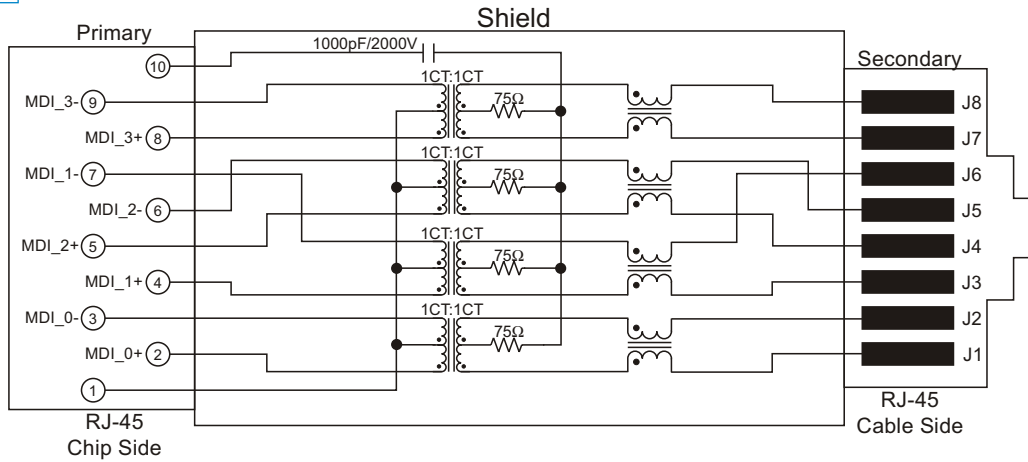

G300

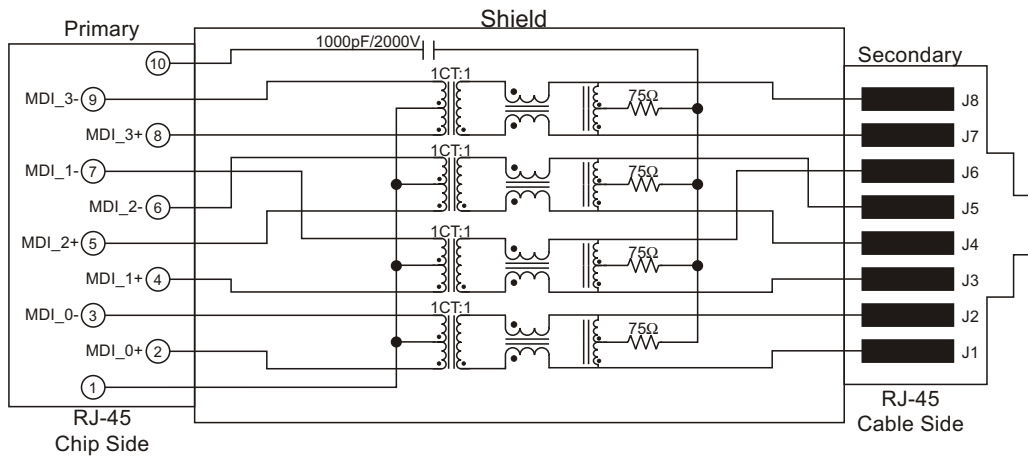



LEDs COLOR AND POLARITY

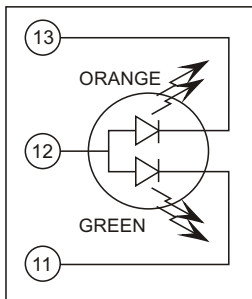

COLOR	POLARITY		COLOR	POLARITY	
	PIN 12	PIN 11		PIN 12	PIN 13
GREEN	+	-	ORANGE	+	-

LED SPECIFICATION @25°C, FORWARD CURRENT = 20mA

Standard Color	Typical Wavelength (nm)	Forward Voltage (volt)	
		Typical	Maximum
Green	565	2.2	2.5
Orange	607	2.05	2.5

FOR MORE INFORMATION, PLEASE CONTACT

HEADQUARTER
2/F Block A, Merit Industrial Centre,
94 Tokwawan Road, Kowloon,
Hong Kong
Tel: (852) 2765 3888
Fax: (852) 2954 3304
Email: eempl@eleceltek.com
Website: <http://www.eleceltek.com>

Information herein is for reference only and subject to change without notice. It does not constitute any representation, warranty or commitment of the company in respect of the products in any aspect. All logos, brands and product names mentioned herein are trademarks or registered trademarks of their respective owners. The company does not assume any liability arising out of the application or use of any product or circuit described herein. Copyrights 2006, E & E Magnetic Products Limited.