

FAN2013B — 2A Low-Voltage, Current-Mode Synchronous PWM Buck Regulator

Features

- 95% Efficiency, Synchronous Operation
- Adjustable Output Voltage from 0.8V to 2.5V
- 4.5V to 5.5V Input Voltage Range
- Up to 2A Output Current
- Fixed-Frequency 1.2 MHz PWM Operation
- Soft-Start Function
- Excellent Load Transient Response
- Power-Good Flag
- Over-Voltage, Under-Voltage Lockout, Short-Circuit, and Thermal Shutdown Protections
- 3x3mm 6-Lead MLP Package

Applications

- Hard Disk Drive
- Set-Top Box
- Point-of-Load Power
- Notebook Computer
- Communications Equipment

Description

The FAN2013B is a high-efficiency, low-noise, synchronous Pulse Width Modulated (PWM) current-mode DC-DC converter designed for low-voltage applications. It provides up to 2A continuous-load current from the 4.5V to 5.5V input. The output voltage is adjustable over a wide range by means of an external voltage divider.

The FAN2013B is enabled when the input voltage on the V_{IN} pin exceeds the UVLO threshold.

A current-mode control loop with a fast transient response ensures excellent line and load regulation. The fixed 1.2MHz switching frequency enables designers to choose a small, inexpensive external inductor and capacitor. Filtering can be accomplished with small components, reducing space and cost.

Protection features include input under-voltage lockout, short-circuit protection, and thermal shutdown. Soft-start limits inrush current during start-up conditions.

The device is available in a 3x3mm 6-lead MLP.

Typical Application

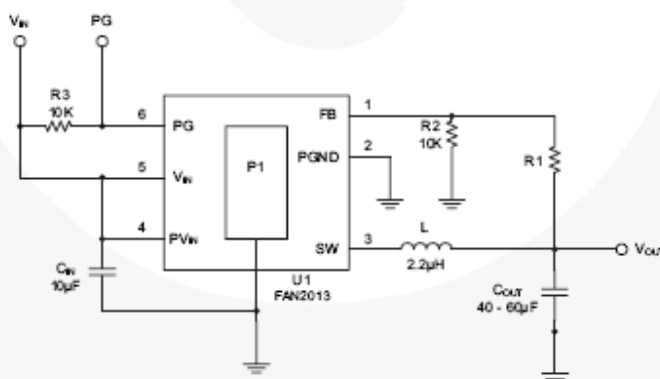

Figure 1. Typical Application

Ordering Information

Part Number	Output Voltage	Package	Packing Method
FAN2013BMPX	0.8V to 2.5V	3x3mm 6-Lead Molded Leadless Package (MLP)	Tape and Reel

Pin Assignments

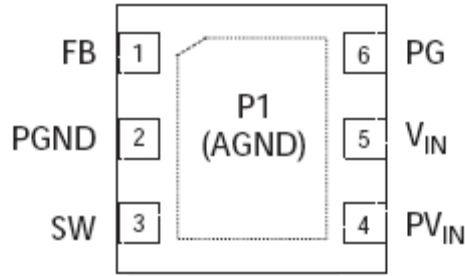

Figure 2. Pin Assignments (Top View)

Pin Definitions

Pin #	Name	Description
P1	AGND	Analog Ground. P1 must be soldered to the PCB ground.
1	FB	Feedback Input. Adjustable voltage option; connect this pin to the resistor divider.
2	PGND	Power Ground. This pin is connected to the internal MOSFET switches. This pin must be externally connected to AGND.
3	SW	Switching Node. This pin is connected to the internal MOSFET switches.
4	PVIN	Supply Voltage Input. This pin is connected to the internal MOSFET switches.
5	VIN	Supply Voltage Input.
6	PG	Open Drain Power Good.

Absolute Maximum Ratings

Stresses exceeding the absolute maximum ratings may damage the device. The device may not function or be operable above the recommended operating conditions and stressing the parts to these levels is not recommended. In addition, extended exposure to stresses above the recommended operating conditions may affect device reliability. The absolute maximum ratings are stress ratings only.

Symbol	Parameter	Min.	Max.	Unit
V_{IN}	Supply Voltage	-0.3	7.0	V
	Input Voltage on PVIN and Any Other Pin	-0.3	V_{IN}	V
θ_{JC}	Thermal Resistance, Junction-to-Tab ⁽¹⁾		8	°C/W
T_L	Lead Soldering Temperature (10 Seconds)		+260	°C
T_{STG}	Storage Temperature	-65	+150	°C
T_J	Junction Temperature	-40	+150	°C
ESD	Electrostatic Discharge Protection Level ⁽²⁾	Human Body Model, JESD22-A114	3.5	kV
		Charged Device Model, JESD22-C101	2.0	

Notes:

- Junction-to-ambient thermal resistance, θ_{JA} , is a strong function of PCB material, board thickness, thickness and number of copper planes, number of via used, diameter of via used, available copper surface, and attached heat sink characteristics.
- Using Mil Std. 883E, method 3015.7 (Human Body Model) and EIA/JESD22C101-A (Charged Device Model).

Recommended Operating Conditions

The Recommended Operating Conditions table defines the conditions for actual device operation. Recommended operating conditions are specified to ensure optimal performance to the datasheet specifications. Fairchild does not recommend exceeding them or designing to Absolute Maximum Ratings.

Symbols	Parameter	Min.	Typ.	Max.	Unit
V_{IN}	Supply Voltage Range	4.5		5.5	V
V_{OUT}	Output Voltage Range, Adjustable Version	0.8		2.5	V
I_{OUT}	Output Current			2.0	A
L	Inductor ⁽³⁾		2.2		μH
C_{IN}	Input Capacitor ⁽³⁾	10	20		μF
C_{OUT}	Output Capacitor ⁽³⁾	20	40		μF
T_A	Operating Ambient Temperature Range	-40		+85	°C

Note:

- Refer to the Applications section for details.

Electrical Characteristics

$V_{IN} = 4.5V$ to $5.5V$, $V_{OUT} = 1.2V$, $I_{OUT} = 200mA$, $C_{IN} = 10\mu F$, $C_{OUT} = 40\mu F$, $L = 2.2\mu H$, $T_A = -40^\circ C$ to $+85^\circ C$, unless otherwise noted. Typical values are at $T_A = 25^\circ C$.

Symbol	Parameter	Conditions	Min.	Typ.	Max.	Units
V_{IN}	Input Voltage		4.5		5.5	V
I_Q	Quiescent Current	$I_{OUT} = 0mA$		10	16	mA
V_{UVLO}	UVLO Threshold	V_{IN} Rising	3.4	3.7	4.0	V
		Hysteresis		150		mV
R_{ON_PMOS}	PMOS On Resistance	$V_{IN} = V_{GS} = 5V$		90		m Ω
R_{ON_NMOS}	NMOS On Resistance	$V_{IN} = V_{GS} = 5V$		90		m Ω
I_{LIMIT}	P-Channel Current Limit	$4.5V < V_{IN} < 5.5V$	2.8	3.5	4.2	A
	Over-Temperature Protection	Rising Temperature		150		$^\circ C$
		Hysteresis		20		$^\circ C$
f_{SW}	Switching Frequency		1000	1200	1400	kHz
R_{LINE}	Line Regulation	$V_{IN} = 4.5$ to $5.5V$, $I_{OUT} = 100mA$		0.16		%/V
R_{LOAD}	Load Regulation	$0mA \leq I_{OUT} \leq 2000mA$		0.3	0.6	%
V_{OUT}	Output Voltage During Load Transition ⁽⁴⁾	I_{OUT} from 1500mA to 100mA, $C_{OUT} = 60\mu F$			5	%
		I_{OUT} from 100mA to 1500mA, $C_{OUT} = 60\mu F$	-5			%
I_{LEAK}	Reverse Leakage Current into Pin SW	$V_{IN} = \text{Open}$, $EN = GND$, $V_{SW} = 5.5V$		0.1	1.0	μA
V_{REF}	Reference Voltage			0.8		V
V_{OUT}	Output Voltage Accuracy	$V_{IN} = 4.5$ to $5.5V$, $0mA \leq I_{OUT} \leq 2000mA$, $T_A = 0^\circ C$ to $+85^\circ C$	-2		2	%
		$V_{IN} = 4.5$ to $5.5V$, $0mA \leq I_{OUT} \leq 2000mA$, $T_A = -40^\circ C$ to $+85^\circ C$	-3		3	%
V_{PG}	Power Good Output Threshold and Hysteresis	FB Voltage Rising		$0.9 \times V_{OUT}$		V
		Hysteresis		1		%
t_{PG}	Power Good Output Delay			100		μs
V_{PG_LOW}	Power Good Voltage Low	$I_{sink} = 6mA$, Open-Drain Output			0.4	V
V_{OVP}	Over-Voltage Protection Threshold and Hysteresis	FB Voltage Rising		$1.07 \times V_{OUT}$		V
		Hysteresis		2		%

Note:

4. Please refer to the load transient response test waveform shown in Figure 3.

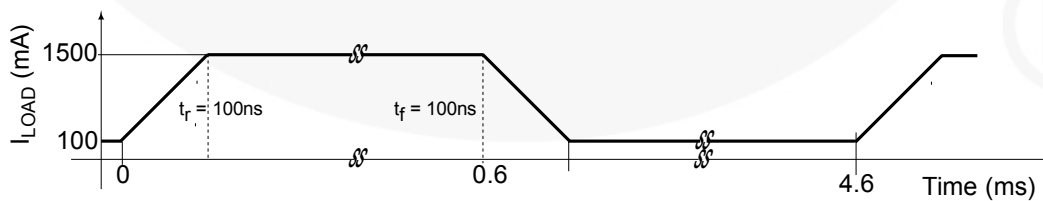

Figure 3. Load Transient Response Test Waveform

Typical Performance Characteristics

$T_A = 25^\circ\text{C}$, $C_{IN} = 10\mu\text{F}$, $C_{OUT} = 40\mu\text{F}$, $L = 2.2\mu\text{H}$, $V_{IN} = 5\text{V}$, $V_{OUT} = 1.2\text{V}$, unless otherwise noted.



Figure 4. Startup with 100mA Resistive Load

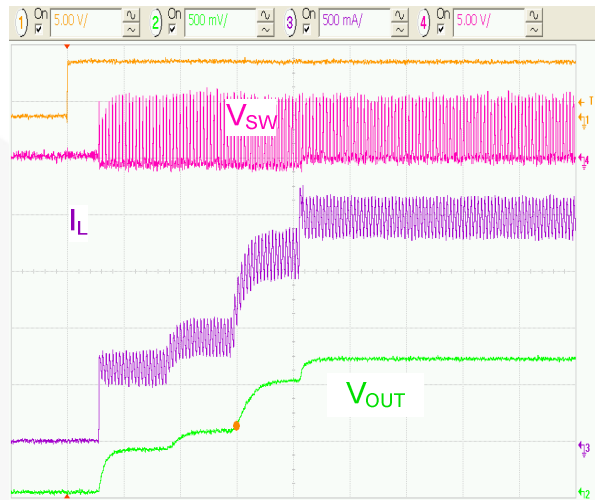

Figure 5. Startup with 2A Resistive Load

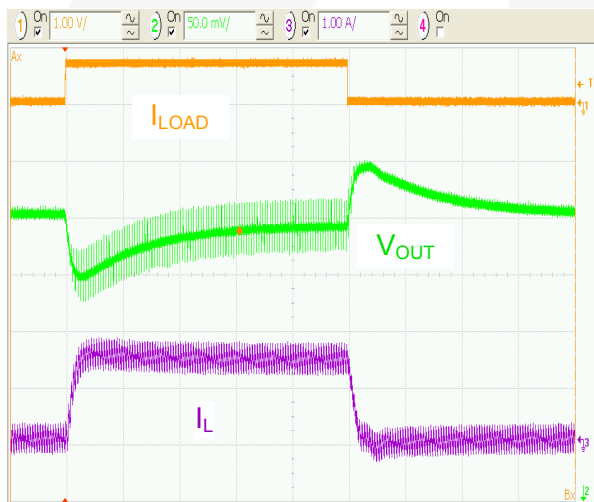

Figure 6. Load Transient Response, 1.2V_{OUT} (100mA to 1500mA, 20μs/div)

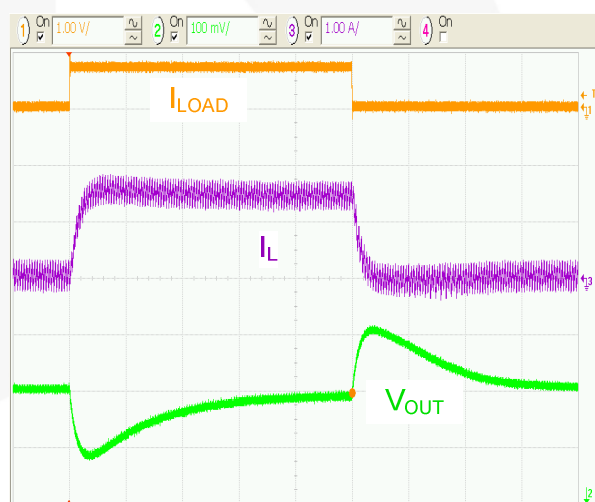

Figure 7. Load Transient Response, 3.3V_{OUT} (100mA to 1500mA, 20μs/div)

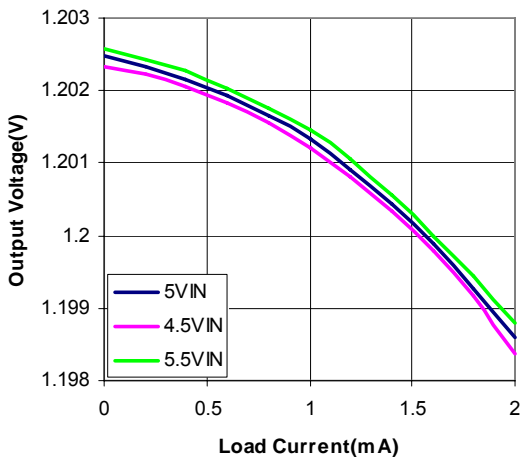

Figure 8. Output Voltage Regulation

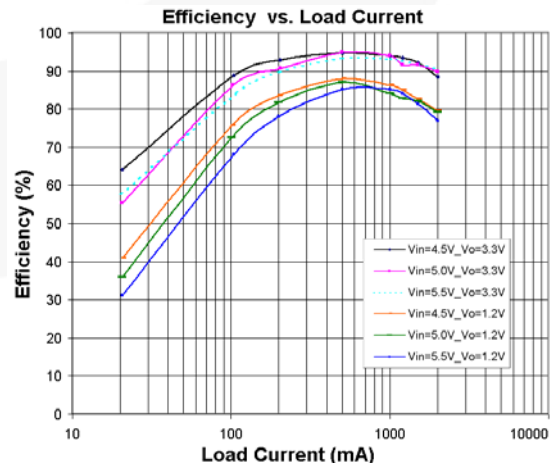

Figure 9. Power Efficiency

Block Diagram

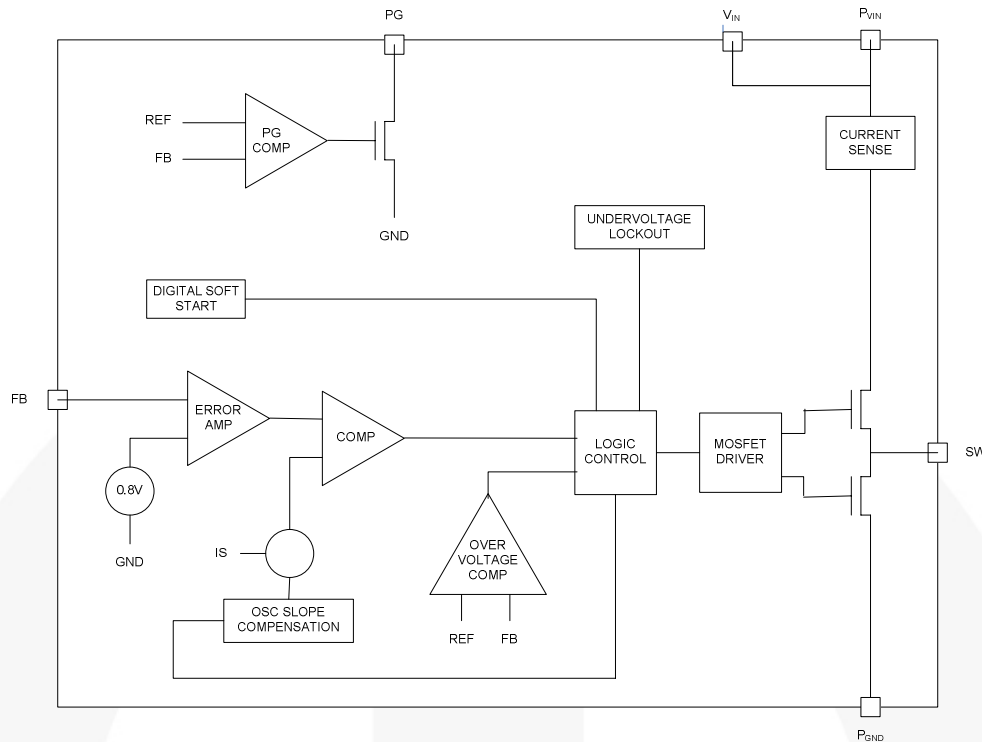

Figure 10. Block Diagram

Detailed Operation Description

The FAN2013B is a step-down pulse-width modulated (PWM) current mode converter with a fixed switching frequency of 1.2MHz. At the rising edge of each clock cycle, the P-channel transistor is turned on until the PWM comparator trips or the current limit is reached. During the ON time, the inductor current ramps up and is monitored by the internal current-mode control loop. After a minimum dead time, the N-channel transistor is turned ON and the inductor current ramps down. As the clock cycle is completed, the N-channel switch is turned OFF and the next clock cycle starts. The duty cycle is given by the ratio of output voltage and input voltage. The converter runs at minimum duty cycle when the output voltage is at minimum and input voltage is at maximum. The duty cycle increases proportionally as the input voltage approaches the output voltage.

UVLO and Soft-Start

The internal voltage reference, V_{REF} , and the IC remain reset until V_{IN} reaches the UVLO threshold.

The FAN2013B has an internal soft-start circuit that limits the inrush current during start-up. This prevents possible voltage drops of the input voltage and eliminates the output voltage overshoot. The soft-start is implemented as a digital circuit, increasing the switch current in four steps to the P-channel current limit. Typical start-up time for a 40 μ F output capacitor with a load current of 2.0A is 800 μ s.

Output Over-Voltage Protection

When output voltage, V_{OUT} , reaches approximately 7% above the nominal value, the device turns OFF the P-channel switch and turns ON part of the N-channel transistor with a built-in current limit of about 400mA. When V_{OUT} reaches the hysteresis of about 2%, the device starts switching normally in closed loop. If output voltage is pulled up by an external voltage source with a current limit higher than typical 400mA, the output voltage stays up at the external voltage source level.

The over-voltage protection is designed to limit the output voltage excursion in case of a transient response from full load to a minimum load.

Output Short-Circuit Protection

The switch peak current is limited cycle by cycle to a typical value of 3.5A. In the event of an output voltage short circuit, the device operates with a frequency of 400kHz and minimum duty cycle, making the average typical input current 0.45A.

Thermal Shutdown

When the die temperature exceeds 150°C, a reset occurs and remains in effect until the die cools to 130°C, when the circuit is allowed to re-initiate a soft-start cycle..

Applications Information

Setting the Output Voltage

The internal voltage reference is 0.8V. The output is divided down by a voltage divider, R1 and R2 to the FB pin. The output voltage is:

$$V_{OUT} = V_{REF} \left(1 + \frac{R_1}{R_2} \right) \quad (2)$$

According to this equation, assuming desired output voltage of 1.2V, and given R2 = 10KΩ as the recommended resistance for any output voltage setting, the calculated value of R1 is 5KΩ. Maximum V_{OUT} = 2.5V.

Inductor Selection

The inductor parameters directly related to device performance are saturation current and DC resistance. The FAN2013B operates with a typical inductor value of 2.2μH. The lower the DC resistance, the higher the efficiency. For saturation current, the inductor should be rated higher than the maximum load current, plus half of the inductor ripple current, calculated by:

$$\Delta I_L = V_{OUT} \times \frac{1 - (V_{OUT}/V_{IN})}{L \times f} \quad (3)$$

where:

ΔI_L = Inductor Ripple Current
 f = Switching Frequency
 L = Inductor Value

Recommended inductors are listed in Table 1.

Table 1. Recommended Inductors

Inductor Value	Vendor	Part Number
2.2μH	Coiltronics	SD25 2R2
2.2μH	Murata	LQH66SN2R2M03L

Capacitor Selection

For best performance, a low-ESR input capacitor is required. A ceramic capacitor of at least 10μF, placed as close to the V_{IN} and AGND pins as possible is recommended.

The output capacitor determines the output ripple and the transient response. A minimum of 20μF output capacitor is required for the FAN2013B to operate in stable conditions.

Table 2. Recommended Capacitors

Capacitor Value	Vendor	Part Number
10μF	Taiyo Yuden	JMK212BJ106MG
		JMK316BJ106KL
	TDK	C2012X5ROJ106K
		C3216X5ROJ106M
	Murata	GRM32ER61C106K

PCB Layout Recommendations

The inherently high peak currents and switching frequency of power supplies require a careful PCB layout design. For best results, use wide traces for high-current paths and place the input capacitor, the inductor, and the output capacitor as close as possible to the integrated circuit terminals. To minimize voltage stress to the device resulting from ever-present switching spikes, use an input bypass capacitor with low ESR. Note that the peak amplitude of the switching spikes depends upon the load current; the higher the load current, the higher the switching spikes.

The resistor divider that sets the output voltage should be routed away from the inductor to avoid RF coupling. The ground plane at the bottom side of the PCB acts as an electromagnetic shield to reduce EMI. The recommended PCB layout is shown below in Figure 11.

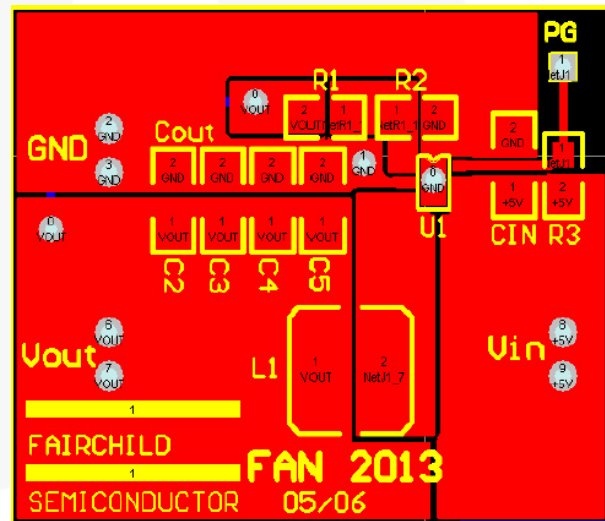
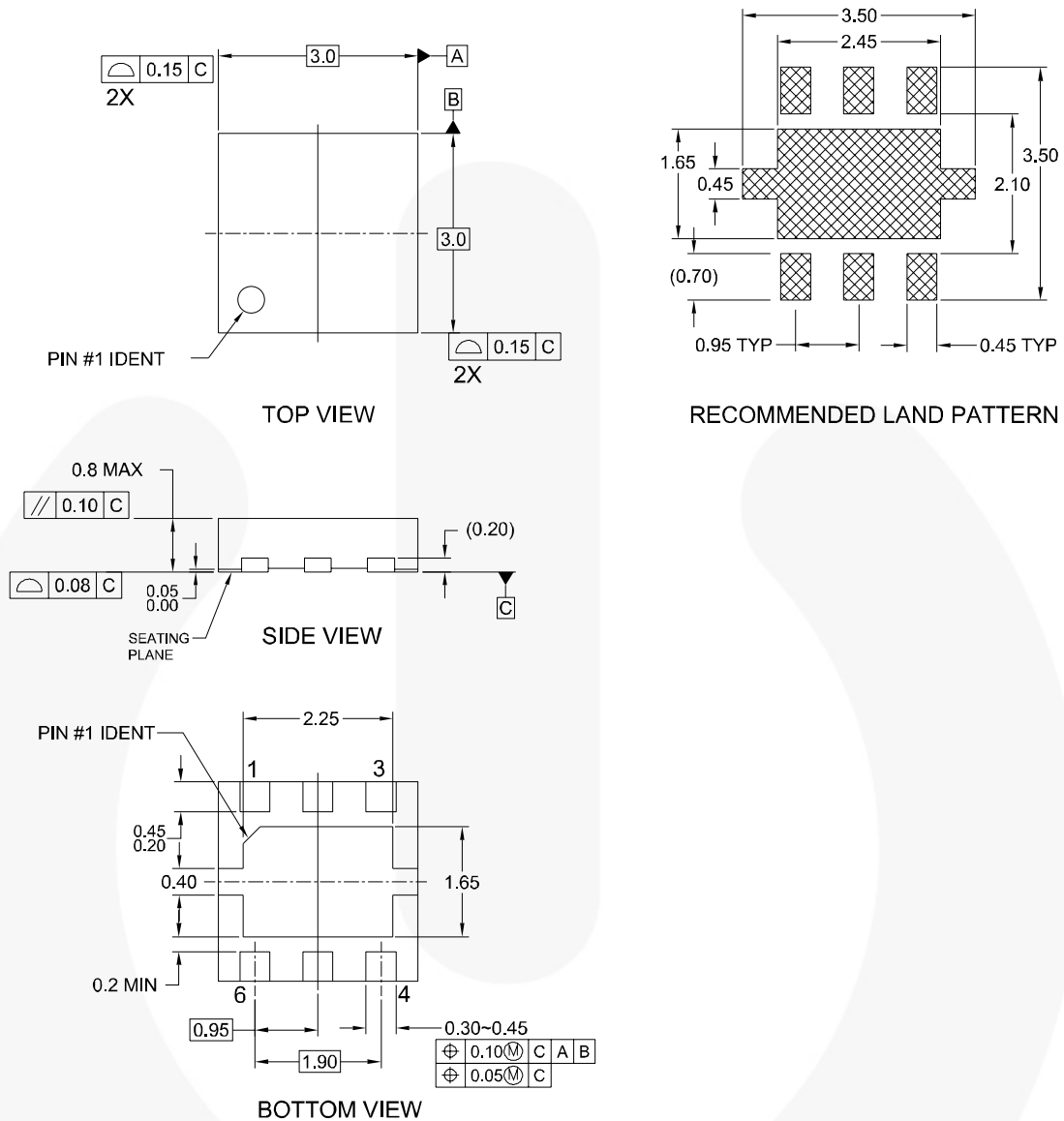

Figure 11. Recommended PCB Layout

Physical Dimensions



NOTES:

- A. CONFORMS TO JEDEC REGISTRATION MO-229, VARIATION WEEA, DATED 11/2001 EXCEPT FOR DAP EXTENSION TABS
- B. DIMENSIONS ARE IN MILLIMETERS.
- C. DIMENSIONS AND TOLERANCES PER ASME Y14.5M, 1994

MLP06FrevA

Figure 12. 3x3mm 6-Lead Molded Leadless Package (MLP)





Package drawings are provided as a service to customers considering Fairchild components. Drawings may change in any manner without notice. Please note the revision and/or date on the drawing and contact a Fairchild Semiconductor representative to verify or obtain the most recent revision. Package specifications do not expand the terms of Fairchild's worldwide terms and conditions, specifically the warranty therein, which covers Fairchild products.

Always visit Fairchild Semiconductor's online packaging area for the most recent package drawings:
<http://www.fairchildsemi.com/packaging/>



TRADEMARKS

The following includes registered and unregistered trademarks and service marks, owned by Fairchild Semiconductor and/or its global subsidiaries, and is not intended to be an exhaustive list of all such trademarks.

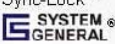
- | | | | |
|--|--|---|---|
| AccuPower™ | F-PFS™ | Power-SPM™ | The Power Franchise® |
| Auto-SPM™ | FRFET® | PowerTrench® | The Right Technology for Your Success™ |
| AX-CAP™* | Global Power Resource™ | PowerXS™ | the Power Franchise |
| Build it Now™ | Green FPST™ | Programmable Active Droop™ | TinyBoost™ |
| CorePLUS™ | Green FPST™ e-Series™ | QFET® | TinyBuck™ |
| CorePOWER™ | Gmax™ | QS™ | TinyCalc™ |
| CROSSVOLT™ | GTO™ | Quiet Series™ | TinyLogic® |
| CTL™ | IntelliMAX™ | RapidConfigure™ | TINYOPTO™ |
| Current Transfer Logic™ | ISOPLANAR™ |  ™ | TinyPower™ |
| DEUXPEED® | MegaBuck™ | Saving our world, 1mW/WkW at a time™ | SignalWise™ |
| Dual Cool™ | MICROCOUPLER™ | SmartMax™ | TinyPWM™ |
| EcoSPARK® | MicroFET™ | SMART START™ | TinyWire™ |
| EfficientMax™ | MicroPak™ | SPM® | TriFault Detect™ |
| ESBC™ | MicroPak2™ | STEALTH™ | TRUECURRENT™* |
|  Fairchild® | MillerDrive™ | SuperFET® | µSerDes™ |
| Fairchild Semiconductor® | MotionMax™ | SuperSOT™.3 |  SerDes® |
| FACT Quiet Series™ | Motion-SPM™ | SuperSOT™.6 | UHC® |
| FACT® | mWSaver™ | SuperSOT™.8 | Ultra FRFET™ |
| FAST® | OptoHiT™ | SupreMOS® | UniFET™ |
| FastvCore™ | OPTOLOGIC® | SyncFET™ | VCX™ |
| FETBench™ | OPTOPLANAR® | Sync-Lock™ | VisualMax™ |
| FlashWriter® |  PDP SPM™ |  SYSTEM GENERAL® | XST™ |
| FPST™ | | | |

* Trademarks of System General Corporation, used under license by Fairchild Semiconductor.

DISCLAIMER

FAIRCHILD SEMICONDUCTOR RESERVES THE RIGHT TO MAKE CHANGES WITHOUT FURTHER NOTICE TO ANY PRODUCTS HEREIN TO IMPROVE RELIABILITY, FUNCTION, OR DESIGN. FAIRCHILD DOES NOT ASSUME ANY LIABILITY ARISING OUT OF THE APPLICATION OR USE OF ANY PRODUCT OR CIRCUIT DESCRIBED HEREIN; NEITHER DOES IT CONVEY ANY LICENSE UNDER ITS PATENT RIGHTS, NOR THE RIGHTS OF OTHERS. THESE SPECIFICATIONS DO NOT EXPAND THE TERMS OF FAIRCHILD'S WORLDWIDE TERMS AND CONDITIONS, SPECIFICALLY THE WARRANTY THEREIN, WHICH COVERS THESE PRODUCTS.

LIFE SUPPORT POLICY

FAIRCHILD'S PRODUCTS ARE NOT AUTHORIZED FOR USE AS CRITICAL COMPONENTS IN LIFE SUPPORT DEVICES OR SYSTEMS WITHOUT THE EXPRESS WRITTEN APPROVAL OF FAIRCHILD SEMICONDUCTOR CORPORATION.

As used herein:

- Life support devices or systems are devices or systems which, (a) are intended for surgical implant into the body or (b) support or sustain life, and (c) whose failure to perform when properly used in accordance with instructions for use provided in the labeling, can be reasonably expected to result in a significant injury of the user.
- A critical component in any component of a life support, device, or system whose failure to perform can be reasonably expected to cause the failure of the life support device or system, or to affect its safety or effectiveness.

ANTI-COUNTERFEITING POLICY

Fairchild Semiconductor Corporation's Anti-Counterfeiting Policy. Fairchild's Anti-Counterfeiting Policy is also stated on our external website, www.fairchildsemi.com, under Sales Support.

Counterfeiting of semiconductor parts is a growing problem in the industry. All manufacturers of semiconductor products are experiencing counterfeiting of their parts. Customers who inadvertently purchase counterfeit parts experience many problems such as loss of brand reputation, substandard performance, failed applications, and increased cost of production and manufacturing delays. Fairchild is taking strong measures to protect ourselves and our customers from the proliferation of counterfeit parts. Fairchild strongly encourages customers to purchase Fairchild parts either directly from Fairchild or from Authorized Fairchild Distributors who are listed by country on our web page cited above. Products customers buy either from Fairchild directly or from Authorized Fairchild Distributors are genuine parts, have full traceability, meet Fairchild's quality standards for handling and storage and provide access to Fairchild's full range of up-to-date technical and product information. Fairchild and our Authorized Distributors will stand behind all warranties and will appropriately address any warranty issues that may arise. Fairchild will not provide any warranty coverage or other assistance for parts bought from Unauthorized Sources. Fairchild is committed to combat this global problem and encourage our customers to do their part in stopping this practice by buying direct or from authorized distributors.

PRODUCT STATUS DEFINITIONS

Definition of Terms

Datasheet Identification	Product Status	Definition
Advance Information	Formative / In Design	Datasheet contains the design specifications for product development. Specifications may change in any manner without notice.
Preliminary	First Production	Datasheet contains preliminary data; supplementary data will be published at a later date. Fairchild Semiconductor reserves the right to make changes at any time without notice to improve design.
No Identification Needed	Full Production	Datasheet contains final specifications. Fairchild Semiconductor reserves the right to make changes at any time without notice to improve the design.
Obsolete	Not In Production	Datasheet contains specifications on a product that is discontinued by Fairchild Semiconductor. The datasheet is for reference information only.

Rev. I52