

**SIPMOS<sup>®</sup> Small-Signal-Transistor**
**Features**

- P-Channel
- Enhancement mode
- Normal level
- Avalanche rated
- Pb-free lead plating; RoHS compliant

**Product Summary**

$V_{DS}$	-100	V
$R_{DS(on),max}$	900	m $\Omega$
$I_D$	-0.98	A

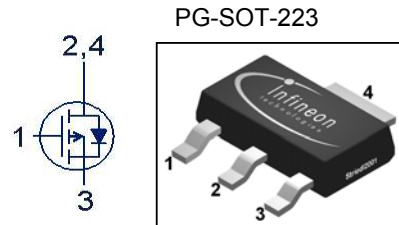

Type	Package	Tape and Reel Information	Marking	Lead free	Packing
BSP321P	PG-SOT-223	L6327: 1000 pcs/reel	BSP321P	Yes	Non dry

**Maximum ratings, at  $T_j=25\text{ °C}$ , unless otherwise specified**

Parameter	Symbol	Conditions	Value	Unit
Continuous drain current	$I_D$	$T_C=25\text{ °C}$	-0.98	A
		$T_C=70\text{ °C}$	-0.79	
Pulsed drain current	$I_{D,pulse}$	$T_C=25\text{ °C}$	-3.9	
Avalanche energy, single pulse	$E_{AS}$	$I_D=-0.98\text{ A}$ , $R_{GS}=25\text{ }\Omega$	57	mJ
Gate source voltage	$V_{GS}$		$\pm 20$	V
Power dissipation	$P_{tot}$	$T_C=25\text{ °C}$	1.8	W
Operating and storage temperature	$T_j$ , $T_{stg}$		-55 ... 150	$^{\circ}\text{C}$
ESD Class		JESD22-A114-HBM	1A (250V to 500V)	
Soldering temperature			260 $^{\circ}\text{C}$	
IEC climatic category; DIN IEC 68-1			55/150/56	

Parameter	Symbol	Conditions	Values			Unit
			min.	typ.	max.	

**Thermal characteristics**

Thermal resistance, junction - ambient	$R_{thJA}$	minimal footprint, steady state	-	-	115	
		6 cm <sup>2</sup> cooling area <sup>1)</sup> , steady state	-	-	70	

**Electrical characteristics, at  $T_j=25\text{ }^\circ\text{C}$ , unless otherwise specified**
**Static characteristics**

Drain-source breakdown voltage	$V_{(BR)DSS}$	$V_{GS}=0\text{ V}, I_D=-250\text{ }\mu\text{A}$	-100	-	-	V
Gate threshold voltage	$V_{GS(th)}$	$V_{DS}=V_{GS}, I_D=-380\text{ }\mu\text{A}$	-2.1	-3.0	-4	
Zero gate voltage drain current	$I_{DSS}$	$V_{DS}=-100\text{ V}, V_{GS}=0\text{ V}, T_j=25\text{ }^\circ\text{C}$	-	-0.1	-1	$\mu\text{A}$
		$V_{DS}=-100\text{ V}, V_{GS}=0\text{ V}, T_j=150\text{ }^\circ\text{C}$	-	-10	-100	
Gate-source leakage current	$I_{GSS}$	$V_{GS}=-20\text{ V}, V_{DS}=0\text{ V}$	-	-10	-100	nA
Drain-source on-state resistance	$R_{DS(on)}$	$V_{GS}=-10\text{ V}, I_D=-0.98\text{ A}$	-	689	900	m $\Omega$
Transconductance	$g_{fs}$	$ V_{DS} >2 I_D R_{DS(on)max}, I_D=-0.79\text{ A}$	0.6	1.2	-	S

<sup>1)</sup> Device on 40 mm x 40 mm x 1.5 mm epoxy PCB FR4 with 6 cm<sup>2</sup> (one layer, 70  $\mu\text{m}$  thick) copper area for drain connection. PCB is vertical in still air.

Parameter	Symbol	Conditions	Values			Unit
			min.	typ.	max.	

**Dynamic characteristics**

Input capacitance	$C_{iss}$	$V_{GS}=0\text{ V}, V_{DS}=-25\text{ V},$ $f=1\text{ MHz}$	-	240	319	pF
Output capacitance	$C_{oss}$		-	62	82	
Reverse transfer capacitance	$C_{rss}$		-	28	42	
Turn-on delay time	$t_{d(on)}$	$V_{DD}=-50\text{ V}, V_{GS}=-$ $10\text{ V}, I_D=-0.98\text{ A},$ $R_G=6\ \Omega$	-	5.9	8.8	ns
Rise time	$t_r$		-	4.4	6.6	
Turn-off delay time	$t_{d(off)}$		-	16.5	24.7	
Fall time	$t_f$		-	8.5	12.7	

**Gate Charge Characteristics<sup>2)</sup>**

Gate to source charge	$Q_{gs}$	$V_{DD}=-80\text{ V}, I_D=-$ $0.98\text{ A}, V_{GS}=0\text{ to }-10\text{ V}$	-	1.1	1.4	nC
Gate to drain charge	$Q_{gd}$		-	4	6	
Gate charge total	$Q_g$		-	9	12	
Gate plateau voltage	$V_{plateau}$		-	4.5	-	V

**Reverse Diode**

Diode continuous forward current	$I_S$	$T_C=25\text{ }^\circ\text{C}$	-	-	-0.98	A
Diode pulse current	$I_{S,pulse}$		-	-	-3.9	
Diode forward voltage	$V_{SD}$	$V_{GS}=0\text{ V}, I_F=0.98\text{ A},$ $T_j=25\text{ }^\circ\text{C}$	-	0.84	1.2	V
Reverse recovery time	$t_{rr}$	$V_R=50\text{ V}, I_F= I_S ,$ $di_F/dt=100\text{ A}/\mu\text{s}$	-	47	-	ns
Reverse recovery charge	$Q_{rr}$		-	96	-	nC

<sup>2)</sup> See figure 16 for gate charge parameter definition

**1 Power dissipation**

$$P_{\text{tot}} = f(T_C)$$

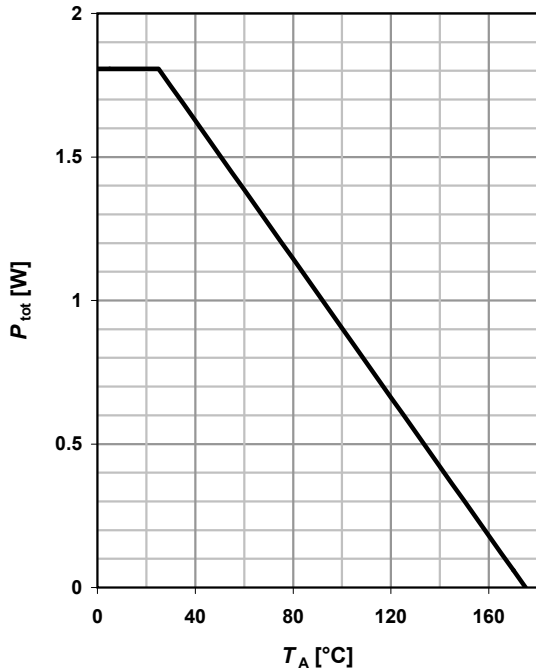

**2 Drain current**

$$I_D = f(T_C); |V_{GS}| \geq 10 \text{ V}$$

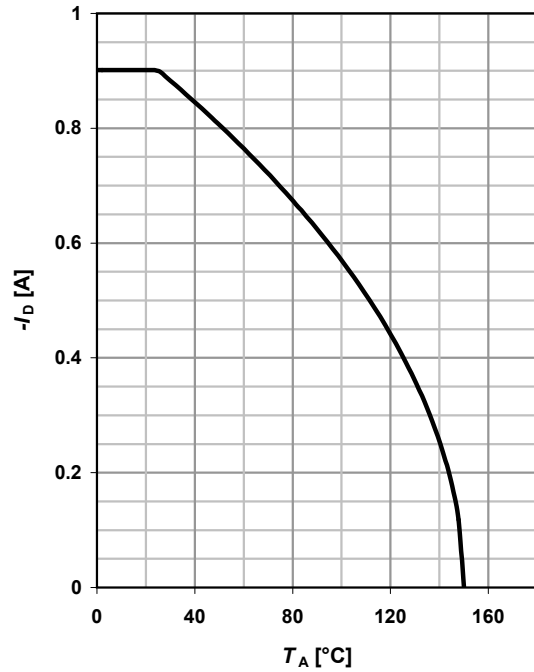

**3 Safe operating area**

$$I_D = f(V_{DS}); T_C = 25 \text{ °C}; D = 0$$

parameter:  $t_p$

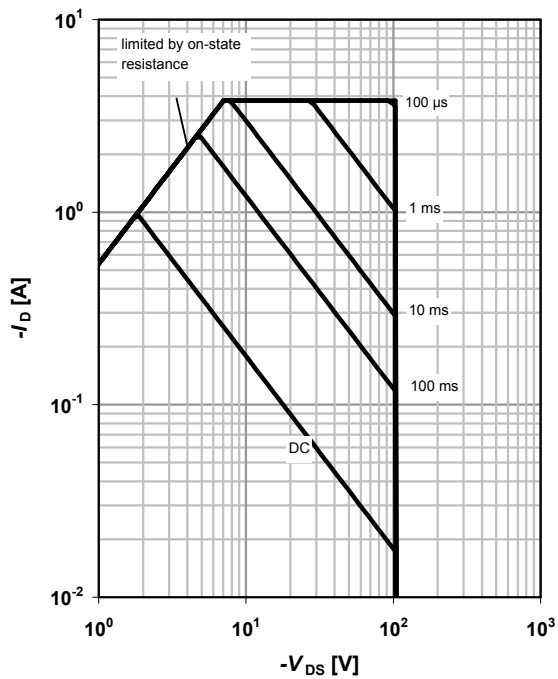

**4 Max. transient thermal impedance**

$$Z_{\text{thJC}} = f(t_p)$$

parameter:  $D = t_p / T$

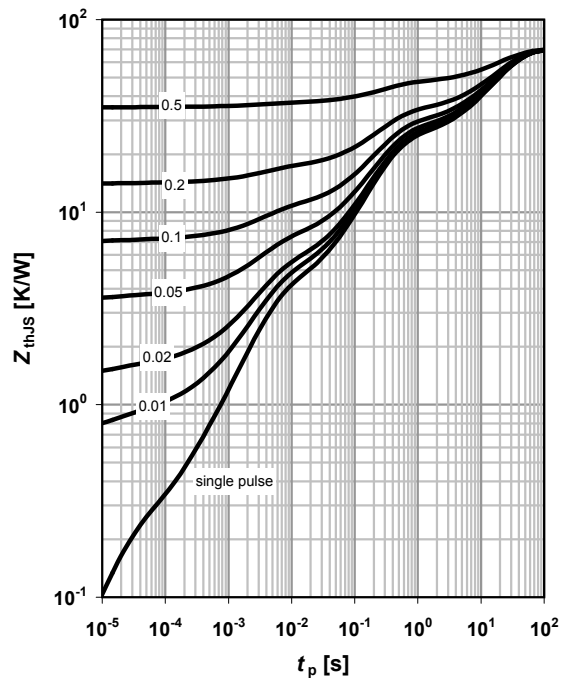

**5 Typ. output characteristics**

$I_D = f(V_{DS}); T_j = 25\text{ }^\circ\text{C}$

parameter:  $V_{GS}$

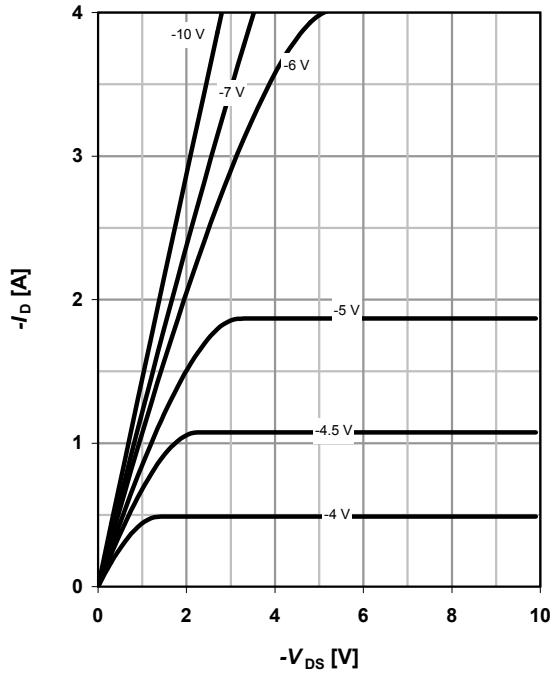

**6 Typ. drain-source on resistance**

$R_{DS(on)} = f(I_D); T_j = 25\text{ }^\circ\text{C}$

parameter:  $V_{GS}$

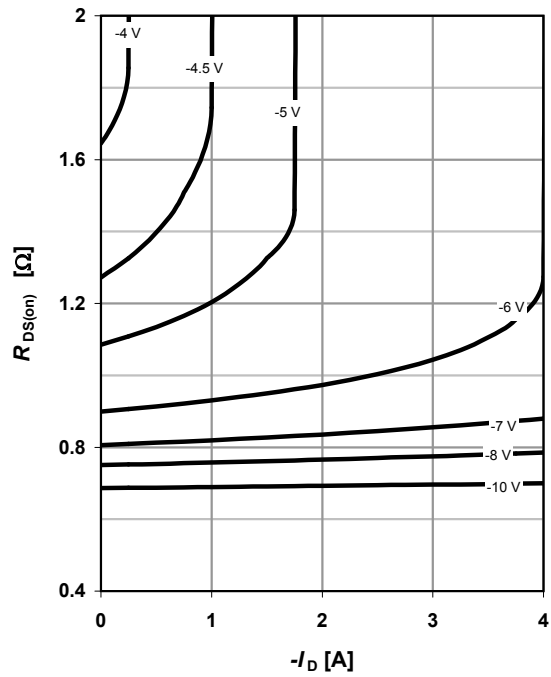

**7 Typ. transfer characteristics**

$I_D = f(V_{GS}); |V_{DS}| > 2|I_D|R_{DS(on)max}$

parameter:  $T_j$

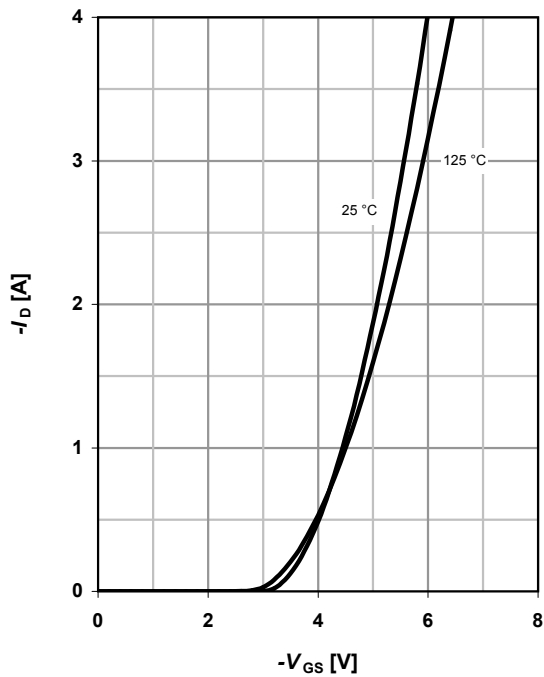

**8 Typ. forward transconductance**

$g_{fs} = f(I_D); T_j = 25\text{ }^\circ\text{C}$

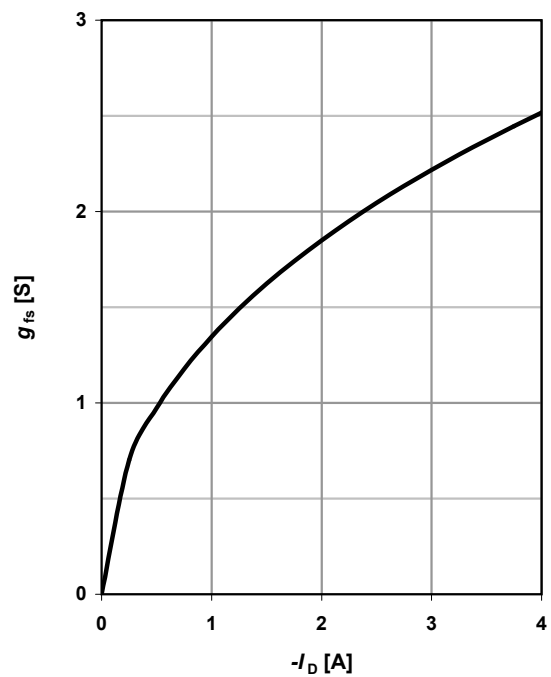

**9 Drain-source on-state resistance**

$R_{DS(on)}=f(T_j); I_D=-0.98\text{ A}; V_{GS}=-10\text{ V}$

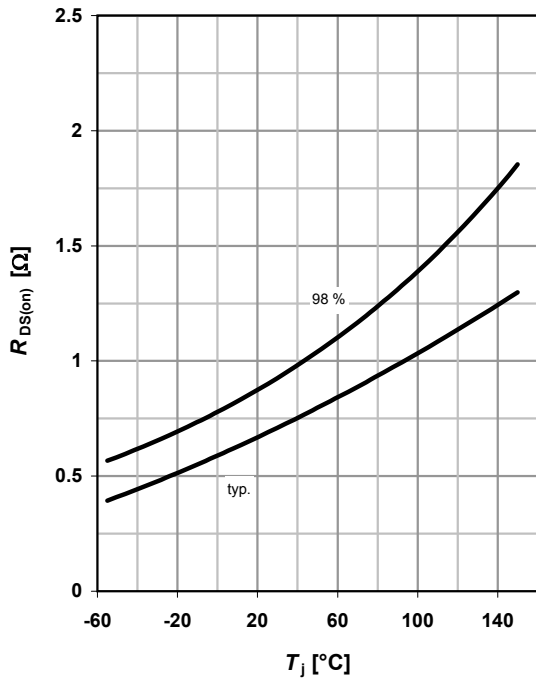

**10 Typ. gate threshold voltage**

$V_{GS(th)}=f(T_j); V_{GS}=V_{DS}; I_D=-380\ \mu\text{A}$

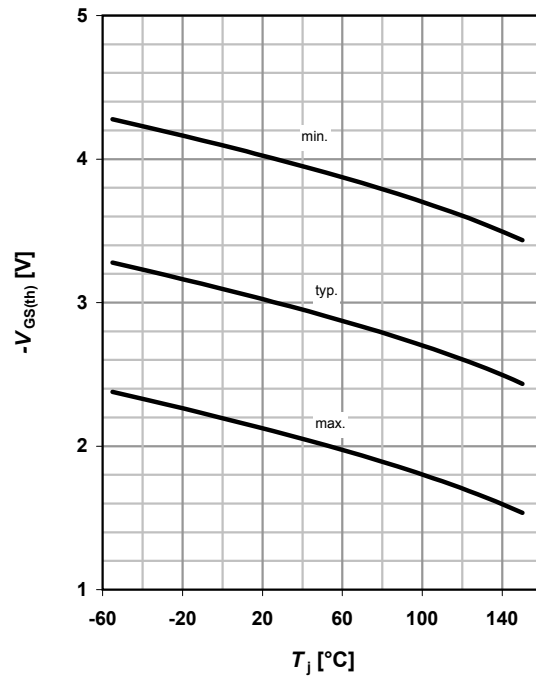

**11 Typ. capacitances**

$C=f(V_{DS}); V_{GS}=0\text{ V}; f=1\text{ MHz}$

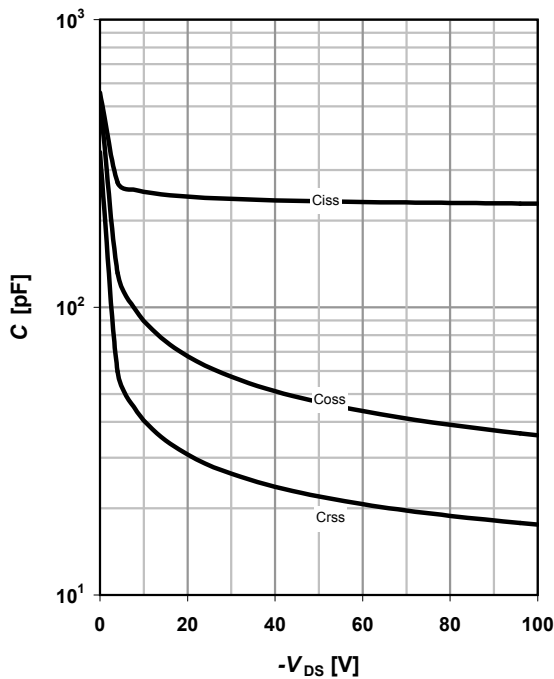

**12 Forward characteristics of reverse diode**

$I_F=f(V_{SD})$

parameter:  $T_j$

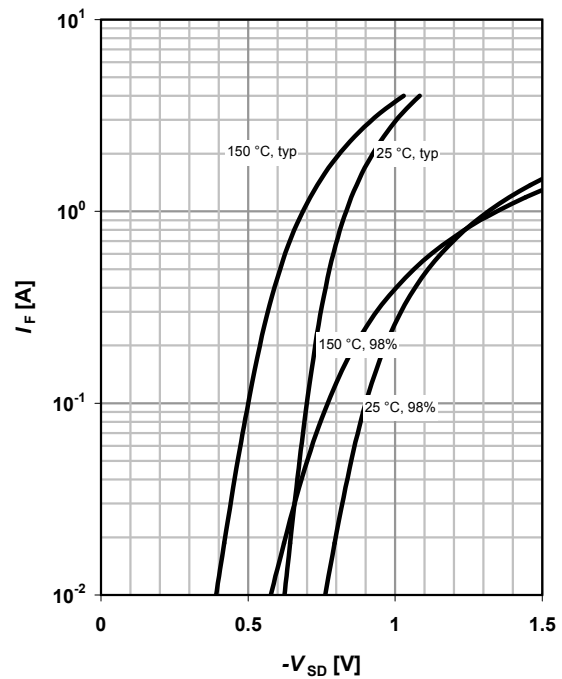

**13 Avalanche characteristics**

$I_{AS}=f(t_{AV}); R_{GS}=25 \Omega$

parameter:  $T_{j(start)}$

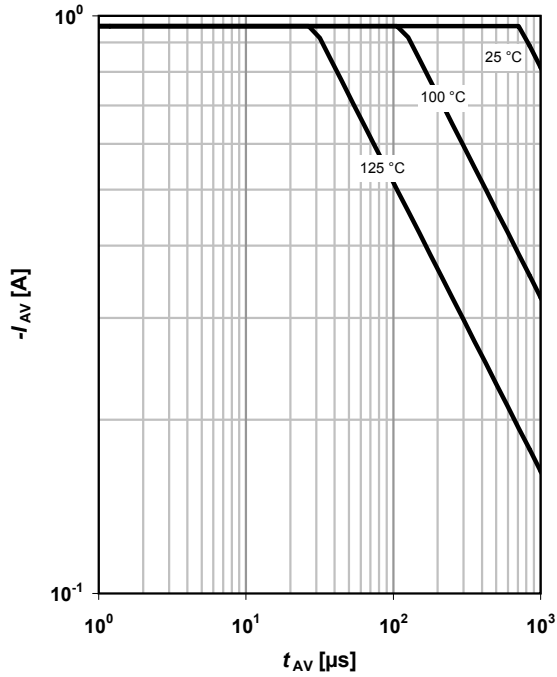

**14 Typ. gate charge**

$V_{GS}=f(Q_{gate}); I_D=-0.98 \text{ A pulsed}$

parameter:  $V_{DD}$

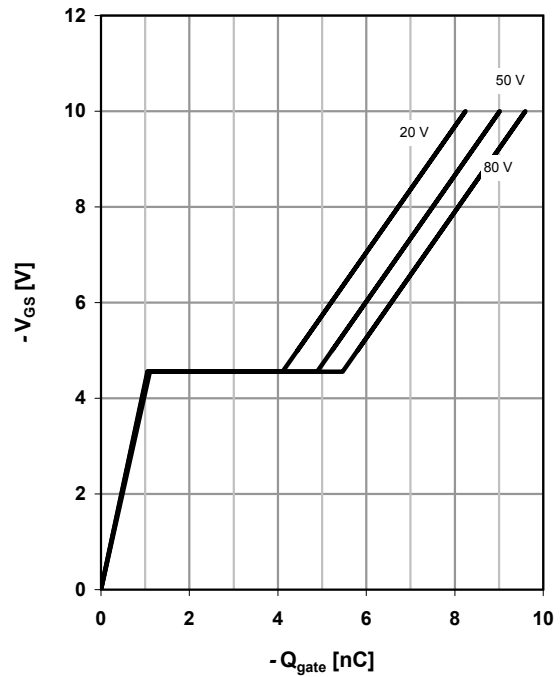

**15 Drain-source breakdown voltage**

$V_{BR(DSS)}=f(T_j); I_D=-250 \mu\text{A}$

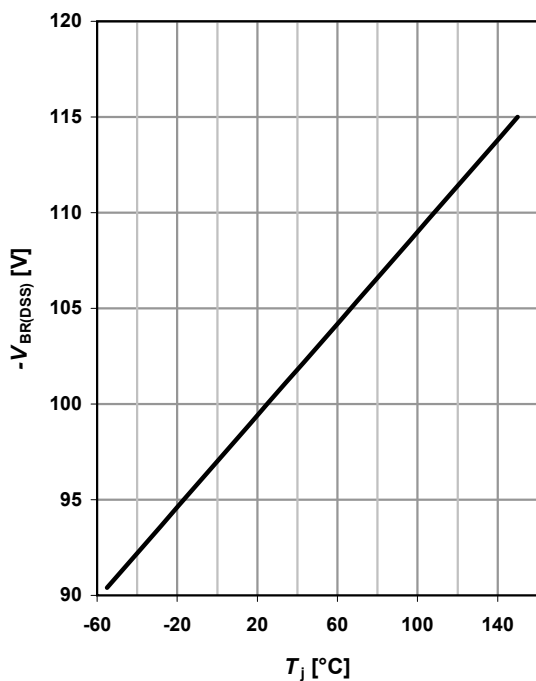

**16 Gate charge waveforms**

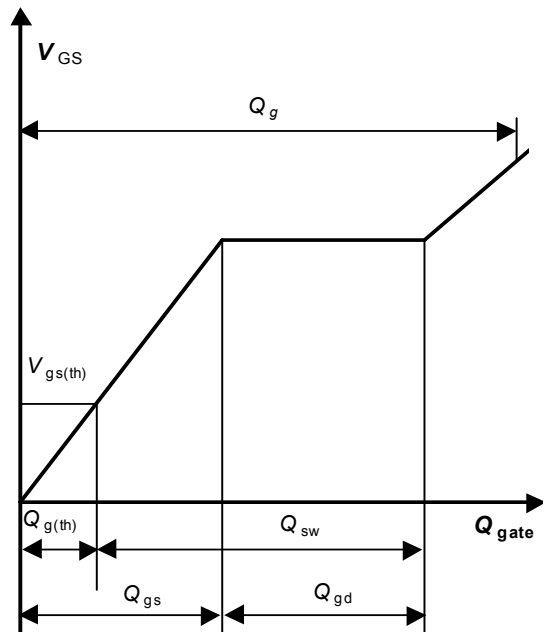

Package Outline: PG-SOT-223

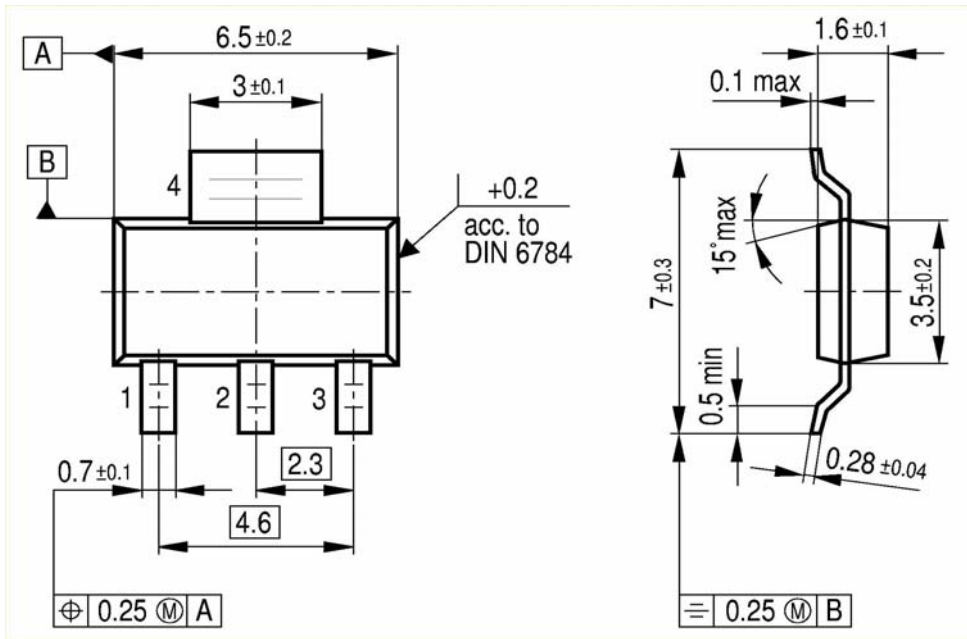

Footprint:

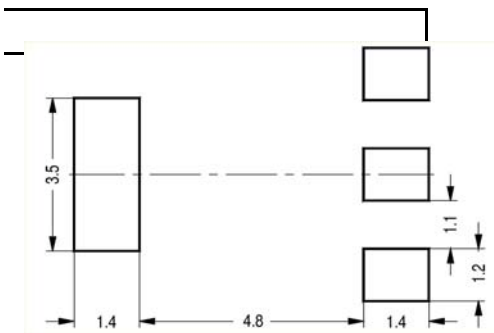

Packaging:

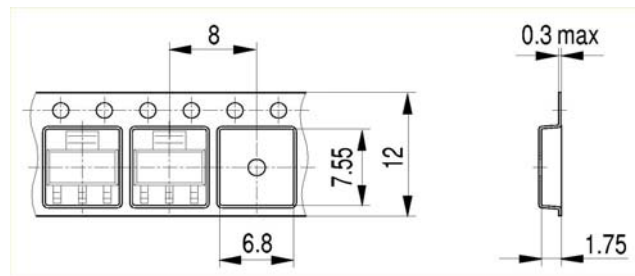

Dimensions in mm



**Published by****Infineon Technologies AG****81726 München, Germany****© Infineon Technologies AG 2006.****All Rights Reserved.****Attention please!**

The information given in this data sheet shall in no event be regarded as a guarantee of conditions or characteristics ("Beschaffenheitsgarantie"). With respect to any examples or hints given herein, any typical values stated herein and/or any information regarding the application of the device, Infineon Technologies hereby disclaims any and all warranties and liabilities of any kind, including without limitation warranties of non-infringement of intellectual property rights of any third party.

**Information**

For further information on technology, delivery terms and conditions and prices please contact your nearest Infineon Technologies Office ([www.infineon.com](http://www.infineon.com)).

**Warnings**

Due to technical requirements components may contain dangerous substances. For information on the types in question please contact your nearest Infineon Technologies Office.

Infineon Technologies Components may only be used in life-support devices or systems with the express written approval of Infineon Technologies, if a failure of such components can reasonably be expected to cause the failure of that life-support device or system, or to affect the safety or effectiveness of that device or system. Life support devices or systems are intended to be implanted in the human body, or to support and/or maintain and sustain and/or protect human life. If they fail, it is reasonable to assume that the health of the user or other persons may be endangered.