



A COMPANY OF STPI GROUP

E405 & ES405

Military Specified

Meets MIL-PRF-83536

General Characteristics

Number of Poles:

Dimensions:

Weight:

-Mounting Code 18:

4 Form C (4PDT)

0.810" x 0.810" x 0.640"

(20.6mm x 20.6mm x 16.3mm)

0.058 lb. (26.4 grams)

0.072 lb. (32.6 grams)

Switching Characteristics

Operate Time @ 25°C:

Release Time @ 25°C:

Bounce Time:

Mechanical Life:

6 ms Max.

6 ms Max.

1 ms Max.

400,000 Cycles

Environmental Characteristics

Temperature Range:

Vibration (Sinusoidal):

-Mounting Code 04:

-Mounting Code 03:

Shock (any axis):

-Mounting Code 03:

Seal:

-70°C to +125°C

30g 70-3,000 Hz

.06" Double Amplitude 10-55 Hz,

10g 55-500 Hz, 20g 500-3,000 Hz

20g 57-3,000 Hz

200g, 6 ms

100g, 6 ms

Hermetic (1x10⁻⁸ atm cm³/s)

Electrical Characteristics

Contact Voltage Drop (at rated resistive load)

-Initial:

-After Guaranteed Life:

-Max. Leakage Current (Mounting Code 18):

Dielectric Strength

Coil to Case @ Sea Level

-Initial @ 60 Hz:

-After Life Test @ 60 Hz:

All Other Points @ Sea Level

-Initial @ 60 Hz:

-After Life Test @ 60 Hz:

Coil to Case @ Sea Level (Mounting Code 18)

-Initial @ 60 Hz:

-After Life Test @ 60 Hz:

All Other Points @ Sea Level (Mounting Code 18)

-Initial @ 60 Hz:

-After Life Test @ 60 Hz:

Insulation Resistance

-Initial:

-After Life Tests:

Back EMF (Transient Voltage):

150 mV Max.

175 mV Max.

100 μ A RMS

1,000 Vrms

750 Vrms

1,000 Vrms

750 Vrms

1,050 Vrms

1,050 Vrms

1,050 Vrms

1,050 Vrms

100 M Ω Min, @ 500 Vdc

50 M Ω Min, @ 500 Vdc

42 Vdc Max. (ES405 Only)

Contact Rating (Amps)

Type of Load (High Level)	Cycles x 10 ³	28 Vdc	115 Vac 400 Hz 1 Phase	115/200 Vac 50/60 Hz 3 Phase
Resistive	100	5	5	5
Inductive	20	3	5	5
Motor	100	2	3	3
Lamp	100	1	N/A	N/A

Circuit Diagram

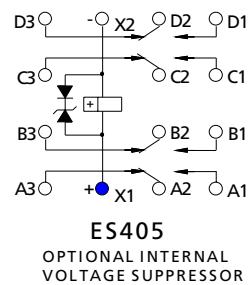
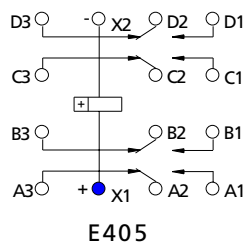

Military Part Numbering

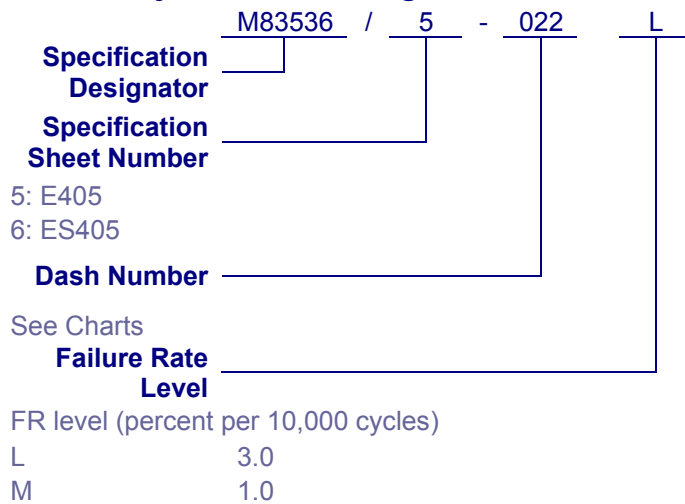

QPL Part Numbering

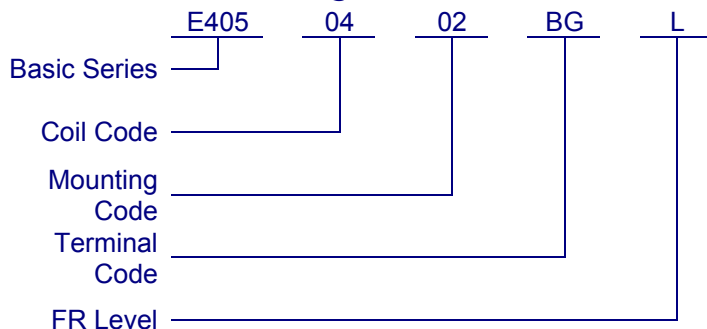



A COMPANY OF STPI GROUP

Dash Numbers – Specification Sheet Number 5: E405

Dash Number	Coil Code	Mount	Terminals	Coil Voltage	Max Pickup Voltage at 25°C	Max Pickup Voltage at 125°C	Max Hold Voltage at 125°C	Min Dropout Voltage at -70°C	Coil Resistance (Ω, +/- 10% at 25°C)
009	02	01	CT	12	6.5	9	4.5	0.5	72
010	02	01	AT	12	6.5	9	4.5	0.5	72
011	02	01	BG	12	6.5	9	4.5	0.5	72
012	02	02	CT	12	6.5	9	4.5	0.5	72
013	02	02	AT	12	6.5	9	4.5	0.5	72
014	02	02	BG	12	6.5	9	4.5	0.5	72
015	02	03	CT	12	6.5	9	4.5	0.5	72
016	02	03	AT	12	6.5	9	4.5	0.5	72
017	04	01	CT	28	13.5	18	7	1.5	400
018	04	01	AT	28	13.5	18	7	1.5	400
019	04	01	BG	28	13.5	18	7	1.5	400
020	04	02	CT	28	13.5	18	7	1.5	400
021	04	02	AT	28	13.5	18	7	1.5	400
022	04	02	BG	28	13.5	18	7	1.5	400
023	04	03	CT	28	13.5	18	7	1.5	400
024	04	03	AT	28	13.5	18	7	1.5	400

Dash Numbers – Specification Sheet Number 6: ES405

Dash Number	Coil Code	Mount	Terminals	Coil Voltage	Max Pickup Voltage at 25°C	Max Pickup Voltage at 125°C	Max Hold Voltage at 125°C	Min Dropout Voltage at -70°C	Coil Resistance (Ω, +/- 10% at 25°C)
009	02	01	CT	12	6.5	9	4.5	0.5	72
010	02	01	AT	12	6.5	9	4.5	0.5	72
011	02	01	BG	12	6.5	9	4.5	0.5	72
012	02	02	CT	12	6.5	9	4.5	0.5	72
013	02	02	AT	12	6.5	9	4.5	0.5	72
014	02	02	BG	12	6.5	9	4.5	0.5	72
015	02	03	CT	12	6.5	9	4.5	0.5	72
016	02	03	AT	12	6.5	9	4.5	0.5	72
017	04	01	CT	28	13.5	18	7	1.5	400
018	04	01	AT	28	13.5	18	7	1.5	400
019	04	01	BG	28	13.5	18	7	1.5	400
020	04	02	CT	28	13.5	18	7	1.5	400
021	04	02	AT	28	13.5	18	7	1.5	400
022	04	02	BG	28	13.5	18	7	1.5	400
023	04	03	CT	28	13.5	18	7	1.5	400
024	04	03	AT	28	13.5	18	7	1.5	400
025	04	04	BG	28	13.5	18	7	1.5	400
026	00	18	KG	28	13.5	18	7	1.5	400

Mounting Styles

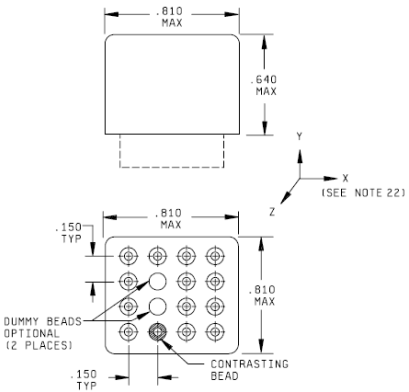

Mount 01:
No Mount

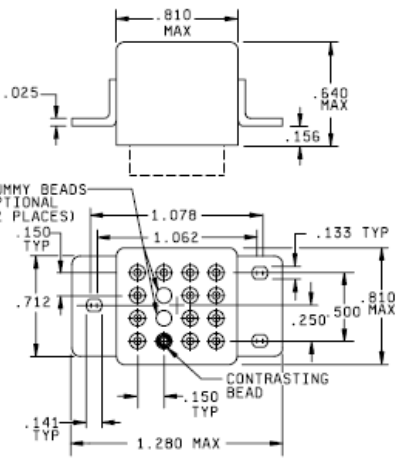
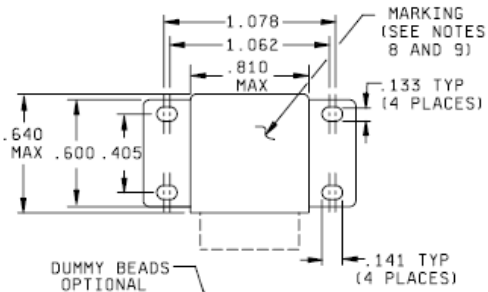

Mount 02:
Raised Vertical Flange Mount

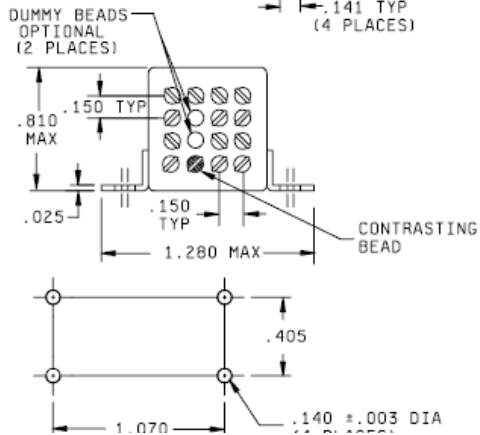

Mount 03:
Horizontal Flange Mount

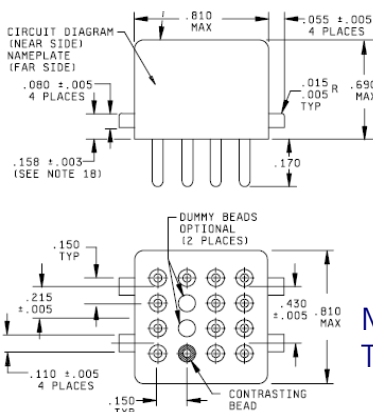

Mount 04:
Track Mount A

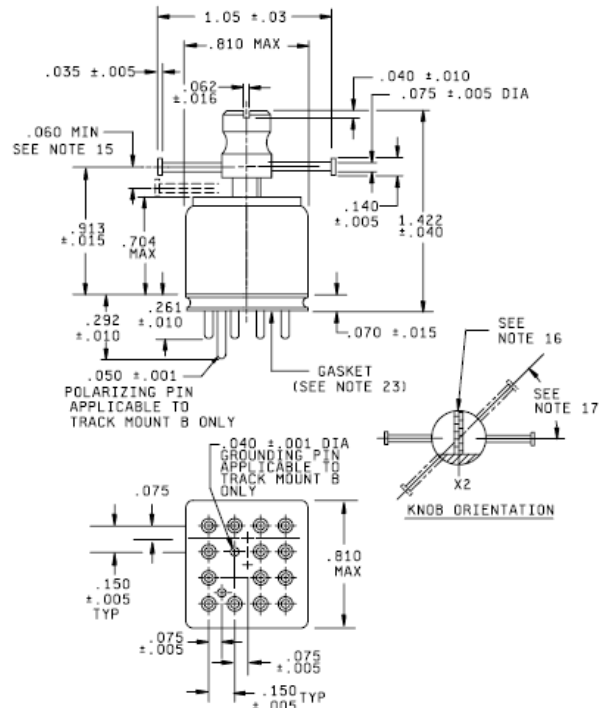
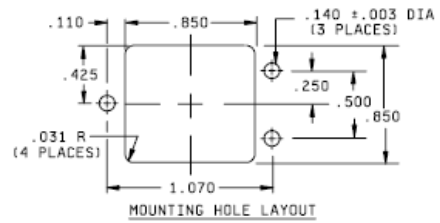

Mount 18:
Track Mount B

Terminal Styles

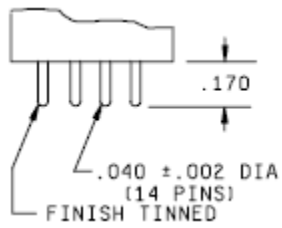

Terminal CT:
Tin Plated Solder Pin

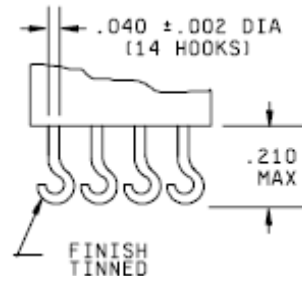

Terminal AT:
Tin Plated Solder Hook

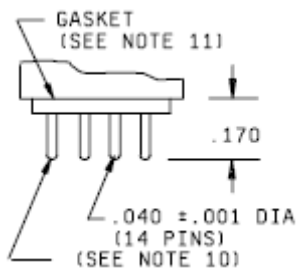

Terminal BG & KG:
Gold Plated Plug in
Note: Grounding Pin not shown
for mount KG