

# FAN6863W

## Highly Integrated Green-Mode PWM Controller

### Features

- Low Standby Power: Under 0.1W
- Low Startup Current: 8μA
- Low Operating Current in Green Mode: 600μA
- Peak-Current Mode Operation with Cycle-by-Cycle Current Limiting
- PWM Frequency Continuously Decreasing with Burst Mode at Light Loads
- V<sub>DD</sub> Over-Voltage Protection (OVP)
- Constant Output Power Limit (Full AC Input Range)
- Internal Latch Circuit (FAN6863WL) for OVP, OTP
- SENSE Pin Short-Circuit Protection (SSCP)
- Fixed PWM Frequency (65KHz) with Frequency Hopping
- Feedback Open-Loop Protection: 60ms Delay
- GATE Output Maximum Voltage Clamp: 13.5V
- Soft-Start Time: 5ms
- Soft Driving for EMI Improvement
- Full Range Frequency Hopping
- Internal OTP Sensor with Hysteresis
- Gate Driving Capability: 400mA

### Applications

General-purpose switched-mode power supplies and flyback power converters, including:

- Power Adapters
- Open-Frame SMPS
- SMPS with Surge-Current Output, such as for Printers, Scanners, Motor Drivers

### Description

A highly integrated PWM controller, FAN6863W provides several features to enhance the performance of flyback converters. To minimize standby power consumption, a proprietary Green Mode provides off-time modulation to continuously decrease the switching frequency under light-load conditions. Under zero-load conditions, the power supply enters Burst Mode, which completely shuts off PWM output. Output restarts just before the supply voltage drops below the UVLO lower limit. Green Mode enables power supplies to meet international power conservation requirements.

The FAN6863W is designed for SMPS and integrates a frequency-hopping function that helps to reduce EMI emission of a power supply with minimum line filters. To compensate the power limit variation over universal input range, a current limit (V<sub>LIMIT</sub>) adaptively keeps the power limit substantially constant. The gate output is clamped at 13.5V to protect the external MOSFET from over-voltage damage.

Other protection functions include SENSE pin Short-Circuit Protection (SSCP), V<sub>DD</sub> Over-Voltage Protection (OVP), and Over-Temperature Protection (OTP). For OTP, an external NTC thermistor can be applied to sense the ambient temperature. When V<sub>DD</sub> OVP or OTP is activated, an internal latch circuit latches off the controller. Protection types are shown in Table 1.

**Table 1. Protection Type**

Part Number	OVP	OLP	OTP / OTP2	SSCP
FAN6863W	Latch	A/R	Latch	A/R
FAN6863WL	Latch	Latch	Latch	A/R
FAN6863WR	A/R	A/R	A/R	A/R

### Ordering Information

Part Number	Operating Temperature Range	Package	Packing Method
FAN6863WTY	-40 to +105°C	6-Lead, SuperSOT™-6, JEDEC M0-193, 1.6mm Wide	Tape & Reel
FAN6863WLT			
FAN6863WRT			

### Typical Application

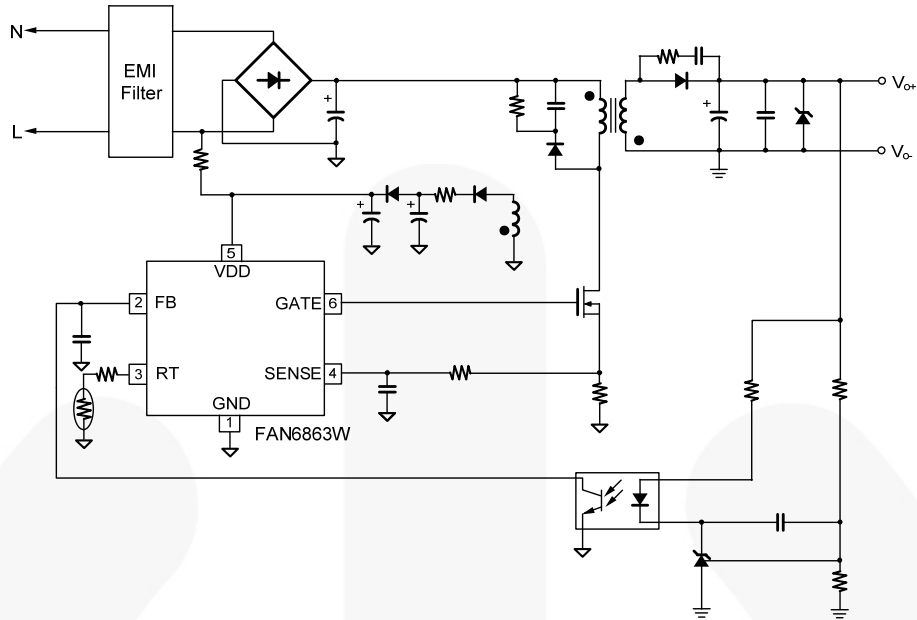


Figure 1. Typical Application

### Block Diagram

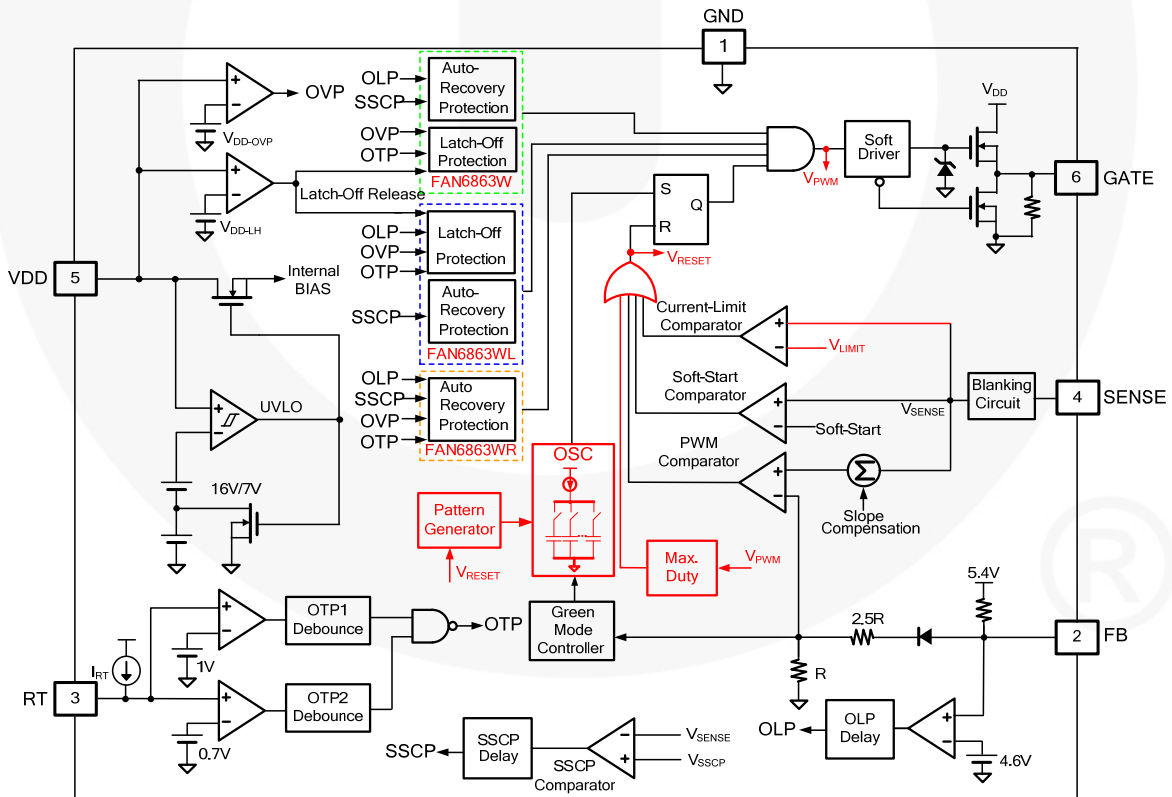


Figure 2. Block Diagram

## Marking Information

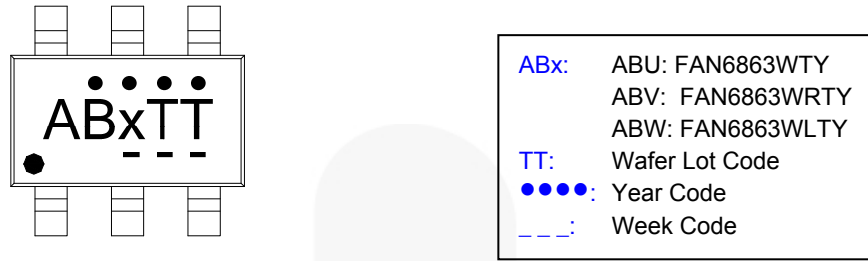


Figure 3. Top Mark

## Pin Configuration

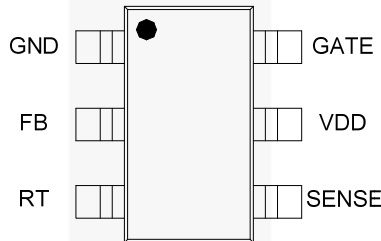


Figure 4. Pin Configuration

## Pin Definitions

Pin #	Name	Function	Description
1	GND	Ground	Ground
2	FB	Feedback	The FB pin provides the output voltage regulation signal. It provides feedback to the internal PWM comparator, so the PWM comparator can control the duty cycle. This pin also provides over-current protection. If $V_{FB}$ is higher than the trigger level and persists at that level, the controller stops and restarts.
3	RT	Temperature Detection	An external NTC thermistor is connected from this pin to the GND pin. The impedance of the NTC decreases at high temperatures. If the voltage of the RT pin drops below the threshold, PWM output is disabled.
4	SENSE	Current Sense	This pin senses the voltage across a resistor. When the voltage reaches the internal threshold, PWM output is disabled and this activates over-current protection. This pin also provides current amplitude information for Current Mode control.
5	VDD	Power Supply	Power supply
6	GATE	Driver Output	The totem-pole output driver for driving the power MOSFET

## Absolute Maximum Ratings

Stresses exceeding the absolute maximum ratings may damage the device. The device may not function or be operable above the recommended operating conditions and stressing the parts to these levels is not recommended. In addition, extended exposure to stresses above the recommended operating conditions may affect device reliability. The absolute maximum ratings are stress ratings only. All voltage values, except differential voltages, are given with respect to GND pin.

Symbol	Parameter	Min.	Max.	Unit
$V_{DD}$	Supply Voltage		30	V
$V_L$	Input Voltage to FB, SENSE, and RT Pins	-0.3	7.0	V
$\Theta_{JA}$	Thermal Resistance (Junction-to-Ambient)		244	°C/W
$T_J$	Operating Junction Temperature	-40	+125	°C
$T_{STG}$	Storage Temperature Range	-55	+150	°C
$T_L$	Lead Temperature, Wave Soldering, 10 Seconds		+260	°C
ESD	Human Body Model, JESD22-A114		5.5	kV
	Charge Device Model, JESD22-C101		2.0	

## Recommended Operating Conditions

The Recommended Operating Conditions table defines the conditions for actual device operation. Recommended operating conditions are specified to ensure optimal performance to the datasheet specifications. Fairchild does not recommend exceeding them or designing to Absolute Maximum Ratings.

Symbol	Parameter	Min.	Max.	Unit
$T_A$	Operating Ambient Temperature	-40	+105	°C

## Electrical Characteristics

$V_{DD} = 15V$  and  $T_A = 25^\circ C$ , unless otherwise noted.

Symbol	Parameter	Condition	Min.	Typ.	Max.	Unit
<b>V<sub>DD</sub> Section</b>						
$V_{DD-OP}$	Continuously Operating Voltage				20	V
$V_{DD-ON}$	Turn-On Threshold Voltage		15	16	17	V
$V_{DD-OFF}$	Turn-Off Voltage		6.5	7.0	7.5	V
$V_{DD-LH}$	Threshold Voltage for Latch-Off Release			4		V
$I_{DD-ST}$	Startup Current	$V_{DD-ON} - 0.16V$		8	15	$\mu A$
$I_{DD-OP1}$	Operating Supply Current in PWM Operation	$V_{DD} = 20V$ , $V_{FB} = 3V$ Gate Open			2	mA
$I_{DD-OP2}$	Operating Supply Current when $V_{FB} < V_{FB-ZDC}$	$V_{DD} = 15V$ , $V_{FB} < V_{FB-ZDC}$		600		$\mu A$
$V_{DD-OVP}$	$V_{DD}$ Over-Voltage Protection	FAN6863WL-Latch, FAN6863WR-Auto Restart	21.2	22.2	23.2	V
$t_{D-VDDOVP}$	$V_{DD}$ OVP Debounce Time			50		$\mu s$
$I_{DD-LH}$	Latch-Off Holding Current	$V_{DD} = 5V$ ; FAN6863W, FAN6863WL Only		70	80	$\mu A$
<b>Feedback Input Section</b>						
$A_V$	Input-Voltage to Current-Sense Attenuation		1/4.0	1/3.5	1/3.0	V/V
$Z_{FB}$	Input Impedance			17		k $\Omega$
$V_{FB-OPEN}$	FB Pin Open Voltage		5.2	5.4	5.6	V
$V_{FB-OLP}$	Threshold Voltage for Open-Loop Protection		4.3	4.6	4.9	V
$t_{D-OLP}$	Open-Loop Protection Delay	$V_{FB} > V_{FB-OLP}$ , $t_{ON} > 2.5\mu s$ , $T_A = -40$ to $+105^\circ C$	54	60	66	ms
$t_{D-SCP}$	Secondary Short-Circuit Protection Delay	$FB > V_{FB-OLP}$ , $t_{ON} < 2.5\mu s$ , $T_A = -40$ to $+105^\circ C$	6	7	8	ms
$t_{ON-SCP}$	Short-Circuit Protection On-Time Detection	$V_{FB} > V_{FB-OLP}$ , $T_A = -40$ to $+105^\circ C$		2.5		$\mu s$
<b>Current Sense Section</b>						
$t_{PD}$	Delay to Output			100	250	ns
$t_{LEB}$	Leading-Edge Blanking Time		200	250		ns
$V_{LIMIT-H}$	HIGH Threshold Voltage for Current Limit	Duty > 55%	0.57	0.60	0.63	V
$V_{LIMIT-L}$	LOW Threshold Voltage for Current Limit	Duty = 0%	0.36	0.39	0.42	V
$t_{SOFT-START}$	Period During Startup Time	Startup Time	4.75	5.00	10.00	ms
$V_{SSCP}$	Threshold Voltage for SENSE Short-Circuit Protection	$t_{ON} > 4.5\mu s$ , $FB < V_{FB-OLP}$ , $T_A = -40$ to $+105^\circ C$		110		mV
$t_{ON-SSCP}$	Detect SENSE On Time for SENSE Short-Circuit Protection			4.4		$\mu s$
$t_{SSCP}$	Debounce Time for SENSE Short-Circuit Protection	$t_{ON} > 4.5\mu s$ , $V_{FB} < V_{FB-OLP}$ , $T_A = -40$ to $+105^\circ C$		100		$\mu s$

Continued on the following page...

### Electrical Characteristics (Continued)

$V_{DD} = 15$  and  $T_A = 25^\circ\text{C}$ , unless otherwise noted.

Symbol	Parameter	Condition	Min.	Typ.	Max.	Unit	
<b>Oscillator Section</b>							
$f_{OSC}$	Normal PWM Frequency	Center Frequency	$V_{FB} > V_{FB-N}$	60	65	68	kHz
		Hopping Range	$V_{FB} \geq V_{FB-N}$		$\pm 4.0$		
			$V_{FB} = V_{FB-G}$		$\pm 2.9$		
$t_{hop-1}$	Hopping Period 1	$V_{FB} \geq V_{FB-N}$		4.4		ms	
$t_{hop-3}$	Hopping Period 3	$V_{FB} = V_{FB-G}$		11.5		ms	
$f_{OSC-G}$	Green Mode Minimum Frequency		18	22	26	kHz	
$V_{FB-N}$	FB Threshold Voltage for Frequency Reduction		2.4	2.5	2.6	V	
$V_{FB-G}$	FB Voltage at $f_{OSC-G}$		2.1	2.2	2.3	V	
$V_{FB-ZDC}$	FB Threshold Voltage for Zero-Duty			1.6		V	
$V_{FB-ZDCR} - V_{FB-ZDC}$	ZDC Hysteresis			0.15		V	
$f_{DV}$	Frequency Variation vs. $V_{DD}$ Deviation	$V_{DD} = 7.5\text{V to }21\text{V}$		0.5	2.0	%	
$f_{DT}$	Frequency Variation vs. Temperature Deviation	$T_A = -40 \text{ to } +105^\circ\text{C}$			2	%	

Continued on following page...

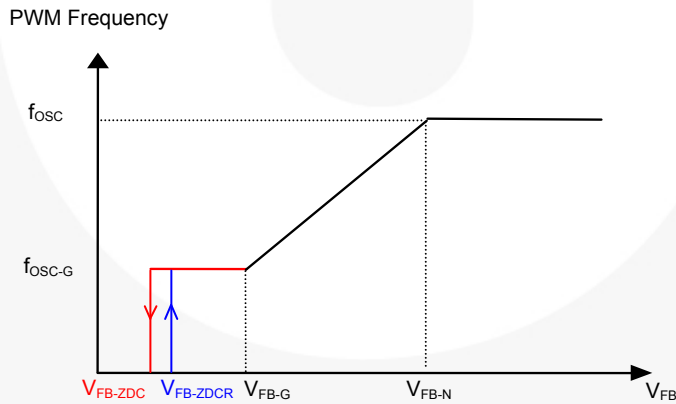


Figure 5. PWM Frequency

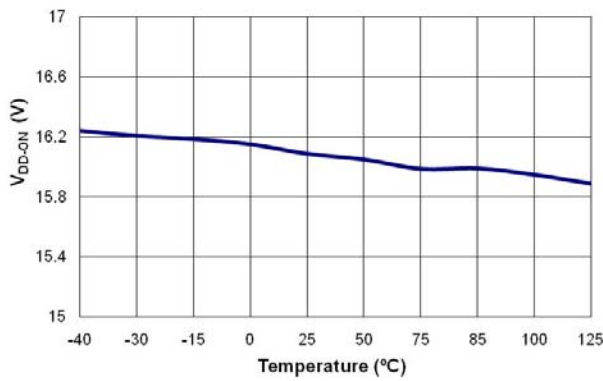
**Electrical Characteristics** (Continued)V<sub>DD</sub> = 15V and T<sub>A</sub> = 25°C, unless otherwise noted.

Symbol	Parameter	Condition	Min.	Typ.	Max.	Unit
<b>PWM Output Section</b>						
DCY <sub>MAX</sub>	Maximum Duty Cycle		68	75	85	%
V <sub>OL</sub>	Output Voltage LOW	V <sub>DD</sub> = 15V, I <sub>O</sub> = 50mA			1.5	V
V <sub>OH</sub>	Output Voltage HIGH	V <sub>DD</sub> = 8V, I <sub>O</sub> = 50mA	6			V
t <sub>R</sub>	Rising Time (with Soft Driving)	GATE = 1nF		150		ns
t <sub>F</sub>	Falling Time	GATE = 1nF		35		ns
V <sub>CLAMP</sub>	Gate Output Clamping Voltage	V <sub>DD</sub> = 20V	12.0	13.5	15.0	V
I <sub>O-SOURCE</sub>	Gate Source Driving Capability	V <sub>DD</sub> = 15V		400		mA
I <sub>O-SINK</sub>	Gate Sink Driving Capability	V <sub>DD</sub> = 15V		400		mA
<b>Over-Temperature Protection (OTP) Section</b>						
R <sub>RT</sub>	Maximum External Resistance of RT Pin to Trigger Protection		9.2	10	11	kΩ
V <sub>OTP</sub>	Threshold Voltage for Over-Temperature Protection	FAN6863W, FAN6863WL-Latch, FAN6863WR-Auto Restart, at 25°C	0.95	1.00	1.05	V
I <sub>RT</sub>	Output Current of RT Pin		92	100	108	μA
t <sub>DOTP</sub>	Over-Temperature Debounce Time	V <sub>FB</sub> =V <sub>FB-N</sub>	15	17	19	ms
V <sub>OTP2</sub>	Second Threshold Voltage for Over-Temperature Protection	FAN6863W, FAN6863WL-Latch, FAN6863WR-Auto Restart, at 25°C	0.65	0.70	0.75	V
t <sub>DOTP2</sub>	Second Over-Temperature Debounce Time		80	135	200	μs
T <sub>OTP</sub>	Protection Junction Temperature <sup>(1)</sup>			+135		°C
T <sub>Restart</sub>	Restart Junction Temperature <sup>(2)</sup>			T <sub>OTP</sub> - 25		°C

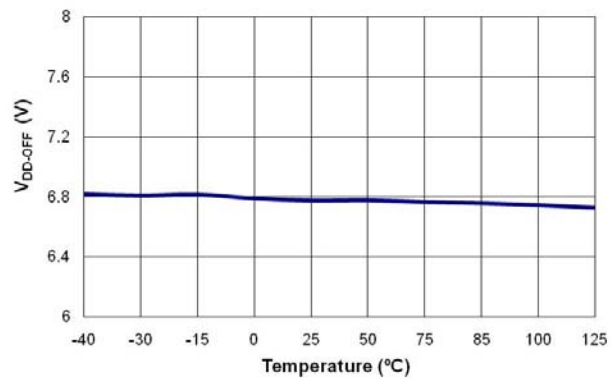
**Notes:**

- When activated, the output is disabled and the latch is turned off.
- The threshold temperature for enabling the output again and resetting the latch after OTP has been activated.

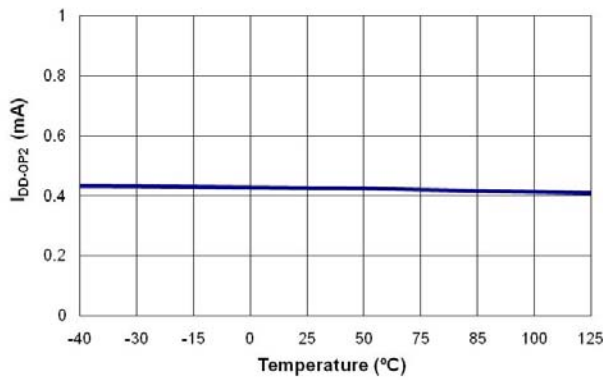
## Typical Performance Characteristics



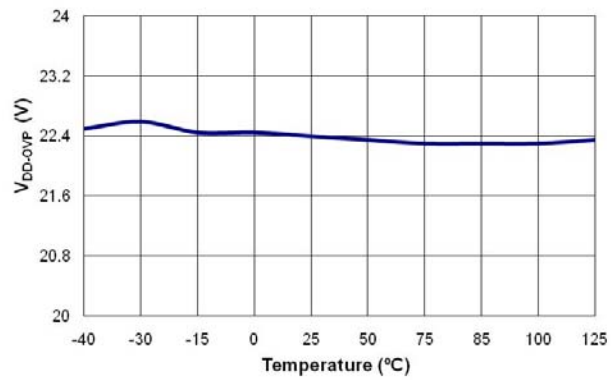
**Figure 6. Turn-On Threshold Voltage (V<sub>DD-ON</sub>) vs. Temperature**



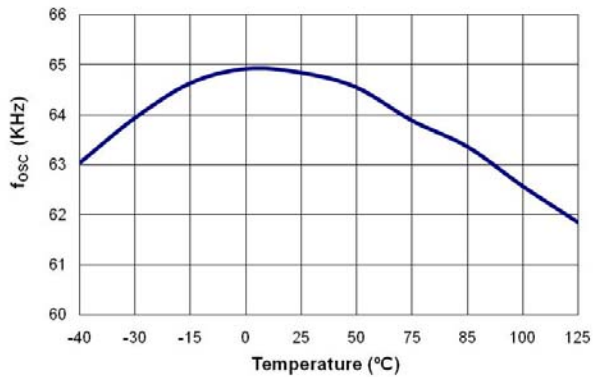
**Figure 7. Turn-Off Threshold Voltage (V<sub>DD-OFF</sub>) vs. Temperature**



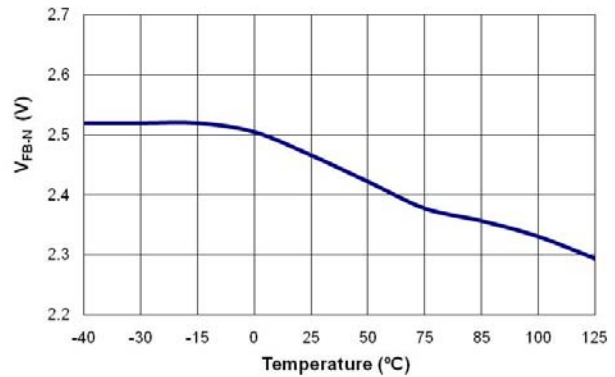
**Figure 8. Operating Current (I<sub>DD-OP2</sub>) vs. Temperature**



**Figure 9. V<sub>DD</sub> Over-Voltage Protection (V<sub>DD-OVP</sub>) vs. Temperature**



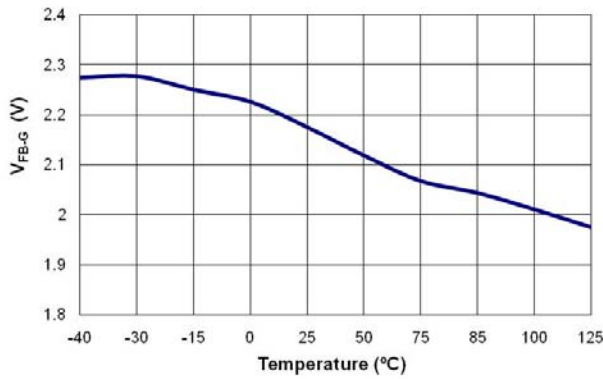
**Figure 10. Center Frequency (f<sub>OSC</sub>) vs. Temperature**



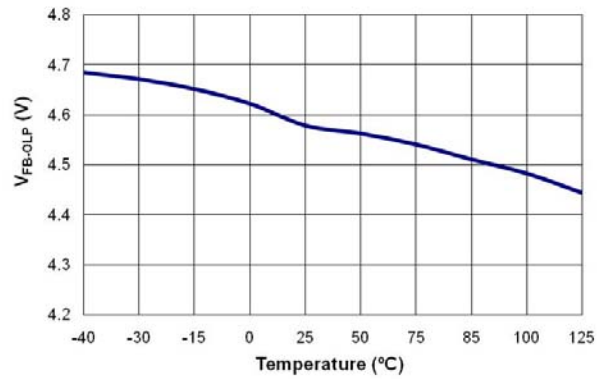
**Figure 11. FB Threshold Voltage for Frequency Reduction (V<sub>FB-N</sub>) vs. Temperature**



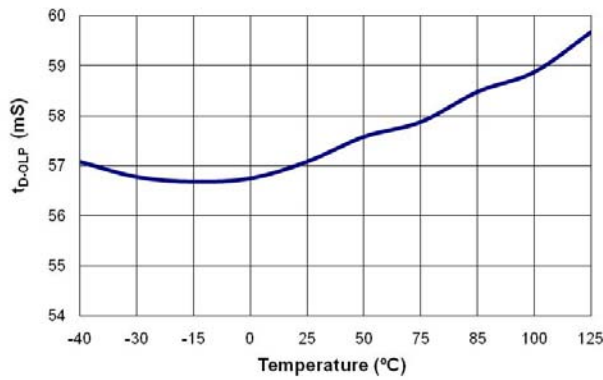
**Typical Performance Characteristics** (Continued)



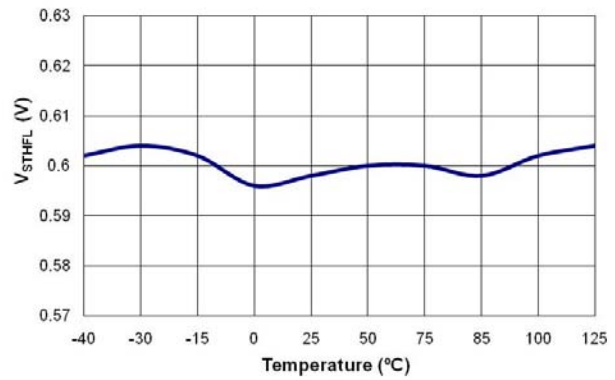
**Figure 12. FB Voltage at  $f_{OSC-G}$  ( $V_{FB-G}$ ) vs. Temperature**



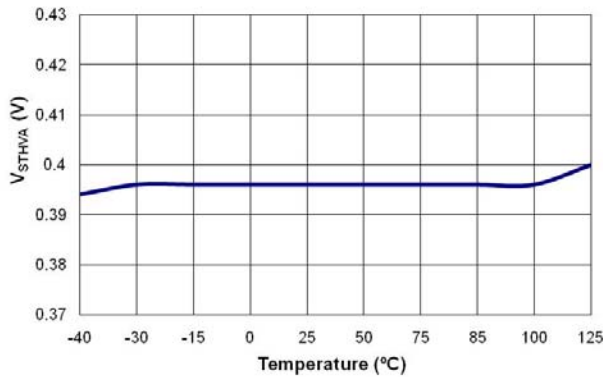
**Figure 13. Threshold Voltage for Open-Loop Protection ( $V_{FB-OLP}$ ) vs. Temperature**



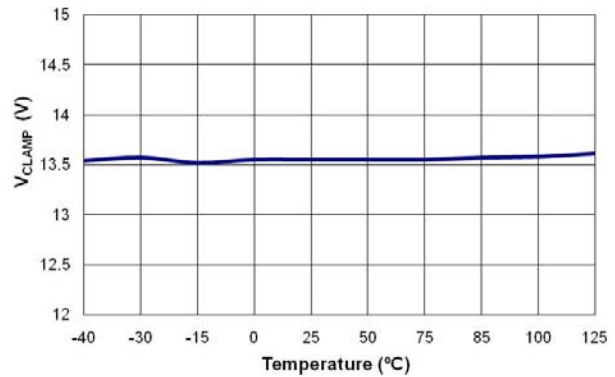
**Figure 14. Open-Loop Protection Delay ( $t_{D-OLP}$ ) vs. Temperature**



**Figure 15. Flat Threshold Voltage for Current Limit ( $V_{STHFL}$ ) vs. Temperature**

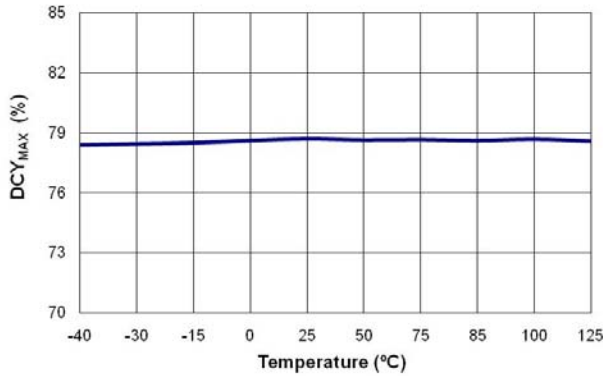


**Figure 16. Valley Threshold Voltage for Current Limit ( $V_{STHVA}$ ) vs. Temperature**

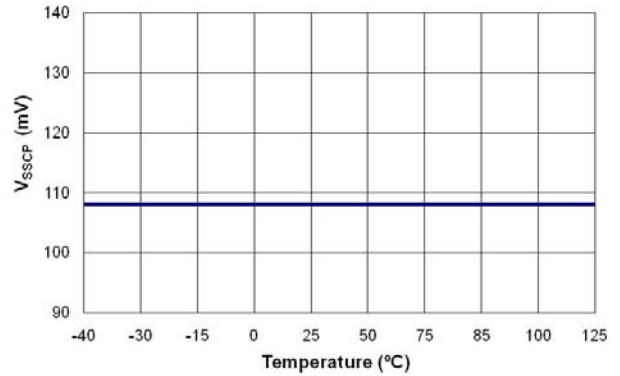


**Figure 17. GATE Output Clamping Voltage ( $V_{CLAMP}$ ) vs. Temperature**

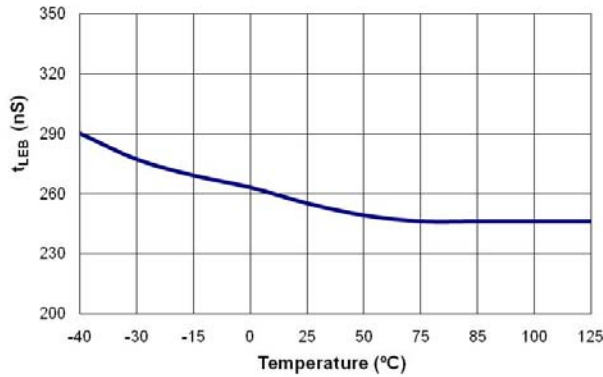
**Typical Performance Characteristics (Continued)**



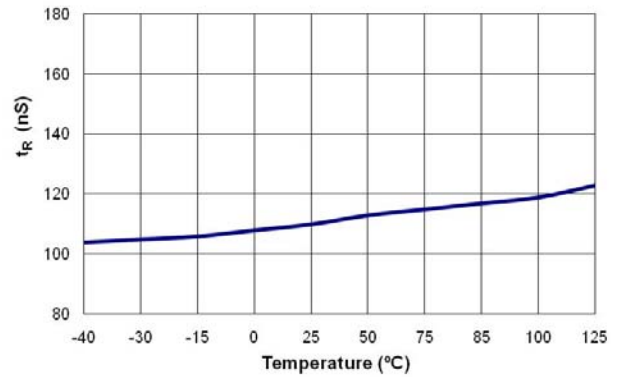
**Figure 18. Maximum Duty Cycle (DCY<sub>MAX</sub>) vs. Temperature**



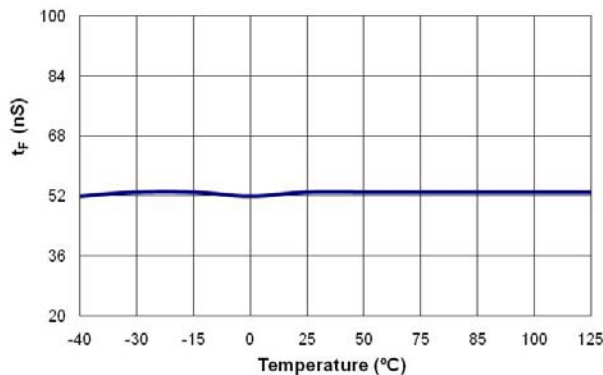
**Figure 19. Threshold Voltage for SENSE Short-Circuit Protection (V<sub>SSCP</sub>) vs. Temperature**



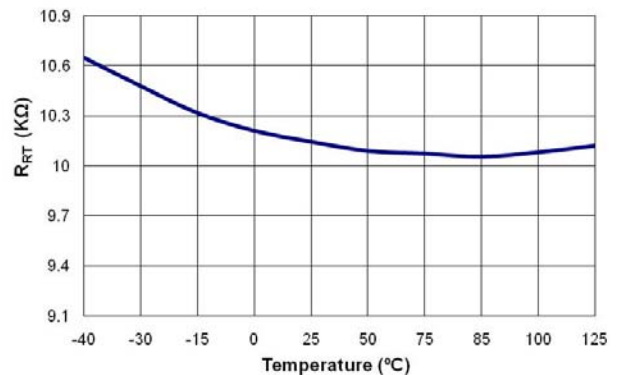
**Figure 20. Leading-Edge Blanking Time (t<sub>LEB</sub>) vs. Temperature**



**Figure 21. Rising Time (t<sub>r</sub>) vs. Temperature**



**Figure 22. Falling Time (t<sub>f</sub>) vs. Temperature**



**Figure 23. Internal Resistor from RT Pin (R<sub>RT</sub>) vs. Temperature**

## Operation Description

### Startup Operation

Figure 24 shows a typical startup circuit and transformer auxiliary winding for a typical application. Before switching operation begins, FAN6863W consumes only startup current (typically 8 $\mu$ A) and the current supplied through the startup resistor charges the V<sub>DD</sub> capacitor (C<sub>DD</sub>). When V<sub>DD</sub> reaches turn-on voltage of 16V (V<sub>DD-ON</sub>), switching begins and the current consumed increases to 2mA. Power is then supplied from the transformer auxiliary winding. The large hysteresis of V<sub>DD</sub> (7V) provides more holdup time, which allows using a small capacitor for V<sub>DD</sub>. The startup resistor is typically connected to AC line for a fast reset of latch protection.

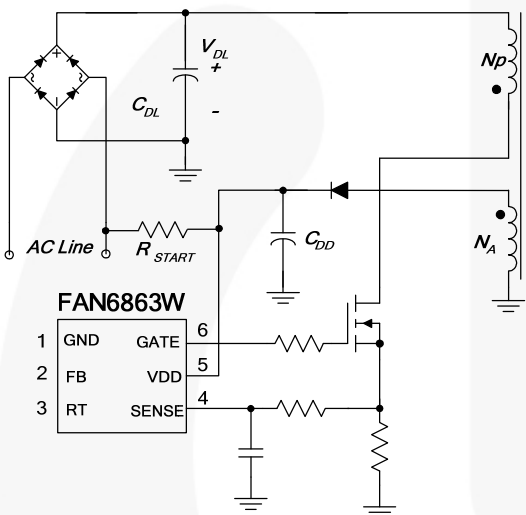


Figure 24. Startup Circuit

### Green-Mode Operation

The FAN6863W uses feedback voltage (V<sub>FB</sub>) as an indicator of the output load and modulates the PWM frequency, as shown in Figure 25, such that the switching frequency decreases as load decreases. In heavy-load conditions, the switching frequency is 65kHz. Once V<sub>FB</sub> decreases below V<sub>FB-N</sub> (2.5V), the PWM frequency starts to linearly decrease from 65kHz to 22.5kHz to reduce the switching losses. As V<sub>FB</sub> decreases below V<sub>FB-G</sub> (2.2V), the switching frequency is fixed at 22.5kHz and FAN6863W enters “deep” Green Mode, where the operating current decreases to 600 $\mu$ A (maximum), further reducing the standby power consumption. As V<sub>FB</sub> decreases below V<sub>FB-ZDC</sub> (1.6V), FAN6863W enters Burst-Mode operation. When V<sub>FB</sub> drops below V<sub>FB-ZDC</sub>, switching stops and the output voltage starts to drop, which causes the feedback voltage to rise. Once V<sub>FB</sub> rises above V<sub>FB-ZDC</sub>, switching resumes. Burst Mode alternately enables and disables switching, thereby reducing switching loss in Standby Mode, as shown in Figure 26.

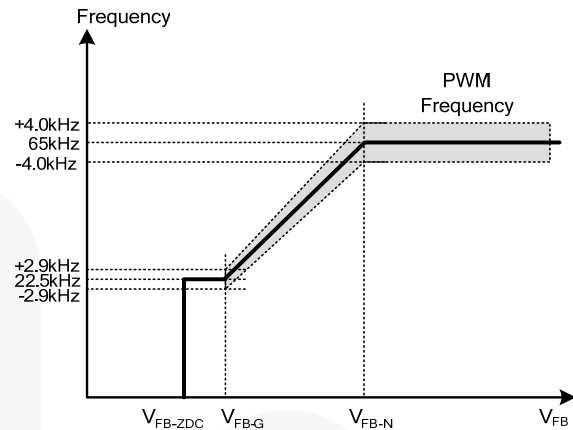


Figure 25. PWM Frequency

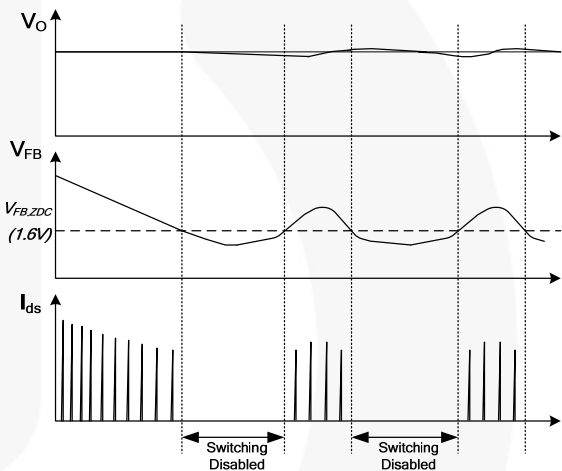


Figure 26. Burst-Mode Operation

### Frequency Hopping

EMI reduction is accomplished by frequency hopping, which spreads the energy over a wider frequency range than the bandwidth measured by the EMI test equipment. An internal frequency hopping circuit changes the switching frequency between 61.0kHz and 69.0kHz with a period of 4.4ms, as shown in Figure 27. It covers the whole frequency range in hopping function and shrinks the period with operation frequency proportionally.

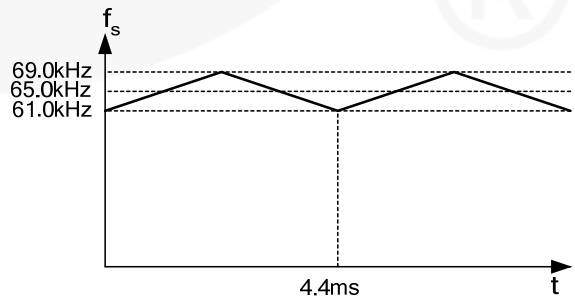


Figure 27. Frequency Hopping

## Protections

Self-protective functions include  $V_{DD}$  Over-Voltage Protection (OVP), Open-Loop / Overload Protection (OLP), Over-Current Protection (OCP), Short-Circuit Protection (SCP), SENSE pin Short-Circuit Protection (SSCP), and Over-Temperature Protection (OTP). OLP, OCP, SCP, and SSCP are Auto-Restart Mode protections; OVP and OTP are Latch-Mode protections.

### Auto-Restart Mode Protection

Once a fault condition is detected, switching is terminated and the MOSFET remains off. This causes  $V_{DD}$  to fall because no more power is delivered from auxiliary winding. When  $V_{DD}$  falls to  $V_{DD-OFF}$  (7V), the protection is reset and the operating current reduces to startup current, which causes  $V_{DD}$  to rise. FAN6863W resumes normal operation when  $V_{DD}$  reaches  $V_{DD-ON}$  (16V). In this manner, the auto-restart can alternately enable and disable the switching of the MOSFET until the fault condition is eliminated (see Figure 28).

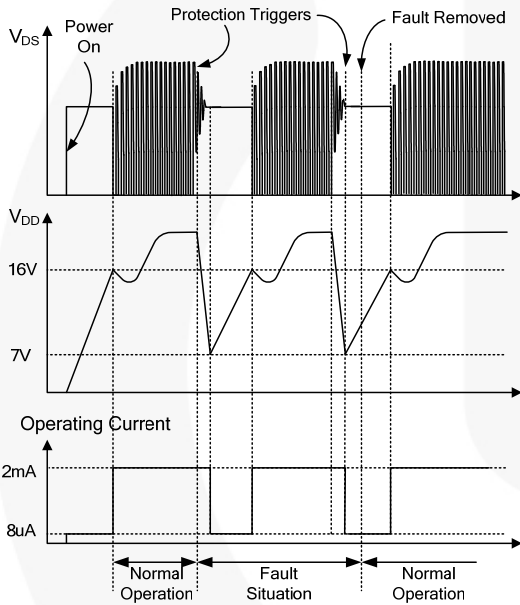


Figure 28. Auto Restart Operation

### Latch-Mode Protection

Once this protection is triggered, switching is terminated and the MOSFET remains off. The latch is reset only when  $V_{DD}$  is discharged below 4V by unplugging the AC power line.

### Over-Current Protection (OCP)

The FAN6863W over-current protection threshold is a pulse-by-pulse current limit ( $V_{LIMIT}$ ), which turns off MOSFET for the remainder of the switching cycle when the sensing voltage of MOSFET drain current reaches the threshold. The  $V_{LIMIT}$  compensates the power limit variation over universal input range and adaptively keeps the power limit substantially constant.

### Open-Loop / Overload Protection (OLP)

When the upper branch of the voltage divider for the shunt regulator (KA431 shown in Figure 29) is broken, no current flows through the photo-coupler transistor, which pulls up the feedback voltage to 5.4V.

When feedback voltage is above 4.6V for longer than 60ms, OLP is triggered. This protection is also triggered when the SMPS output drops below the nominal value for longer than 60ms due to the overload condition.

If the secondary output-short situation occurs when the feedback voltage is above 4.6V, protection time is 7ms for shorter debounce time.

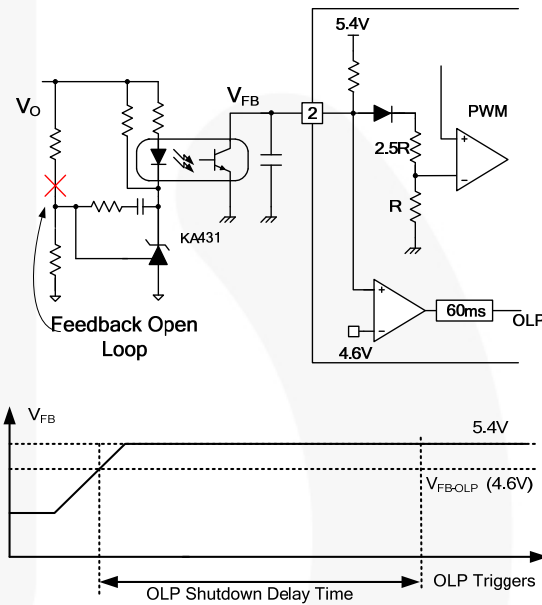


Figure 29. OLP Operation

### $V_{DD}$ Over-Voltage Protection (OVP)

$V_{DD}$  over-voltage protection prevents IC damage caused by over voltage on the  $V_{DD}$  pin. The OVP is triggered when  $V_{DD}$  reaches 22.2V. A debounce time (typically 50 $\mu$ s) prevents false triggering by switching noise.

### Over-Temperature Protection (OTP)

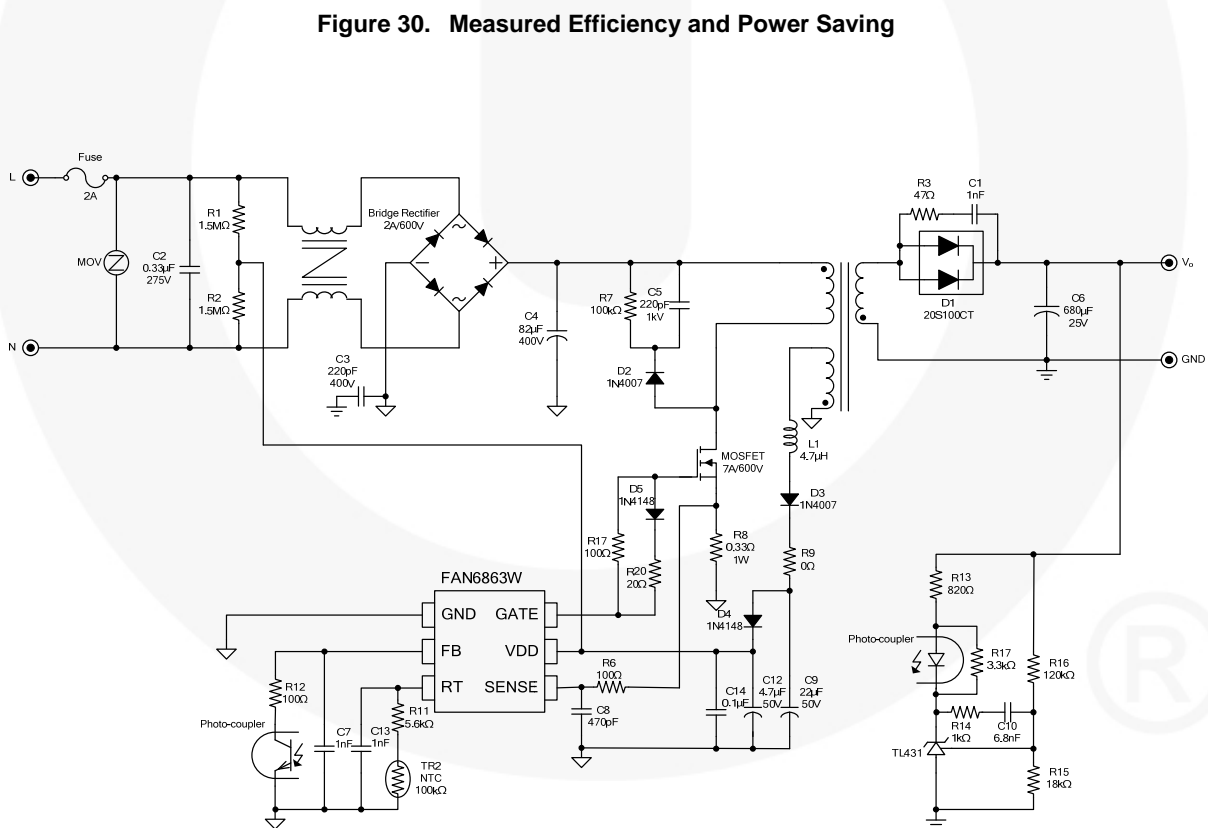
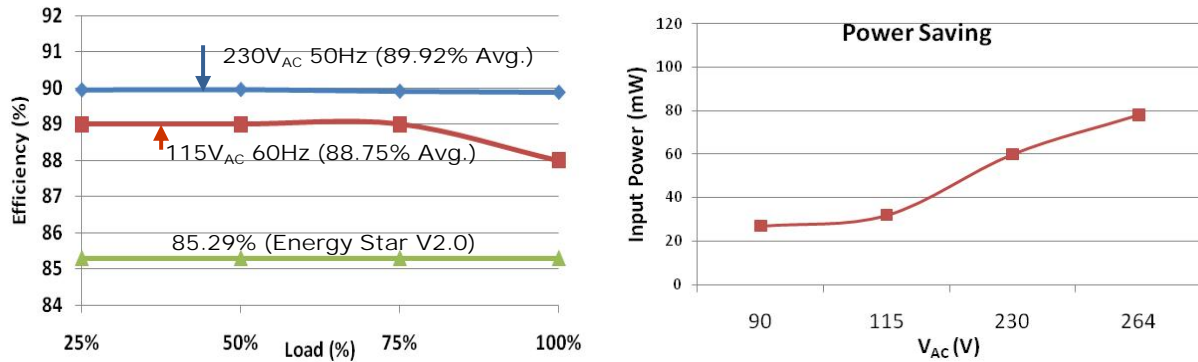
The OTP circuit is composed of current source and voltage comparators. Typically, an NTC thermistor is connected between the RT and GND pins. If the voltage of this pin drops below a threshold of 1.0V, PWM output is disabled after  $t_{DOTP}$  debounce time. If this pin voltage drops below 0.7V, it triggers the latch-off protection immediately after  $t_{DOTP2}$  debounce time.

## Typical Application Circuit (Netbook Adapter by Flyback)

Application	Fairchild Devices	Input Voltage Range	Output
Netbook Adapter	FAN6863W	90~265V <sub>AC</sub>	19V/2.1A (40W)

### Features

- High efficiency (>85.3% at full-load condition) meeting EPS regulation with enough margin
- Low standby (pin<0.1W at no-load condition)
- Soft-start time: 5ms



**Figure 31. Schematic of Typical Application Circuit**

### Transformer Specification

- Core: RM 8
- Bobbin: RM 8

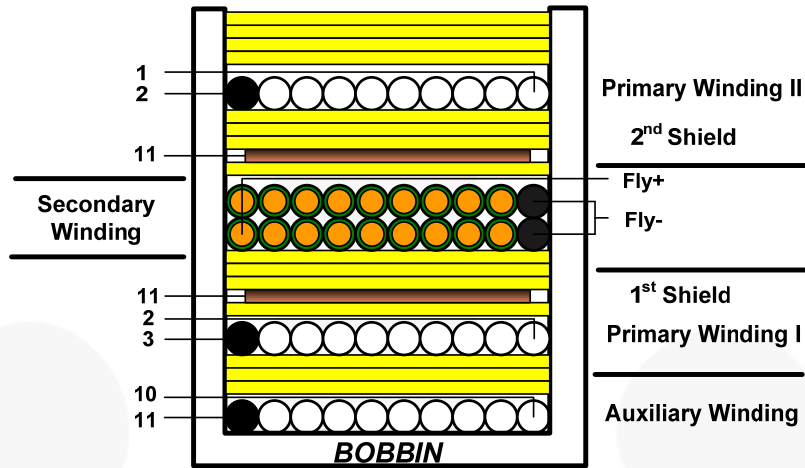


Figure 32. Transformer

NO	Terminal		Wire	Ts	Insulation	Barrier	
	S	F			Ts	Primary	Secondary
N1	11	10	0.25 • 1	9	3		
N2	3	2	0.25 • 1	33	1		
	11		COPPER SHIELD	1.2	3		
N3	Fly-	Fly+	0.5 • 2	12	1		
	11		COPPER SHIELD	1.2	3		
N4	2	1	0.25 • 1	33	4		
			CORE ROUNDING TAPE		3		

	Pin	Specification	Remark
Primary-Side Inductance	3-1	920µH ±5%	100kHz, 1V
Primary-Side Effective Leakage	3-1	15µH Maximum	Short One of the Secondary Windings

Physical Dimensions

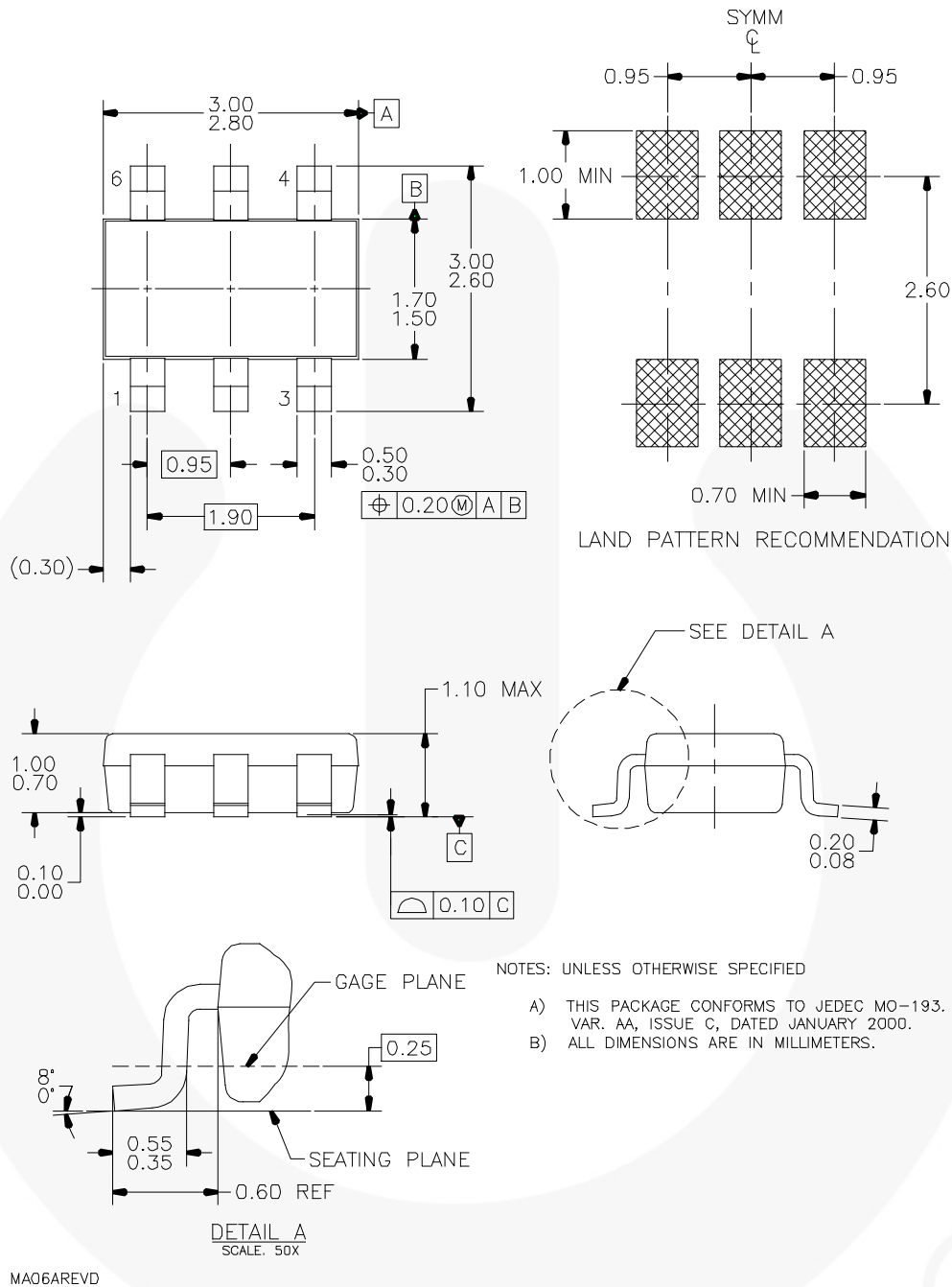


Figure 33. 6-Lead, SuperSOT™-6 JEDEC, M0-193 1.6mm Wide

Package drawings are provided as a service to customers considering Fairchild components. Drawings may change in any manner without notice. Please note the revision and/or date on the drawing and contact a Fairchild Semiconductor representative to verify or obtain the most recent revision. Package specifications do not expand the terms of Fairchild's worldwide terms and conditions, specifically the warranty therein, which covers Fairchild products.



Always visit Fairchild Semiconductor's online packaging area for the most recent package drawings:  
<http://www.fairchildsemi.com/packaging/>.





### TRADEMARKS

The following includes registered and unregistered trademarks and service marks, owned by Fairchild Semiconductor and/or its global subsidiaries, and is not intended to be an exhaustive list of all such trademarks.

2Cool™	F-PFS™	PowerTrench®	The Power Franchise®
AccuPower™	FRFET®	PowerXS™	<b>the power franchise</b>
AX-CAP™*	Global Power Resource™	Programmable Active Droop™	TinyBoost™
BitSiC™	GreenBridge™	QFET®	TinyBuck™
Build it Now™	Green FPS™	QS™	TinyCalc™
CorePLUS™	Green FPS™ e-Series™	Quiet Series™	TinyLogic™
CorePOWER™	Gmax™	RapidConfigure™	TINYOPTO™
CROSSVOLT™	GTO™	 ™	TinyPower™
CTL™	IntelliMAX™	Saving our world, 1mW/W/kW at a time™	TinyPWM™
Current Transfer Logic™	ISOPLANAR™	SignalWise™	TinyWire™
DEUXPEED®	Making Small Speakers Sound Louder and Better™	SmartMax™	TranSiC™
Dual Cool™	MegaBuck™	SMART START™	TriFault Detect™
EcoSPARK®	MICROCOUPLER™	Solutions for Your Success™	TRUECURRENT®*
EfficientMax™	MicroFET™	SPM®	µSerDes™
ESBC™	MicroPak™	STEALTH™	 SerDes™
 Fairchild®	MicroPak2™	SuperFET®	UHC®
Fairchild Semiconductor®	MillerDrive™	SuperSOT™-3	Ultra FRFET™
FACT Quiet Series™	MotionMax™	SuperSOT™-6	UniFET™
FACT®	mWSaver™	SuperSOT™-8	VCM™
FAST®	OptoHiT™	SupreMOS®	VisualMax™
FastvCore™	OPTOLOGIC®	SyncFET™	VoltagePlus™
FETBench™	OPTOPLANAR®	Sync-Lock™	XS™
FlashWriter®*		 SYSTEM GENERAL®*	
FPS™			

\* Trademarks of System General Corporation, used under license by Fairchild Semiconductor.

### DISCLAIMER

FAIRCHILD SEMICONDUCTOR RESERVES THE RIGHT TO MAKE CHANGES WITHOUT FURTHER NOTICE TO ANY PRODUCTS HEREIN TO IMPROVE RELIABILITY, FUNCTION, OR DESIGN. FAIRCHILD DOES NOT ASSUME ANY LIABILITY ARISING OUT OF THE APPLICATION OR USE OF ANY PRODUCT OR CIRCUIT DESCRIBED HEREIN; NEITHER DOES IT CONVEY ANY LICENSE UNDER ITS PATENT RIGHTS, NOR THE RIGHTS OF OTHERS. THESE SPECIFICATIONS DO NOT EXPAND THE TERMS OF FAIRCHILD'S WORLDWIDE TERMS AND CONDITIONS, SPECIFICALLY THE WARRANTY THEREIN, WHICH COVERS THESE PRODUCTS.

### LIFE SUPPORT POLICY

FAIRCHILD'S PRODUCTS ARE NOT AUTHORIZED FOR USE AS CRITICAL COMPONENTS IN LIFE SUPPORT DEVICES OR SYSTEMS WITHOUT THE EXPRESS WRITTEN APPROVAL OF FAIRCHILD SEMICONDUCTOR CORPORATION.

As used herein:

1. Life support devices or systems are devices or systems which, (a) are intended for surgical implant into the body or (b) support or sustain life, and (c) whose failure to perform when properly used in accordance with instructions for use provided in the labeling, can be reasonably expected to result in a significant injury of the user.
2. A critical component in any component of a life support, device, or system whose failure to perform can be reasonably expected to cause the failure of the life support device or system, or to affect its safety or effectiveness.

### ANTI-COUNTERFEITING POLICY

Fairchild Semiconductor Corporation's Anti-Counterfeiting Policy. Fairchild's Anti-Counterfeiting Policy is also stated on our external website, [www.fairchildsemi.com](http://www.fairchildsemi.com), under Sales Support.

Counterfeiting of semiconductor parts is a growing problem in the industry. All manufacturers of semiconductor products are experiencing counterfeiting of their parts. Customers who inadvertently purchase counterfeit parts experience many problems such as loss of brand reputation, substandard performance, failed applications, and increased cost of production and manufacturing delays. Fairchild is taking strong measures to protect ourselves and our customers from the proliferation of counterfeit parts. Fairchild strongly encourages customers to purchase Fairchild parts either directly from Fairchild or from Authorized Fairchild Distributors who are listed by country on our web page cited above. Products customers buy either from Fairchild directly or from Authorized Fairchild Distributors are genuine parts, have full traceability, meet Fairchild's quality standards for handling and storage and provide access to Fairchild's full range of up-to-date technical and product information. Fairchild and our Authorized Distributors will stand behind all warranties and will appropriately address any warranty issues that may arise. Fairchild will not provide any warranty coverage or other assistance for parts bought from Unauthorized Sources. Fairchild is committed to combat this global problem and encourage our customers to do their part in stopping this practice by buying direct or from authorized distributors.

### PRODUCT STATUS DEFINITIONS

#### Definition of Terms

Datasheet Identification	Product Status	Definition
Advance Information	Formative / In Design	Datasheet contains the design specifications for product development. Specifications may change in any manner without notice.
Preliminary	First Production	Datasheet contains preliminary data; supplementary data will be published at a later date. Fairchild Semiconductor reserves the right to make changes at any time without notice to improve design.
No Identification Needed	Full Production	Datasheet contains final specifications. Fairchild Semiconductor reserves the right to make changes at any time without notice to improve the design.
Obsolete	Not In Production	Datasheet contains specifications on a product that is discontinued by Fairchild Semiconductor. The datasheet is for reference information only.

Rev. I62