

# CD54/74HC/HCT160, CD54/74HC/HCT161 CD54/74HC/HCT162, CD54/74HC/HCT163

## High-Speed CMOS Logic

### FUNCTIONAL DIAGRAM

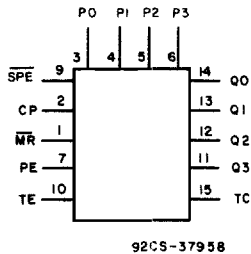

### Pre-settable Counters

CD54/74HC/HCT160 BCD Decade Counter, Asynchronous Reset  
 CD54/74HC/HCT161 4-Bit Binary Counter, Asynchronous Reset  
 CD54/74HC/HCT162 BCD Decade Counter, Synchronous Reset  
 CD54/74HC/HCT163 4-Bit Binary Counter, Synchronous Reset

#### Type Features:

- Synchronous Counting and Loading
- Two Count Enable Inputs for n-Bit Cascading
- Asynchronous Reset (CD54/74HC/HCT160, 161)
- Synchronous Reset (CD54/74HC/HCT162, 163)
- Look-Ahead Carry for High-Speed Counting

The RCA-CD54/74HC/HCT160, 161, 162, and 163 devices are pre-settable synchronous counters that feature look-ahead carry logic for use in high-speed counting applications. The CD54/74HC/HCT160 and 161 are asynchronous reset decade and binary counters, respectively; the CD54/74HC/HCT162 and 163 devices are decade and binary counters, respectively and are reset synchronously with the clock. Counting and parallel presetting are both accomplished synchronously with the negative-to-positive transition of the clock.

A low level on the synchronous parallel enable input,  $\overline{SPE}$ , disables the counting operation and allows data at the P0 to P3 inputs to be loaded into the counter (provided that the setup and hold requirements for  $\overline{SPE}$  are met).

All counters are reset with a low level on the Master Reset input,  $\overline{MR}$ . In the CD54/74HC/HCT162 and 163 counters (synchronous reset types), the requirements for setup and hold time with respect to the clock must be met.

Two count enables, PE and TE, in each counter are provided for n-bit cascading. In all counters reset action occurs regardless of the level of the  $\overline{SPE}$ , PE and TE inputs (and the clock input, CP, in the CD54/74HC/HCT160 and 161 types).

If a decade counter is preset to an illegal state or assumes an illegal state when power is applied, it will return to the normal sequence in one count as shown in state diagram.

The look-ahead carry feature simplifies serial cascading of the counters. Both count enable inputs (PE and TE) must be high to count. The TE input is gated with the Q outputs of all four stages so that at the maximum count the terminal count (TC) output goes high for one clock period. This TC pulse is used to enable the next cascaded stage.

The CD54HC160 through 163 and the CD54HCT160 through 163 are supplied in 16-lead hermetic dual-in-line ceramic packages (F suffix). The CD74HC160 through 163 and the CD74HCT160 through 163 are supplied in 16-lead dual-in-line plastic packages (E suffix), and in 16-lead dual-in-line surface mount plastic packages (M suffix). All types are also supplied in chip form (H suffix).

#### Family Features:

- Fanout (Over Temperature Range):  
Standard Outputs - 10 LSTTL Loads  
Bus Driver Outputs - 15 LSTTL Loads
- Wide Operating Temperature Range:  
CD74HC/HCT: -40 to +85° C
- Balanced Propagation Delay and Transition Times
- Significant Power Reduction Compared to LSTTL Logic ICs
- Alternate Source is Philips/Signetics
- CD54HC/CD74HC Types:  
2 to 6 V Operation  
High Noise Immunity:  $N_{IL} = 30\%$ ,  $N_{IH} = 30\%$  of  $V_{CC}$ , @  $V_{CC} = 5 V$
- CD54HCT/CD74HCT Types:  
4.5 to 5.5 V Operation  
Direct LSTTL Input Logic Compatibility  
 $V_{IL} = 0.8 V \text{ Max.}$ ,  $V_{IH} = 2 V \text{ Min.}$   
CMOS Input Compatibility  
 $I_i \leq 1 \mu A$  @  $V_{OL}$ ,  $V_{OH}$

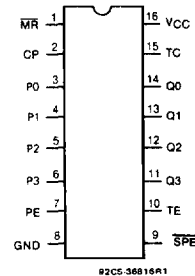

#### TERMINAL ASSIGNMENT



# CD54/74HC/HCT160, CD54/74HC/HCT161 CD54/74HC/HCT162, CD54/74HC/HCT163

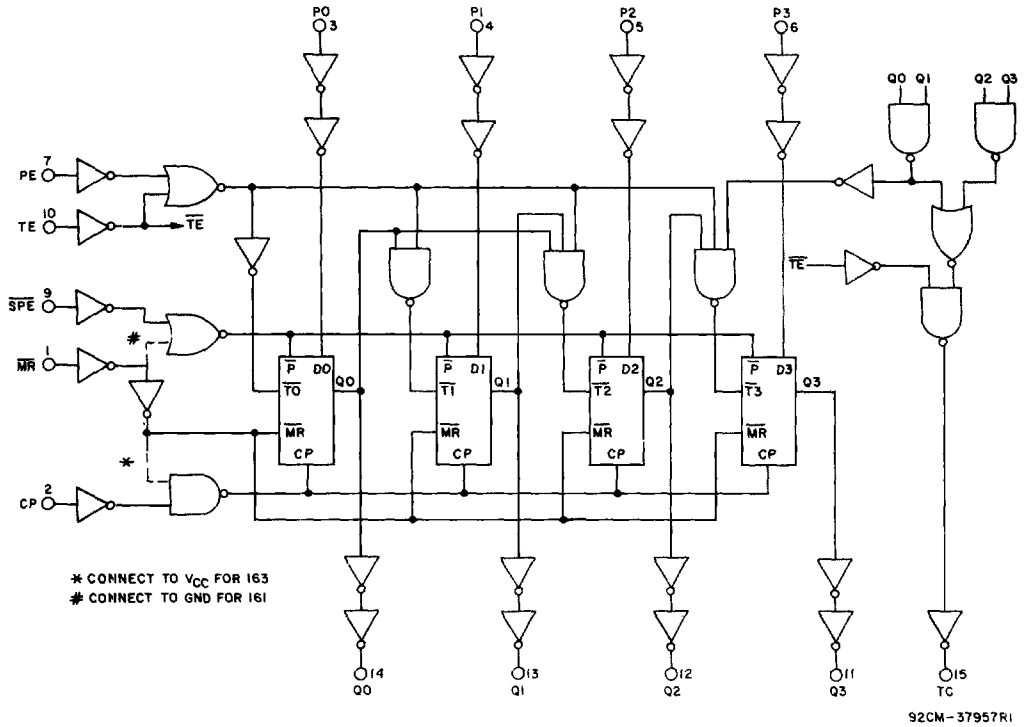





Fig. 2 - Logic diagram for the CD54/74HC/HCT161 and 163.

MODE SELECT - FUNCTION TABLE, 160, 161

OPERATING MODE	INPUTS						OUTPUTS	
	$\overline{MR}$	CP	PE	TE	$\overline{SPE}$	P <sub>n</sub>	Q <sub>n</sub>	TC
Reset (Clear)	L	X	X	X	X	X	L	L
Parallel Load	H		X	X	l	l	L	L
	H		X	X	l	h	H	(a)
Count	H		h	h	h(c)	X	count	(a)
Inhibit	H	X	l(b)	X	h(c)	X	q <sub>n</sub>	(a)
	H	X	X	l(b)	h(c)	X	q <sub>n</sub>	L

# CD54/74HC/HCT160, CD54/74HC/HCT161 CD54/74HC/HCT162, CD54/74HC/HCT163

MODE SELECT - FUNCTION TABLE, 162, 163

OPERATING MODE	INPUTS						OUTPUTS	
	$\overline{MR}$	CP	PE	TE	$\overline{SPE}$	P <sub>n</sub>	Q <sub>n</sub>	TC
Reset (Clear)	1		X	X	X	X	L	L
Parallel Load	h(f)		X	X	l	l	L	L
	h(f)		X	X	l	h	H	(d)
Count	h(f)		h	h	h(f)	X	count	(d)
Inhibit	h(f)	X	l(e)	X	h(f)	X	q <sub>n</sub>	(d)
	h(f)	X	X	l(e)	h(f)	X	q <sub>n</sub>	L

H = HIGH voltage level steady state.

L = LOW voltage level steady state.

h = HIGH voltage level one setup time prior to the LOW-to-HIGH clock transition.

l = LOW voltage level one setup time prior to the LOW-to-HIGH clock transition.

X = Don't care.

q = Lower case letters indicate the state of the referenced output prior to the LOW-to-HIGH clock transition.

 = LOW-to-HIGH clock transition.

NOTES

- (a) The TC output is HIGH when TE is HIGH and the counter is at Terminal Count (HHHH for 161 and HLLH for 160).
- (b) The HIGH-to-LOW transition of PE or TE on the 54/74161 and 54/74160 should only occur while CP is HIGH for conventional operation.
- (c) The LOW-to-HIGH transition of  $\overline{SPE}$  on the 54/74161 and 54/74160 should only occur while CP is HIGH for conventional operation.
- (d) The TC output is HIGH when TE is HIGH and the counter is at Terminal Count (HLLH for 162 and HHHH for 163).
- (e) The HIGH-to-LOW transition of PE or TE on the 54/74163 should only occur while CP is HIGH for conventional operation.
- (f) The LOW-to-HIGH transition of  $\overline{SPE}$  or  $\overline{MR}$  on the 54/74163 should only occur while CP is HIGH for conventional operation.

RECOMMENDED OPERATING CONDITIONS:

For maximum reliability, nominal operating conditions should be selected so that operation is always within the following ranges:

CHARACTERISTIC	LIMITS		UNITS
	MIN.	MAX.	
Supply-Voltage Range (For T <sub>A</sub> = Full Package Temperature Range) V <sub>CC</sub> * CD54/74HC Types CD54/74HCT Types	2 4.5	6 5.5	V V
DC Input or Output Voltage V <sub>I</sub> , V <sub>O</sub>	0	V <sub>CC</sub>	V
Operating Temperature T <sub>A</sub> : CD74 Types CD54 Types	-40 -55	+85 +125	°C °C
Input Rise and Fall Times, t <sub>r</sub> , t <sub>f</sub> at 2 V at 4.5 V at 6 V	0 0 0	1000 500 400	ns ns ns

\*Unless otherwise specified, all voltages are referenced to Ground.

# CD54/74HC/HCT160, CD54/74HC/HCT161 CD54/74HC/HCT162, CD54/74HC/HCT163

## STATIC ELECTRICAL CHARACTERISTICS

CHARACTERISTIC	CD74HC160-163/CD54HC160-163										CD74HCT160-163/CD54HCT160-163										UNITS
	TEST CONDITIONS			74HC/54HC SERIES			74HC SERIES		54HC SERIES		TEST CONDITIONS		74HCT/54HCT SERIES			74HCT SERIES		54HCT SERIES			
	V <sub>I</sub> V	I <sub>O</sub> mA	V <sub>CC</sub> V	+25°C			-40/ +85°C		-55/ +125°C		V <sub>I</sub> V	V <sub>CC</sub> V	+25°C			-40/ +85°C		-55/ +125°C			
				Min	Typ	Max	Min	Max	Min	Max			Min	Typ	Max	Min	Max	Min	Max		
High-Level Input Voltage V <sub>IH</sub>			2	1.5	—	—	1.5	—	1.5	—	—	4.5								V	
			4.5	3.15	—	—	3.15	—	3.15	—		I <sub>O</sub>	2	—	—	2	—	2	—		
			6	4.2	—	—	4.2	—	4.2	—		5.5									
Low-Level Input Voltage V <sub>IL</sub>			2	—	—	0.5	—	0.5	—	0.5	—	4.5								V	
			4.5	—	—	1.35	—	1.35	—	1.35	—	I <sub>O</sub>	—	—	0.8	—	0.8	—	0.8	—	
			6	—	—	1.8	—	1.8	—	1.8	—	5.5									
High-Level Output Voltage V <sub>OH</sub>	V <sub>IL</sub> or CMOS Loads V <sub>IH</sub>	-0.02	2	1.9	—	—	1.9	—	1.9	—	V <sub>IL</sub> or V <sub>IH</sub>									V	
			4.5	4.4	—	—	4.4	—	4.4	—		4.5	4.4	—	—	4.4	—	4.4	—		
			6	5.9	—	—	5.9	—	5.9	—											
TTL Loads	V <sub>IL</sub> or V <sub>IH</sub>										V <sub>IL</sub> or V <sub>IH</sub>									V	
			-4	4.5	3.98	—	—	3.84	—	3.7	—		4.5	3.98	—	—	3.84	—	3.7	—	
			-5.2	6	5.48	—	—	5.34	—	5.2	—										
Low-Level Output Voltage V <sub>OL</sub>	V <sub>IL</sub> or CMOS Loads V <sub>IH</sub>	0.02	2	—	—	0.1	—	0.1	—	0.1	V <sub>IL</sub> or V <sub>IH</sub>									V	
			4.5	—	—	0.1	—	0.1	—	0.1		4.5	—	—	0.1	—	0.1	—	0.1	—	
			6	—	—	0.1	—	0.1	—	0.1											
TTL Loads	V <sub>IL</sub> or V <sub>IH</sub>										V <sub>IL</sub> or V <sub>IH</sub>									V	
			4	4.5	—	—	0.26	—	0.33	—	0.4		4.5	—	—	0.26	—	0.33	—	0.4	
			5.2	6	—	—	0.26	—	0.33	—	0.4										
Input Leakage Current I <sub>I</sub>	V <sub>CC</sub> or Gnd		6	—	—	±0.1	—	±1	—	±1	Any Voltage Between V <sub>CC</sub> and Gnd	5.5	—	—	±0.1	—	±1	—	±1	μA	
Quiescent Device Current I <sub>CC</sub>	V <sub>CC</sub> or Gnd	0	6	—	—	8	—	80	—	160	V <sub>CC</sub> or Gnd	5.5	—	—	8	—	80	—	160	μA	
Quiescent Device Current per input pin: 1 unit load ΔI <sub>CC</sub> *											V <sub>CC</sub> -2.1 to 5.5	—	100	360	—	450	—	490	—	μA	

\*For dual-supply systems theoretical worst case (V<sub>I</sub> = 2.4 V, V<sub>CC</sub> = 5.5 V) specification is 1.8 mA.

**HCT Input Loading Table**

Input	Unit Loads *
P0-P3	0.25
PE	0.65
CP	1.05
$\overline{\text{MR}}$	0.8
$\overline{\text{SPE}}$	0.5
TE	1.05

\*Unit load is ΔI<sub>CC</sub> limit specified in Static Characteristic Chart, e.g., 360 μA max. @ 25°C.

# CD54/74HC/HCT160, CD54/74HC/HCT161 CD54/74HC/HCT162, CD54/74HC/HCT163

SWITCHING CHARACTERISTICS (V<sub>CC</sub> = 5 V, T<sub>A</sub> = 25° C, Input t<sub>r</sub>, t<sub>f</sub> = 6 ns)

CHARACTERISTIC	SYMBOL	CL (pF)	TYPICAL		UNITS
			54/74HC	54/74HCT	
Propagation Delay CP to TC	t <sub>PHL</sub>	15	15	18	ns
CP to Qn		15	15	16	ns
TE to TC		15	9	13	ns
MR to Qn (160, 161)	t <sub>PHL</sub>	15	18	21	ns
Power Dissipation Capacitance *	C <sub>PD</sub>	—	60	63	pF

\* CPD is used to determine the dynamic power consumption, per package.

P<sub>D</sub> = C<sub>PD</sub> V<sub>CC</sub><sup>2</sup>f<sub>i</sub> + Σ (C<sub>L</sub> V<sub>CC</sub><sup>2</sup>f<sub>o</sub>) where: f<sub>i</sub> = input frequency. f<sub>o</sub> = output frequency.

C<sub>L</sub> = output load capacitance. V<sub>CC</sub> = supply voltage.

## PREREQUISITE FOR SWITCHING FUNCTION

CHARACTERISTIC	TEST CONDITIONS	LIMITS												UNITS
		25° C				-40° C to +85° C				-55° C to +125° C				
		HC		HCT		74HC		74HCT		54HC		54HCT		
V <sub>CC</sub> V	Min.	Max.	Min.	Max.	Min.	Max.	Min.	Max.	Min.	Max.	Min.	Max.		
Max. CP Freq. * f <sub>MAX</sub>	2	6	—	—	—	5	—	—	—	4	—	—	—	MHz
	4.5	30	—	30	—	24	—	24	—	20	—	20	—	
	6	35	—	—	—	28	—	—	—	24	—	—	—	
CP Width (Low) t <sub>w(L)</sub>	2	80	—	—	—	100	—	—	—	120	—	—	—	ns
	4.5	16	—	16	—	20	—	20	—	24	—	24	—	
	6	14	—	—	—	17	—	—	—	20	—	—	—	
MR Pulse Width 160, 161 t <sub>w</sub>	2	100	—	—	—	125	—	—	—	150	—	—	—	ns
	4.5	20	—	20	—	25	—	25	—	30	—	30	—	
	6	17	—	—	—	21	—	—	—	26	—	—	—	
Setup Time P <sub>n</sub> to CP t <sub>su</sub>	2	60	—	—	—	75	—	—	—	90	—	—	—	ns
	4.5	12	—	10	—	15	—	13	—	18	—	15	—	
	6	10	—	—	—	13	—	—	—	15	—	—	—	
Setup Time PE or TE to CP t <sub>su</sub>	2	50	—	—	—	65	—	—	—	75	—	—	—	ns
	4.5	10	—	13	—	13	—	16	—	15	—	20	—	
	6	9	—	—	—	11	—	—	—	13	—	—	—	
Setup Time SP <sub>E</sub> to CP t <sub>su</sub>	2	60	—	—	—	75	—	—	—	90	—	—	—	ns
	4.5	12	—	12	—	15	—	15	—	18	—	18	—	
	6	10	—	—	—	13	—	—	—	15	—	—	—	
Setup Time MR to CP (162, 163) t <sub>su</sub>	2	65	—	—	—	80	—	—	—	100	—	—	—	ns
	4.5	13	—	13	—	16	—	16	—	20	—	20	—	
	6	11	—	—	—	14	—	—	—	17	—	—	—	
Hold Time P <sub>n</sub> to CP t <sub>H</sub>	2	3	—	—	—	3	—	—	—	3	—	—	—	ns
	4.5	3	—	5	—	3	—	5	—	3	—	5	—	
	6	3	—	—	—	3	—	—	—	3	—	—	—	
Hold Time TE or PE to CP t <sub>H</sub>	2	0	—	—	—	0	—	—	—	0	—	—	—	ns
	4.5	0	—	3	—	0	—	3	—	0	—	3	—	
	6	0	—	—	—	0	—	—	—	0	—	—	—	
Hold Time 160, 162 t <sub>H</sub> SP <sub>E</sub> to CP	2	3	—	—	—	3	—	—	—	3	—	—	—	ns
	4.5	3	—	3	—	3	—	3	—	3	—	3	—	
	6	3	—	—	—	3	—	—	—	3	—	—	—	
Hold Time 161, 163 t <sub>H</sub>	2	0	—	—	—	0	—	—	—	0	—	—	—	ns
	4.5	0	—	3	—	0	—	3	—	0	—	3	—	
	6	0	—	—	—	0	—	—	—	0	—	—	—	
Recovery Time 160 t <sub>REC</sub> MR to CP 161	2	75	—	—	—	95	—	—	—	110	—	—	—	ns
	4.5	15	—	15	—	19	—	19	—	22	—	22	—	
	6	13	—	—	—	16	—	—	—	19	—	—	—	

\* Applies to non-cascaded operation only. With cascaded counters clock to terminal count propagation delays, count enables (PE or TE)-to-clock set-up times, and count enables (PE or TE)-to-clock hold times determine max. clock frequency. For example with these HC devices:

$$f_{\text{max}}(\text{CP}) = \frac{1}{\text{CP-to-TC prop. delay} + \text{TE-to-CP setup} + \text{TE-to-CP Hold}} = \frac{1}{37 + 10 + 0} \approx 21 \text{ MHz (min.)}$$



# CD54/74HC/HCT160, CD54/74HC/HCT161 CD54/74HC/HCT162, CD54/74HC/HCT163

Transition times, propagation delay times, setup, hold, and recovery times.

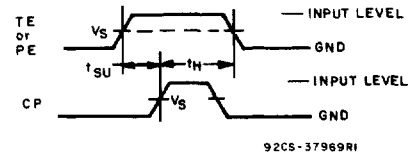
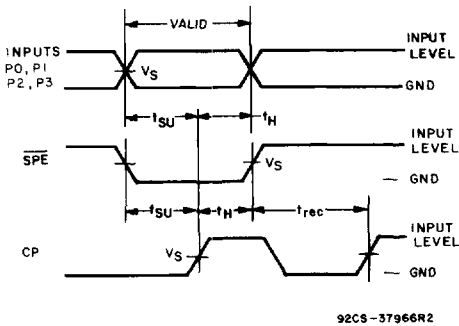
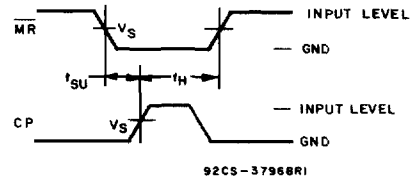
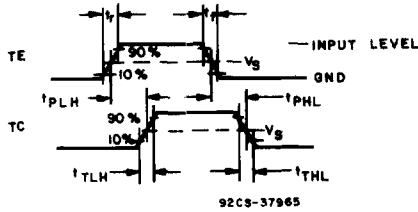
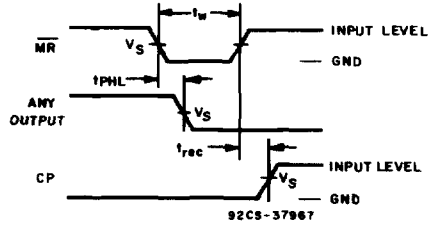
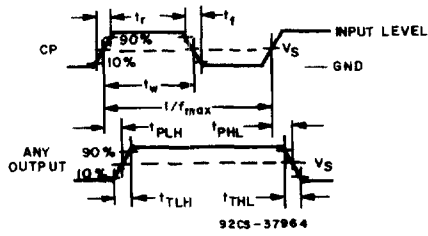

	CD54/74HC	CD54/74HCT
Input Level	$V_{CC}$	3 V
$V_S$	$0.5 V_{CC}$	1.3 V



# CD54/74HC/HCT160, CD54/74HC/HCT161 CD54/74HC/HCT162, CD54/74HC/HCT163

Timing diagrams for the CD54/74HC/HCT160 and 162.

Sequence illustrated in waveforms

1. Reset outputs to zero.
2. Preset to BCD seven.
3. Count to eight, nine, zero, one, two, and three.
4. Inhibit.

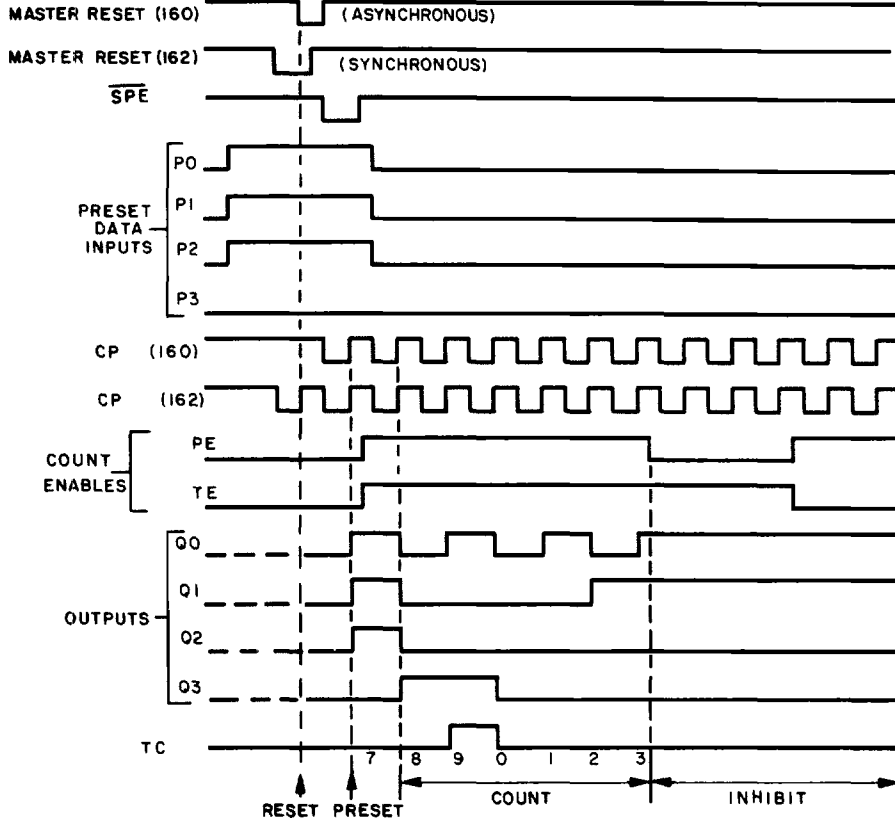

92CM-37963RI

# CD54/74HC/HCT160, CD54/74HC/HCT161 CD54/74HC/HCT162, CD54/74HC/HCT163

Timing diagrams for the CD54/74HC/HCT161 and 163.

Sequence illustrated in waveforms

1. Reset outputs to zero.
2. Preset to binary twelve.
3. Count to thirteen, fourteen, fifteen, zero, one, and two.
4. Inhibit.

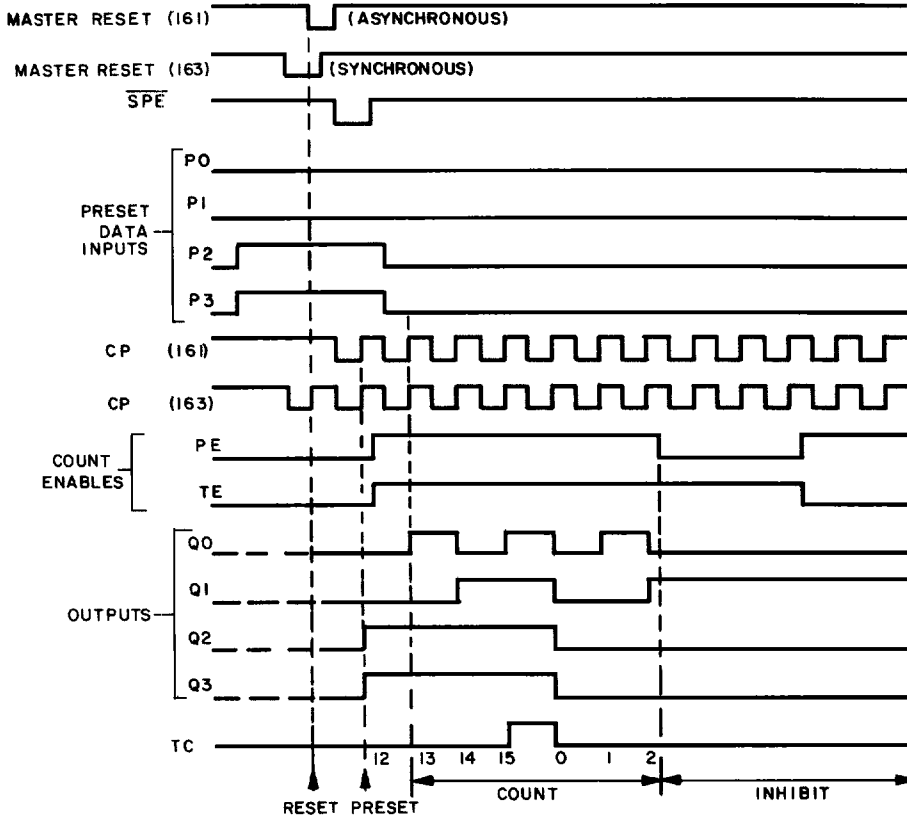

92CM-37962