

AOD480
30V N-Channel MOSFET
General Description

The AOD480 uses advanced trench technology and design to provide excellent $R_{DS(ON)}$ with low gate charge. This device is suitable for use in PWM, load switching and general purpose applications.

Features

V_{DS} (V) = 30V
 I_D = 25A (V_{GS} = 10V)
 $R_{DS(ON)}$ <23 m Ω (V_{GS} = 10V)
 $R_{DS(ON)}$ <33 m Ω (V_{GS} = 4.5V)

100% UIS Tested
 100% Rg Tested

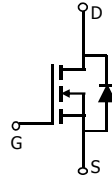
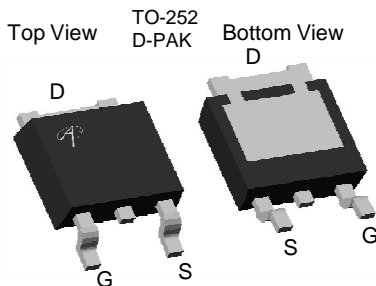
Absolute Maximum Ratings $T_A=25^\circ\text{C}$ unless otherwise noted

Parameter	Symbol	Maximum	Units
Drain-Source Voltage	V_{DS}	30	V
Gate-Source Voltage	V_{GS}	± 20	V
Continuous Drain Current ^G	I_D	$T_C=25^\circ\text{C}$	25
		$T_C=100^\circ\text{C}$	18
Pulsed Drain Current ^C	I_{DM}	64	A
Avalanche Current ^C	I_{AR}	12	A
Repetitive avalanche energy $L=0.1\text{mH}$ ^C	E_{AR}	7	mJ
Power Dissipation ^B	P_D	$T_C=25^\circ\text{C}$	21
		$T_C=100^\circ\text{C}$	11
Power Dissipation ^A	P_{DSM}	$T_A=25^\circ\text{C}$	2.5
		$T_A=70^\circ\text{C}$	1.6
Junction and Storage Temperature Range	T_J, T_{STG}	-55 to 175	$^\circ\text{C}$

Thermal Characteristics

Parameter	Symbol	Typ	Max	Units
Maximum Junction-to-Ambient ^A	$R_{\theta JA}$	16.7	25	$^\circ\text{C/W}$
Maximum Junction-to-Ambient ^A				
Maximum Junction-to-Case ^B	$R_{\theta JC}$	4.5	7	$^\circ\text{C/W}$

Electrical Characteristics ($T_J=25^\circ\text{C}$ unless otherwise noted)

Symbol	Parameter	Conditions	Min	Typ	Max	Units
STATIC PARAMETERS						
BV_{DSS}	Drain-Source Breakdown Voltage	$I_D=250\mu\text{A}, V_{GS}=0\text{V}$	30			V
I_{DSS}	Zero Gate Voltage Drain Current	$V_{DS}=24\text{V}, V_{GS}=0\text{V}$ $T_J=55^\circ\text{C}$		0.004	1	μA
I_{GSS}	Gate-Body leakage current	$V_{DS}=0\text{V}, V_{GS}=\pm 20\text{V}$			100	nA
$V_{GS(th)}$	Gate Threshold Voltage	$V_{DS}=V_{GS}, I_D=250\mu\text{A}$	1.5	2.1	2.6	V
$I_{D(ON)}$	On state drain current	$V_{GS}=10\text{V}, V_{DS}=5\text{V}$	64			A
$R_{DS(ON)}$	Static Drain-Source On-Resistance	$V_{GS}=10\text{V}, I_D=20\text{A}$ $T_J=125^\circ\text{C}$		18.5	23	$\text{m}\Omega$
		$V_{GS}=4.5\text{V}, I_D=8\text{A}$		25.4	33	$\text{m}\Omega$
g_{FS}	Forward Transconductance	$V_{DS}=5\text{V}, I_D=20\text{A}$		20		S
V_{SD}	Diode Forward Voltage	$I_S=1\text{A}, V_{GS}=0\text{V}$		0.75	1	V
I_S	Maximum Body-Diode Continuous Current				3.2	A
DYNAMIC PARAMETERS						
C_{iss}	Input Capacitance	$V_{GS}=0\text{V}, V_{DS}=15\text{V}, f=1\text{MHz}$		373	448	pF
C_{oss}	Output Capacitance			67		pF
C_{rss}	Reverse Transfer Capacitance			41		pF
R_g	Gate resistance	$V_{GS}=0\text{V}, V_{DS}=0\text{V}, f=1\text{MHz}$		2	2.8	Ω
SWITCHING PARAMETERS						
$Q_g(10\text{V})$	Total Gate Charge	$V_{GS}=10\text{V}, V_{DS}=15\text{V}, I_D=20\text{A}$	5.7	7.1	8.6	nC
$Q_g(4.5\text{V})$	Total Gate Charge		2.7	3.5	4.2	nC
Q_{gs}	Gate Source Charge			1.2		nC
Q_{gd}	Gate Drain Charge			1.6		nC
$t_{D(on)}$	Turn-On Delay Time	$V_{GS}=10\text{V}, V_{DS}=15\text{V}, R_L=0.75\Omega,$ $R_{GEN}=3\Omega$		4.3		ns
t_r	Turn-On Rise Time			2.8		ns
$t_{D(off)}$	Turn-Off Delay Time			15.8		ns
t_f	Turn-Off Fall Time			3		ns
t_{rr}	Body Diode Reverse Recovery Time	$I_F=20\text{A}, di/dt=100\text{A}/\mu\text{s}$	8.4	10.5	12.6	ns
Q_{rr}	Body Diode Reverse Recovery Charge	$I_F=20\text{A}, di/dt=100\text{A}/\mu\text{s}$	3.6	4.5	5.4	nC

A: The value of $R_{\theta JA}$ is measured with the device mounted on 1in² FR-4 board with 2oz. Copper, in a still air environment with $T_A=25^\circ\text{C}$. The Power dissipation P_{DSM} is based on $R_{\theta JA}$ and the maximum allowed junction temperature of 150°C . The value in any given application depends on the user's specific board design, and the maximum temperature of 175°C may be used if the PCB allows it.

B: The power dissipation P_D is based on $T_{J(MAX)}=175^\circ\text{C}$, using junction-to-case thermal impedance, and is more useful in setting the upper dissipation limit for cases where additional heatsinking is used.

C: Repetitive rating, pulse width limited by junction temperature $T_{J(MAX)}=175^\circ\text{C}$.

D: The $R_{\theta JA}$ is the sum of the thermal impedance from junction to case $R_{\theta JC}$ and case to ambient.

E: The static characteristics in Figures 1 to 6 are obtained using $<300\mu\text{s}$ pulses, duty cycle 0.5% max.

F: These curves are based on the junction-to-case thermal impedance which is measured with the device mounted to a large heatsink, assuming a maximum junction temperature of $T_{J(MAX)}=175^\circ\text{C}$.

G: The maximum current is limited by package.

H: These tests are performed with the device mounted on 1 in 2 FR-4 board with 2oz. Copper, in a still air environment with $T_A=25^\circ\text{C}$. The SOA curve provides a single pulse rating.

*This device is guaranteed green after data code 8X11 (Sep 1ST 2008).

Rev3: May. 2011

THIS PRODUCT HAS BEEN DESIGNED AND QUALIFIED FOR THE CONSUMER MARKET. APPLICATIONS OR USES AS CRITICAL COMPONENTS IN LIFE SUPPORT DEVICES OR SYSTEMS ARE NOT AUTHORIZED. AOS DOES NOT ASSUME ANY LIABILITY ARISING OUT OF SUCH APPLICATIONS OR USES OF ITS PRODUCTS. AOS RESERVES THE RIGHT TO IMPROVE PRODUCT DESIGN, FUNCTIONS AND RELIABILITY WITHOUT NOTICE.

TYPICAL ELECTRICAL AND THERMAL CHARACTERISTICS

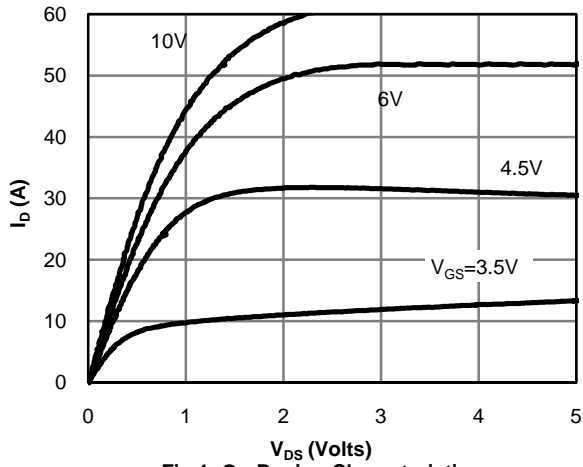

Fig 1: On-Region Characteristics

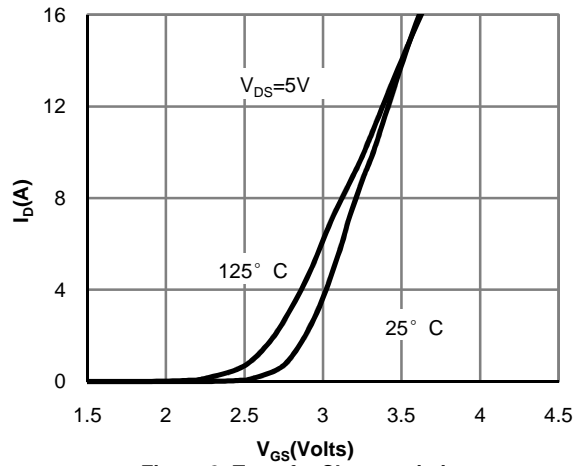

Figure 2: Transfer Characteristics

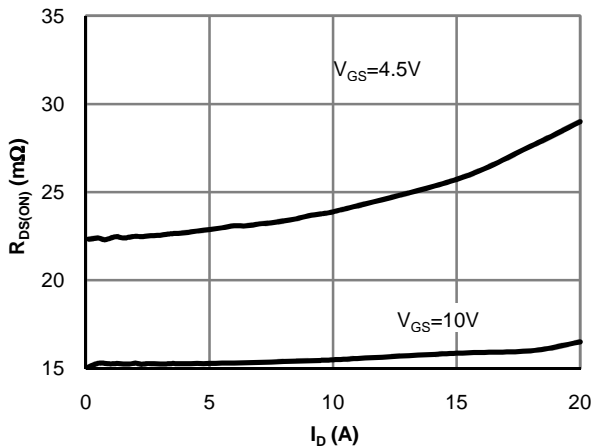

Figure 3: On-Resistance vs. Drain Current and Gate Voltage

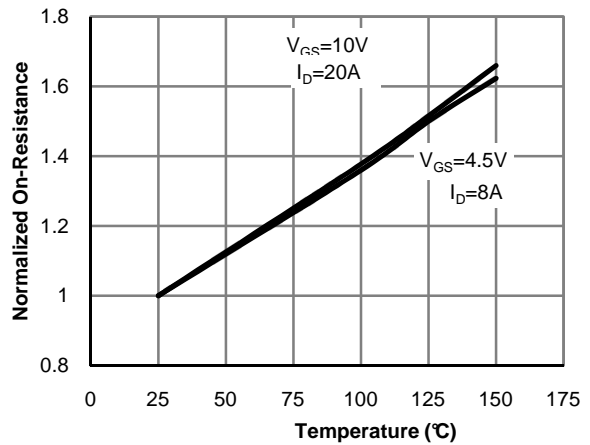

Figure 4: On-Resistance vs. Junction Temperature

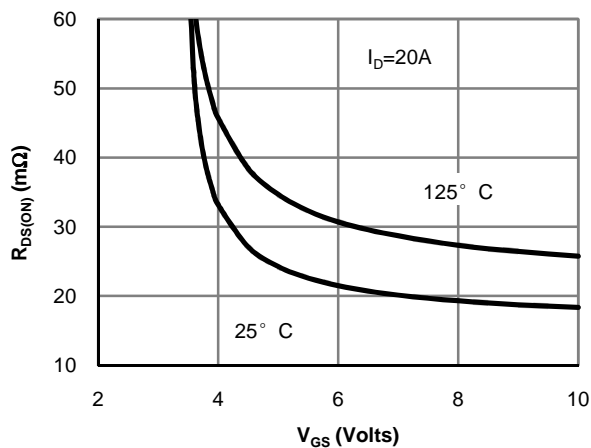

Figure 5: On-Resistance vs. Gate-Source Voltage

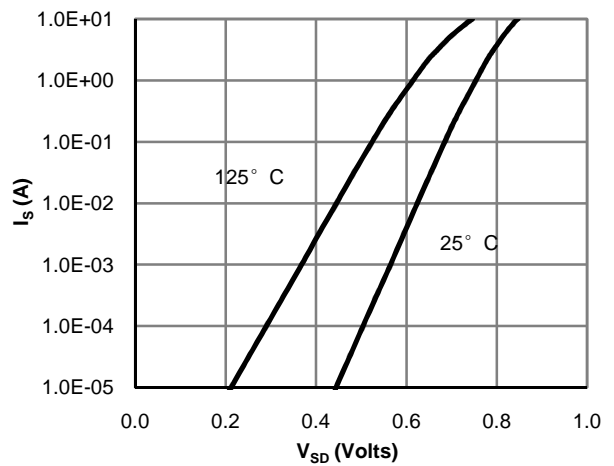

Figure 6: Body-Diode Characteristics

TYPICAL ELECTRICAL AND THERMAL CHARACTERISTICS

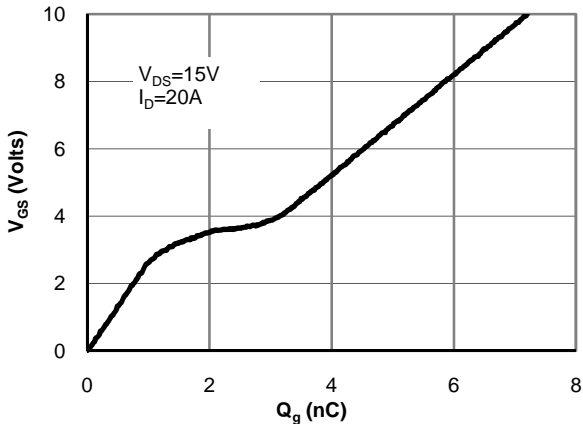

Figure 7: Gate-Charge Characteristics

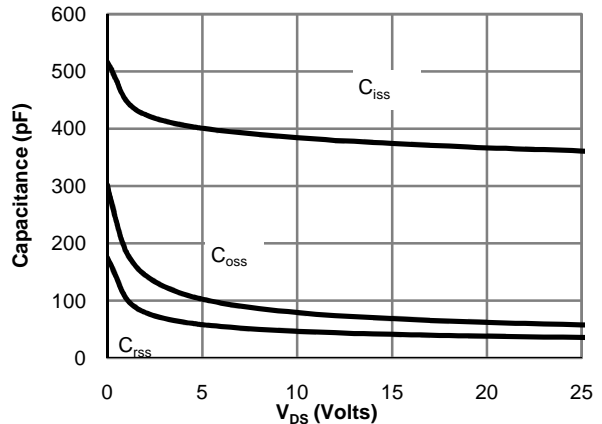

Figure 8: Capacitance Characteristics

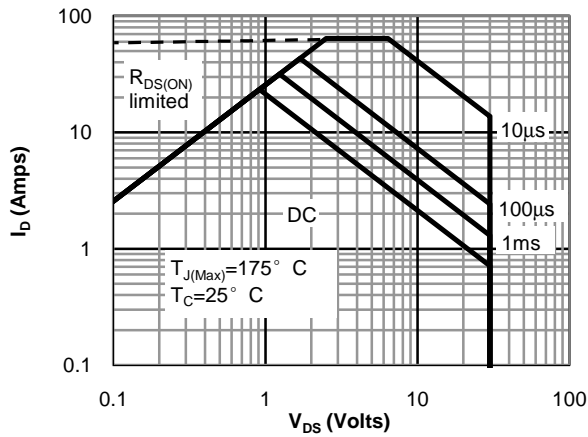

Figure 9: Maximum Forward Biased Safe Operating Area (Note F)

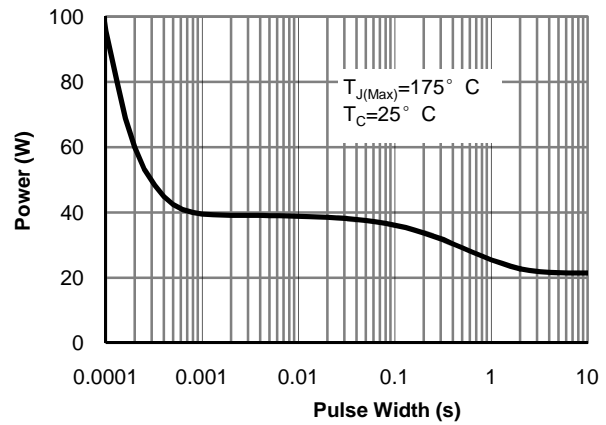

Figure 10: Single Pulse Power Rating Junction-to-Case (Note F)

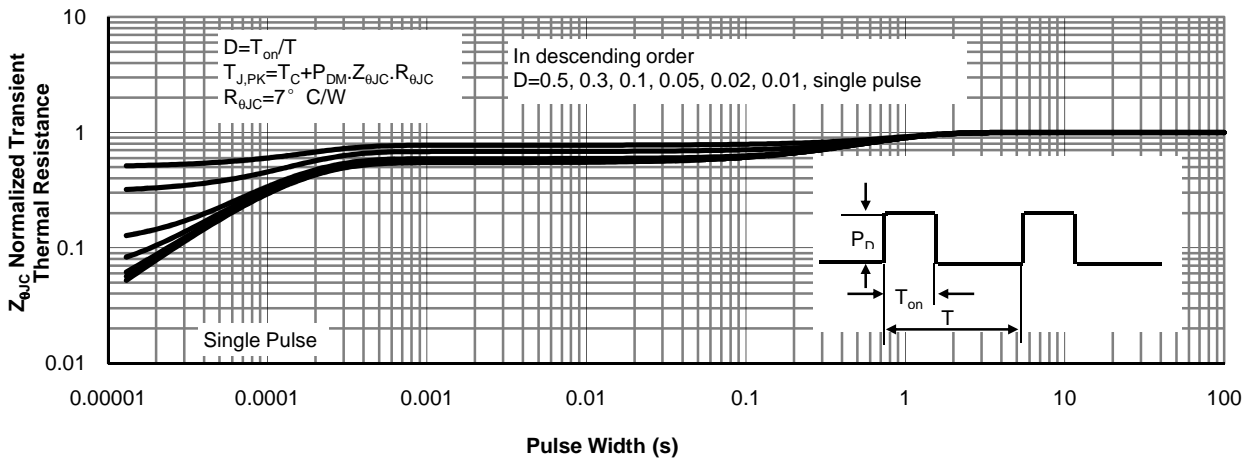

Figure 11: Normalized Maximum Transient Thermal Impedance (Note F)

TYPICAL ELECTRICAL AND THERMAL CHARACTERISTICS

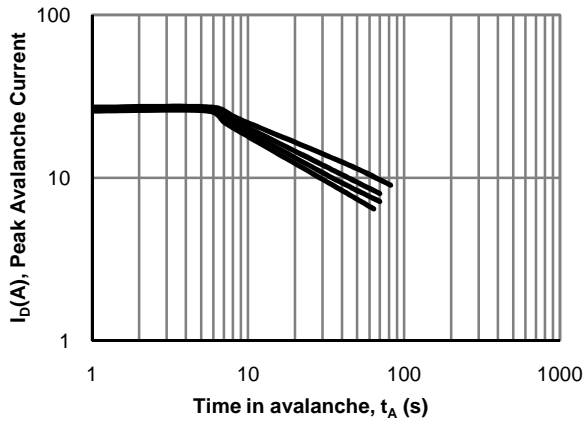

Figure 12: Single Pulse Avalanche capability

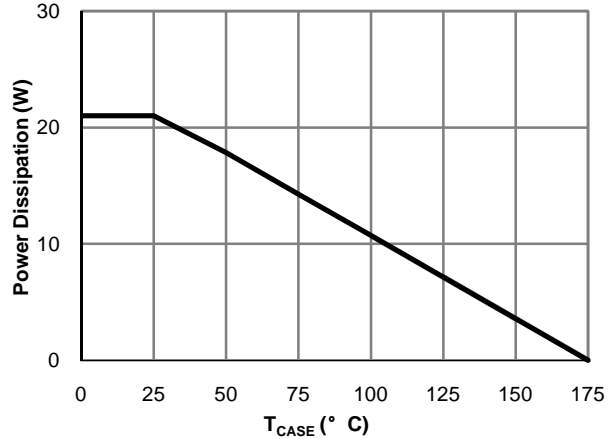

Figure 13: Power De-rating (Note B)

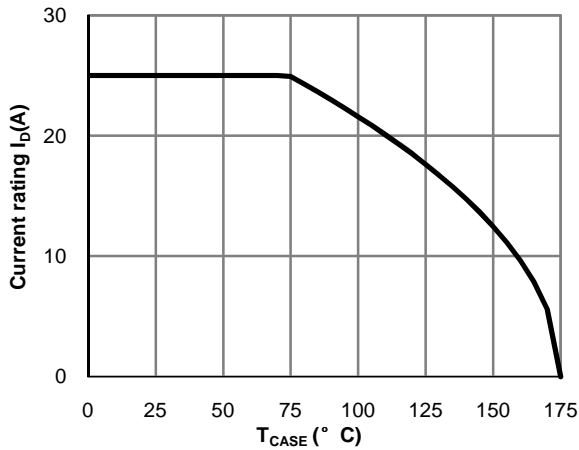

Figure 14: Current De-rating (Note B)

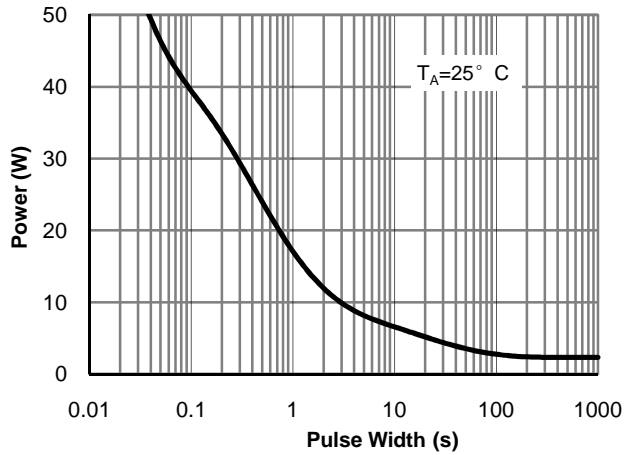

Figure 15: Single Pulse Power Rating Junction-to-Ambient (Note H)

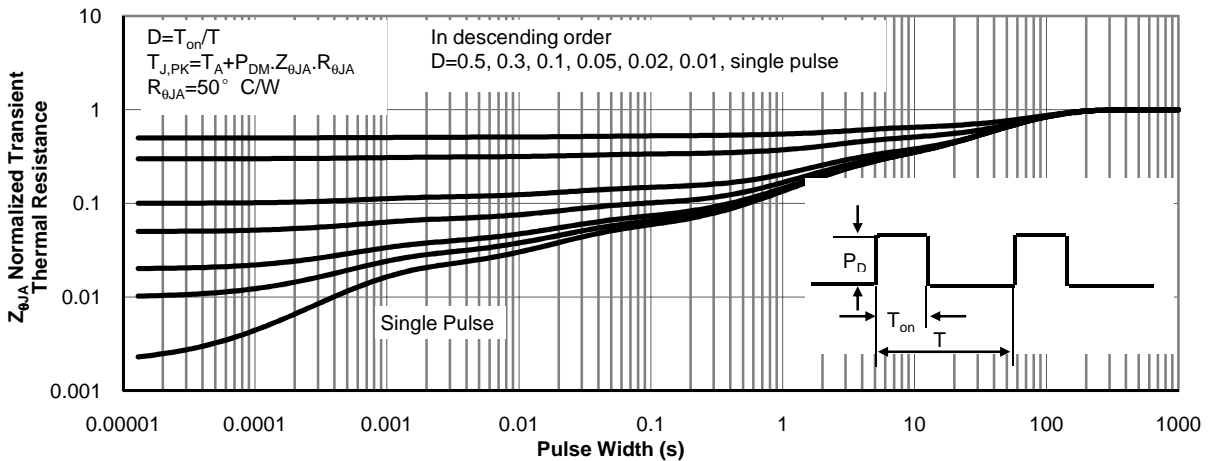
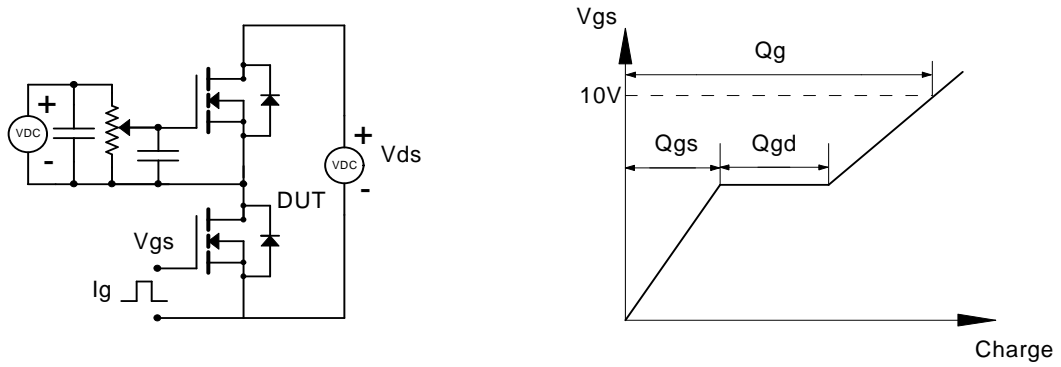
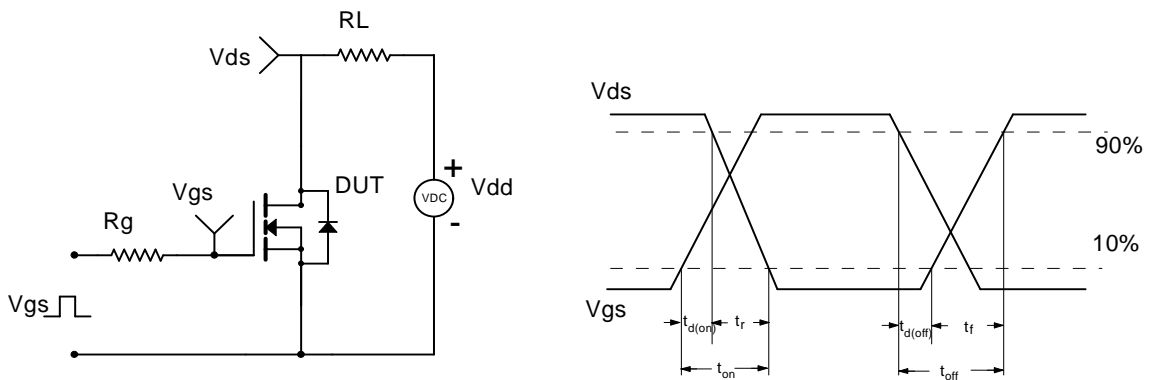

Figure 16: Normalized Maximum Transient Thermal Impedance (Note H)

Gate Charge Test Circuit & Waveform



Resistive Switching Test Circuit & Waveforms



Unclamped Inductive Switching (UIS) Test Circuit & Waveforms

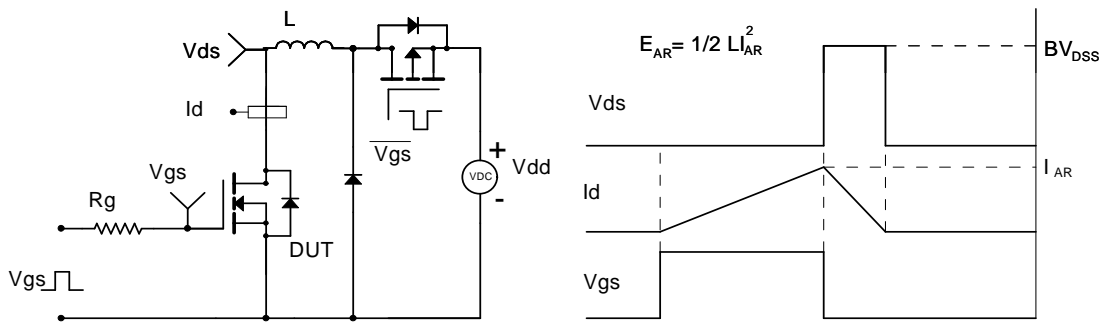

Diode Recovery Test Circuit & Waveforms

