

# Combination Voltage Selector, Fuse Holder and IEC Connector

SCREW MOUNT  
42R34-1



SNAP-IN  
42R34-3



42R34 ACCEPTS EUROPEAN  
5x20mm FUSE ONLY

FACE DIMENSIONS SCREW MOUNT

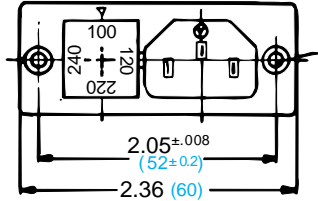

PANEL CUT-OUT

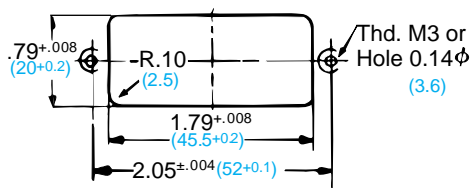

FACE DIMENSIONS SNAP-IN

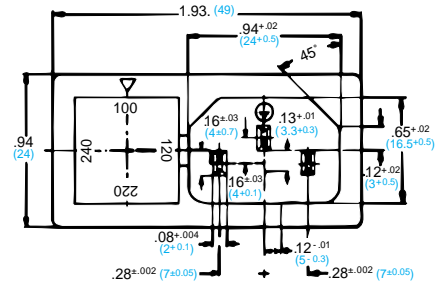

⑩ Fuse holder snaps out.

☞ Pull out fuse holder & insert fuse into voltage selector/ fuse holder.

① Reinsert fuse holder with desired voltage at top.



Specifications subject to change without notice. (Metric dimensions are shown in parentheses.) See pages 293-300 for mating power cords.

NOTE: We have modified our fuse cover markings to conform to the new European voltage standards to go in effect in 1995. Changing your specifications now will assure your compliance with these new standards.



# EXAMPLE & ORDERING CODE

42R34- 3 1 1 1 - 200

**MECHANICAL MOUNTING CONFIGURATION**

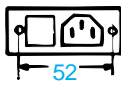
SCREW MOUNT  =1

SNAP-IN  =3

**COLOR**  
Other colors available on request.





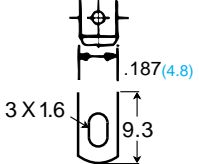

BLACK =1  
GRAY =2







**TERMINAL DIMENSIONS**









QUICK CONNECT =1  
SOLDER =2

**ELECTRICAL CIRCUIT CONFIGURATION**

      10A 250V 65°C 2+Ground  =1

     10A 250V 120°C 2+Ground  =2

     10A 250V 65°C 2 Pole  =4

**PANEL THICKNESS (SNAP-INS ONLY)**

.06 (1.5mm) =150  
.08 (2.0mm) =200  
.10 (2.5mm) =250

Additional panel thickness available on request.

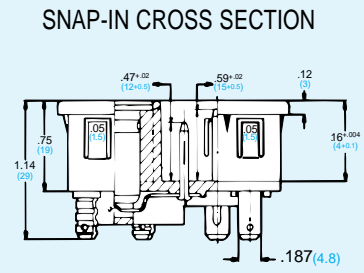

Integral combination IEC power cord connector/fuse holder/voltage selector. Meets all international safety requirements; may be used without modification at time of installation. Designed to switch voltages 115, 125, 230, 250 by removing fuse cartridge & rotating to desired voltage, then snapping the cartridge back into connector housing. Fuse holder is touch proof in accordance with international product safety requirements. Series 42R34 accepts one international 5 x 20mm fuse. Series 42R38, page 232-233 accepts one standard 3 AG American type fuse. Rated 10 Amp., 250 VAC, 65°C to 120°C operating temperature. Screw or snap-in mount configurations.

## SPECIFICATIONS

### MATERIAL AND FINISH:

Housing:  
Material: Polycarbonate  
Rating: UL 94V-0

### Contacts:

Quick Connect:  
Material: Brass  
Plating: Nickel  
Solder:  
Material: Copper  
Plating: Tin

### ELECTRICAL SPECIFICATIONS:

Insulation Resistance: 100 Megaohm min. @ 500 VDC  
Dielectric Strength: 2000 VAC for 1 minute

Specifications subject to change without notice. (Metric dimensions are shown in parentheses.)  
See pages 293-300 for mating power cords.

42R70-1

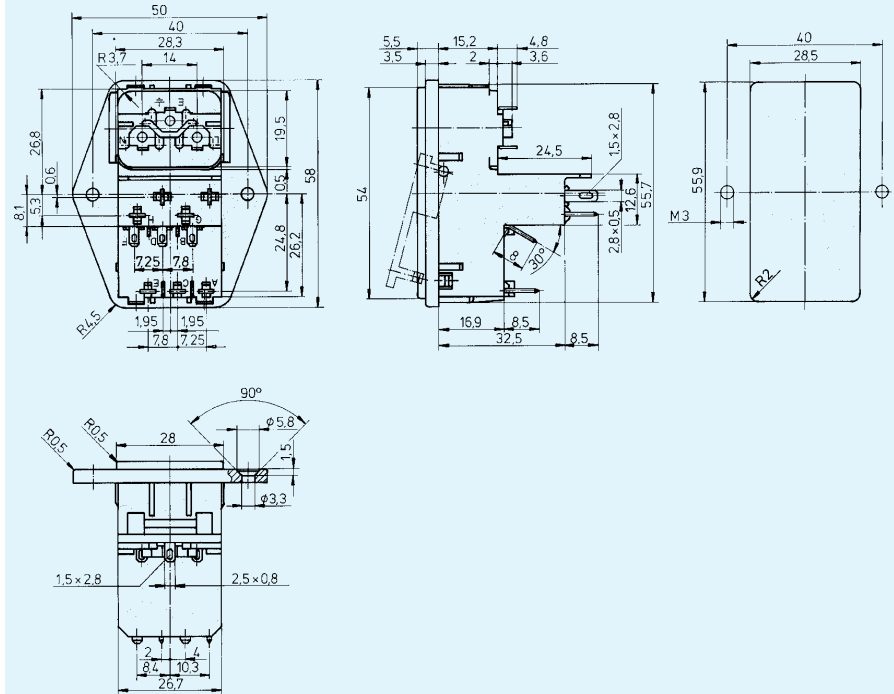

42R70-2

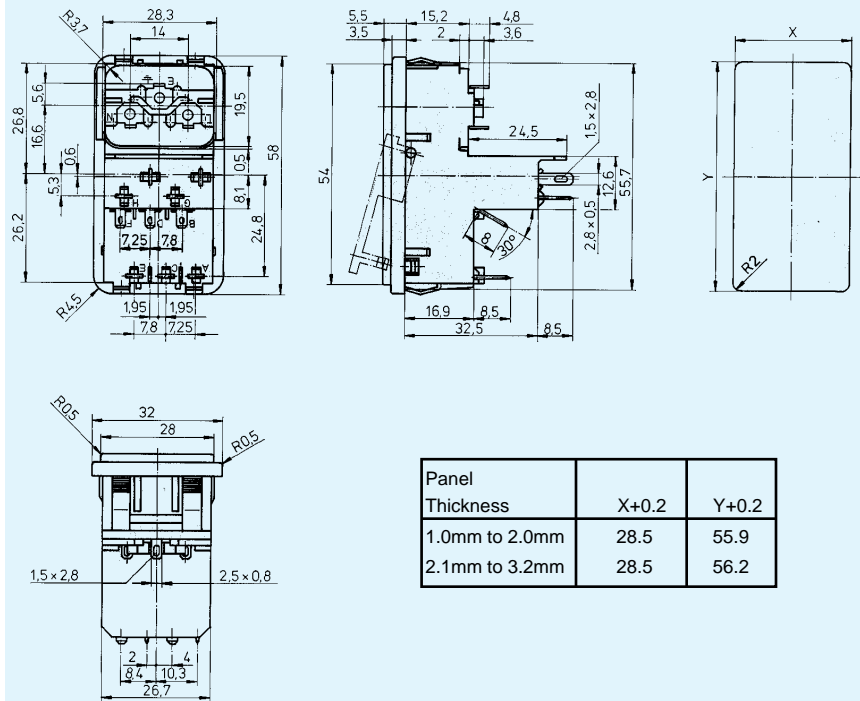

Specifications subject to change without notice. Dimensions in mm. See pages 293-300 for mating power cords.



# EXAMPLE & ORDERING CODE

42R70 - 2 1 1 2 - 2





**MECHANICAL MOUNTING CONFIGURATION:**

 FLANGE WITHOUT SWITCH = 1

 UNIVERSAL SNAP-IN (Range 1.0mm to 3.2mm) = 2

**COLOR:** BLACK = 1

**ELECTRICAL CIRCUIT CONFIGURATION**

   6A 250V 65°C 2+GROUND  = 1

**FUSE SELECTION:**

1 FUSE AMERICAN 3AG = 1

2 FUSE AMERICAN 3AG = 2

1 FUSE EUROPEAN 5mm x 20mm = 3

2 FUSE EUROPEAN 5mm x 20mm = 4

**VOLTAGE SELECTOR:**

110, 120, 220, 240VAC = 1

115, 115, 230, 230VAC = 2

110, 220, 240VAC = 3

115, 230VAC = 4

115, 230VAC = 5

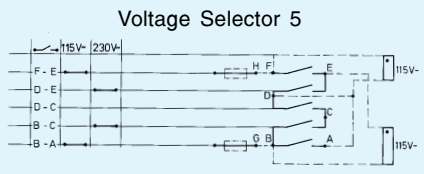
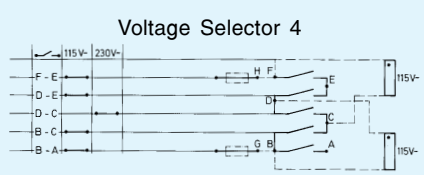
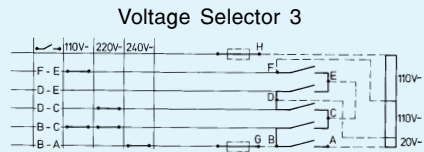
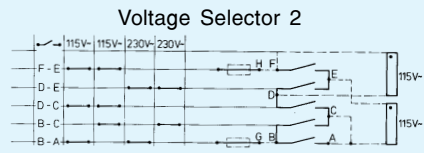
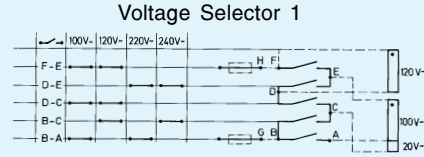

## SPECIFICATIONS

**MATERIAL AND FINISH:**

Housing:  
 Material: P.B.T.  
 Rating: UL 94V-0

Contacts:  
 Material: Copper Alloy  
 Plating: Tin

Strips:  
 Material: Brass  
 Plating: Tin

**ELECTRICAL SPECIFICATIONS:**

Insulation Resistance: 100 Megaohm min. @ 500 VDC

Dielectric Strength: 2000 VAC for 1 minute

Specifications subject to change without notice.  
 See pages 293-300 for mating power cords.

**IEC CONNECTORS**

**18**

