

**Features**

- High slew rates
- High input impedance—500 MΩ
- Low input bias currents—1 nA
- Low input offset current—1 nA
- High gain—> 100 dB
- Output short circuit protected
- Output clamp
- Low input offset voltage—500 μV

**Applications**

- Video amplifiers
- Precision comparators
- Pulse amplifiers
- DAC buffers
- High-speed sample and holds

**General Description**

Elantec's EHA2600 Series of high performance op amps is designed to offer designers high-speed amplifiers without sacrificing DC characteristics. These products are fabricated using Elantec's Complementary Bipolar processes.

Two different versions are offered. The EHA260X series which is internally compensated and unity gain stable, and the EHA262X series that is optimized for slew rate and bandwidth.

These devices are used in a wide variety of applications including video signal conditioning, instrumentation, and data acquisition systems. For any application that requires high-speed AC and good DC performance to accurately process signals, the EHA2600 series provides excellent performance with over a 100 dB of gain, 1 nA of bias current and gain bandwidths to 100 MHz.

Elantec facilities comply with MIL-I-45208A and other applicable quality specifications. For information on Elantec's military processing, request our brochure: *Elantec's Military Processing—Monolithic Products.*

**Connection Diagrams**

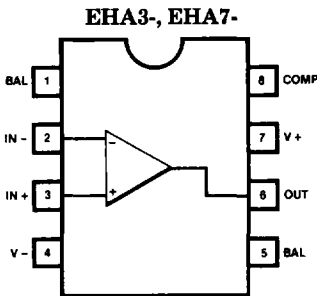

2600-1

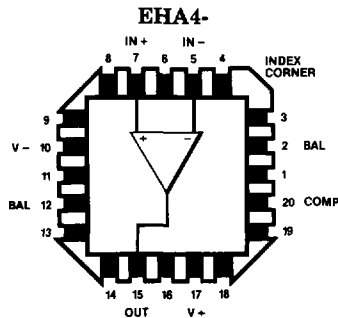

2600-2

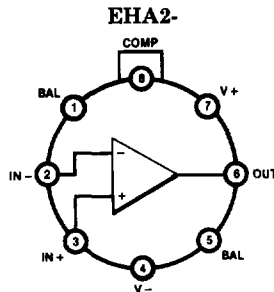

2600-3

Note: Non-designated pins are no connects and are not electrically connected internally.

Top Views

# EHA2600 Series

## Wideband, High Impedance Operational Amplifier

EHA2600 SERIES

1

### Selection Guide

Part Number	Temp	V <sub>OS</sub> (Max) mV	I <sub>BIAS</sub> (Max) nA	I <sub>OS</sub> (Max) nA	G <sub>BW</sub> (Typ) MHz	PBW (Min) kHz	S <sub>R</sub> (Min) V/μs	t <sub>SET</sub> (Typ) μs	PSRR, CMRR (Min) dB	R <sub>IN</sub> (Min) MΩ	Minimum Stable Gain
EHA2600	M	4	10	10	12	50	4	1.5	80	100	1
EHA2602	M	5	25	25	12	50	4	1.5	74	40	1
EHA2605	C	5	25	25	12	50	4	1.5	74	40	1
EHA2620	M	4	15	15	100	400	25	—	80	65	5
EHA2622	M	5	25	25	100	320	20	—	74	40	5
EHA2625	C	5	25	25	100	320	20	—	74	40	5

### Ordering Information

Dice (Note 1) (EHA0-)	14-Pin DIP Ceramic (EHA1-)	TO-99 Metal Can (EHA2-)	8-Pin DIP Plastic (EHA3-)	LCC 20-Pin (EHA4-)	8-Pin DIP CerDIP (EHA7-)
EHA0-2600-6		EHA2-2600/883B EHA2-2600-2 EHA2-2600-1 (Note 3)			EHA7-2600/883B EHA7-2600-2
EHA0-2602-6		EHA2-2602/883B EHA2-2602-2			EHA7-2602/883B EHA7-2602-2
EHA0-2605-6		EHA2-2605-5	EHA3-2605-5		EHA7-2605-5
EHA0-2620-6	(Note 2) (Note 2)	EHA2-2620/883B EHA2-2620-2 EHA2-2620-1 (Note 3)		EHA4-2620/883B	EHA7-2620/883B EHA7-2620-2
EHA0-2622-6	(Note 2) (Note 2)	EHA2-2622/883B EHA2-2622-2			EHA7-2622/883B EHA7-2622-2
EHA0-2625-6	(Note 2)	EHA2-2625-5	EHA3-2625-5		EHA7-2625-5

Note 1: Dice are available in wafer packs. Consult factory for more information.

Note 2: Consult factory for special packaging or temperature range requirements.

Note 3: Contact factory for minimum quantity and availability.

#### PREFIX

EHA2-	TO-99 Metal Can	MDP0004
EHA3-	8-Pin Plastic DIP	MDP0031
EHA4-	Leadless Chip Carrier (LCC)	MDP0007
EHA7-	8-Pin CerDIP	MDP0010
EHA0-	Dice	

#### SUFFIX

-1	0°C to +200°C
-2	-55°C to +125°C
-3	
-4	-25°C to +85°C
-5	0°C to +75°C
-6	100% 25°C Probe (Dice Only)
-7	
/883B	See Elantec's "Military Processing— Monolithic Products".
-9	

# EHA2600/2602/2605

## Wideband, High Impedance Operational Amplifier

### Absolute Maximum Ratings

V <sub>S</sub>	Supply Voltage	±22.5V	T <sub>A</sub>	Operating Temperature Range	
V <sub>IN</sub>	Differential Input Voltage	±12V		EHA2600/02	-55°C to +125°C
P <sub>D</sub>	Maximum Power Dissipation	See Curves		EHA2605	0°C to +75°C
I <sub>OP</sub>	Peak Output Current	Short Circuit Protected	T <sub>ST</sub>	Storage Temperature	-65°C to +150°C
				Lead Temperature	
				(Soldering, 5 seconds)	300°C

#### Important Note:

All parameters having Min/Max specifications are guaranteed. The Test Level column indicates the specific device testing actually performed during production and Quality inspection. Elantec performs most electrical tests using modern high-speed automatic test equipment, specifically the LTX77 Series system. Unless otherwise noted, all tests are pulsed tests, therefore  $T_J = T_C = T_A$ .

Test Level	Test Procedure
I	100% production tested and QA sample tested per QA test plan QCX0002.
II	100% production tested at T <sub>A</sub> = 25°C and QA sample tested at T <sub>A</sub> = 25°C, T <sub>MAX</sub> and T <sub>MIN</sub> per QA test plan QCX0002.
III	QA sample tested per QA test plan QCX0002.
IV	Parameter is guaranteed (but not tested) by Design and Characterization Data.
V	Parameter is typical value at T <sub>A</sub> = 25°C for information purposes only.

### DC Electrical Characteristics

V<sub>S</sub> = ±15V, R<sub>S</sub> = 50Ω, R<sub>L</sub> = 100 kΩ, V<sub>CM</sub> = 0V, V<sub>OUT</sub> = 0V, C<sub>L</sub> ≤ 10 pF, T<sub>MIN</sub> ≤ T<sub>A</sub> ≤ T<sub>MAX</sub>, unless otherwise specified

Parameter	Description	Test Conditions	EHA2600				EHA2602				EHA2605				Units	
			Min	Typ	Max	Test Level	Min	Typ	Max	Test Level	Min	Typ	Max	Test Level		
V <sub>OS</sub>	Offset Voltage	T <sub>A</sub> = 25°C		0.5	4	I		3	5	I		3	5	I	mV	
				2	6	I		7	I		7	III	mV			
ΔV <sub>OS</sub> /ΔT	Offset Voltage Drift			5		V		5		V		5		V	μV/°C	
I <sub>B</sub>	Bias Current (Note 1)	T <sub>A</sub> = 25°C		1	10	I		15	25	I		15	25	I	nA	
				10	50	I		60	I		40	III	nA			
I <sub>OS</sub>	Offset Current	T <sub>A</sub> = 25°C		1	10	I		5	25	I		5	25	I	nA	
				5	50	I		60	I		40	III	nA			
R <sub>IN</sub>	Input Resistance	T <sub>A</sub> = 25°C	100	500		IV	40	300		IV	40	300		IV	MΩ	
V <sub>CMR</sub>	Common-Mode Range			±11		IV		±11		IV		±11		IV	V	
CMRR	Common-Mode Rejection Ratio (Note 2)	ΔV <sub>CM</sub> = ±10V		80	100		I	74	100		I	74	100		II	dB
PSRR	Power Supply Rejection Ratio (Note 3)	ΔV <sub>S</sub> = ±5V		80	90		I	74	90		I	74	90		II	dB
A <sub>VOL</sub>	Large Signal Voltage Gain (Note 4)	R <sub>L</sub> = 2 kΩ, V <sub>O</sub> = ±10V, T <sub>A</sub> = 25°C		100	150		I	80	150		I	80	150		I	kV/V
		R <sub>L</sub> = 2 kΩ, V <sub>O</sub> = ±10V		70			I	60			I	70			III	kV/V
V <sub>OUT</sub>	Output Voltage Swing	R <sub>L</sub> = 2 kΩ		±10	±12		I	±10	±12		I	±10	±12		II	V

# EHA2600/2602/2605

## Wideband, High Impedance Operational Amplifier

EHA2600/2602/2605

1

### DC Electrical Characteristics

$V_S = \pm 15V$ ,  $R_S = 50\Omega$ ,  $R_L = 100\text{ k}\Omega$ ,  $V_{CM} = 0V$ ,  $V_{OUT} = 0V$ ,  $C_L \leq 10\text{ pF}$ ,  $T_{MIN} \leq T_A \leq T_{MAX}$ , unless otherwise specified — Contd.

Parameter	Description	Test Conditions	EHA2600				EHA2602				EHA2605				Units
			Min	Typ	Max	Test Level	Min	Typ	Max	Test Level	Min	Typ	Max	Test Level	
$I_{OUT}$	Output Current	$V_{OUT} = \pm 10V$ , $T_A = 25^\circ C$	$\pm 15$	$\pm 22$		I	$\pm 10$	$\pm 18$		I	$\pm 10$	$\pm 18$		I	mA
		$V_{OUT} = \pm 10V$	$\pm 7.5$			I	$\pm 7.5$			I	$\pm 7.5$			III	
$I_{CC}$	Supply Current (Note 5)	$T_A = 25^\circ C$		3	3.7	I		3	4	I		3	4	I	mA

### AC Electrical Characteristics

$V_S = \pm 15V$ ,  $R_L = 2\text{ k}\Omega$ ,  $C_L = 100\text{ pF}$ ,  $V_{OUT} = \pm 200\text{ mV}$ ,  $T_{MIN} \leq T_A \leq T_{MAX}$ , unless otherwise specified (See AC test circuit)

Parameter	Description	Test Conditions	EHA2600				EHA2602				EHA2605				Units
			Min	Typ	Max	Test Level	Min	Typ	Max	Test Level	Min	Typ	Max	Test Level	
$t_r, t_f$	Rise and Fall Times	$T_A = 25^\circ C$		30	60	I		30	60	I		30	60	I	ns
					70	I			70	I			70	III	ns
SR	Slew Rate	$V_{OUT} = \pm 5V$ , $T_A = 25^\circ C$	$\pm 4$	$\pm 7$		I	$\pm 4$	$\pm 7$		I	$\pm 4$	$\pm 7$		I	V/ $\mu s$
BW	Unity Gain Bandwidth (Note 6)	$V_{OUT} < 90\text{ mV}$ , $T_A = 25^\circ C$		12		V		12		V		12		V	MHz
FPBW	Full Power Bandwidth (Note 6)	$V_{OUT} = \pm 10V$ , $T_A = 25^\circ C$	50	75		IV	50	75		IV	50	75		IV	kHz
O.S.	Overshoot	$T_A = 25^\circ C$		25	40	I		25	40	I		25	40	I	%
					50	I			50	I			50	III	%
$t_s$	Settling Time to 0.1%	$V_{OUT} = \pm 5V$ , $T_A = 25^\circ C$		1.5		V		1.5		V		1.5		V	$\mu s$

Note 1: Both input currents,  $I_{B+}$ , and  $I_{B-}$ , are tested individually.

Note 2: For  $CMRR+$ ,  $V_{CM} = 0V$  to  $+10V$  and for  $CMRR-$ ,  $V_{CM} = 0V$  to  $-10V$ .

Note 3:  $PSRR+$ ,  $V_{S+} = +10V$  to  $+20V$  with  $V_{S-} = -15V$ . For  $PSRR-$ ,  $V_{S-} = -10V$  to  $-20V$  with  $V_{S+} = +15V$ .

Note 4: For  $AVOL+$ ,  $V_{OUT} = 0V$  to  $+10V$  and for  $AVOL-$ ,  $V_{OUT} = 0V$  to  $-10V$ .

Note 5: Both positive and negative supply currents,  $I_{CC+}$ , and  $I_{CC-}$ , are tested.

Note 6: The Full Power Bandwidth is guaranteed by testing slew rate,  $FPBW = SR/(2\pi V_P)$ .

EHA260X A.C. Test Circuit

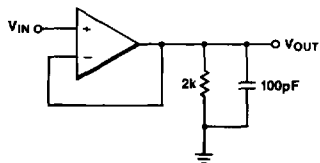

2600-4

# EHA 2600/2602/2605

## Wideband, High Impedance Operational Amplifier

### Typical Performance Curves

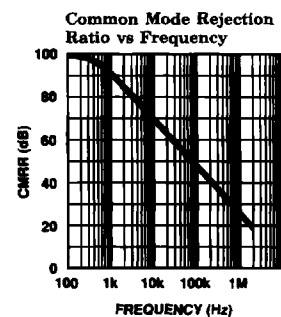
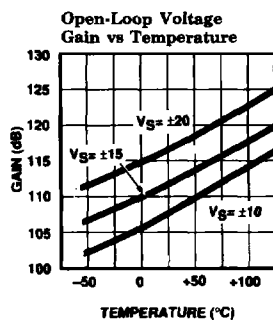
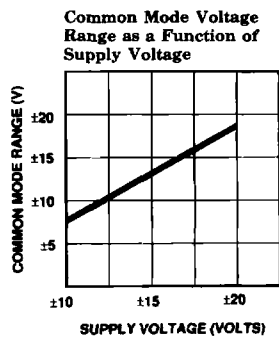
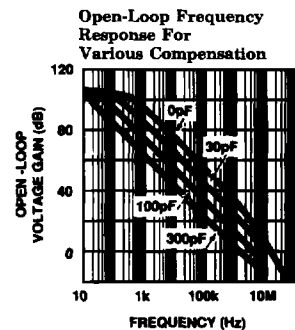
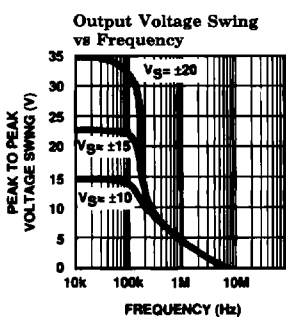
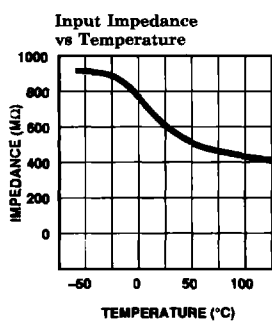
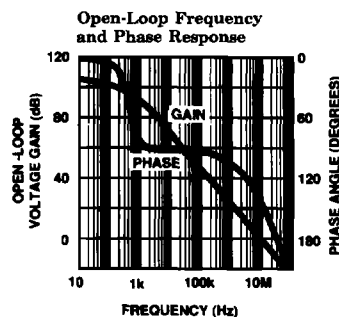
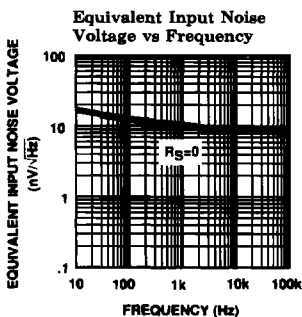
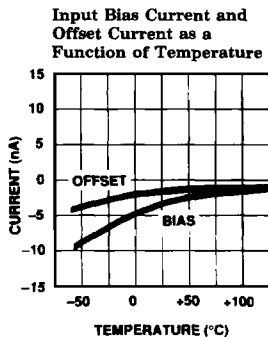

# EHA2600/2602/2605

## Wideband, High Impedance Operational Amplifier

EHA2600/2602/2605

1

### Typical Performance Curves — Contd.

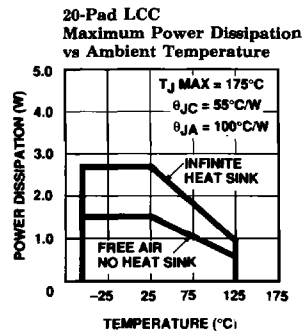
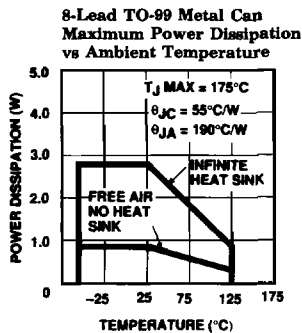
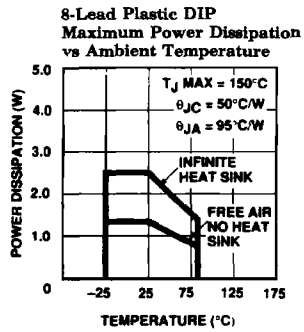
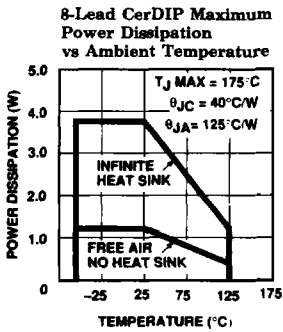

2600-6

# EHA2620/2622/2625

## Wideband, High Impedance Operational Amplifier

### Absolute Maximum Ratings

V <sub>S</sub>	Supply Voltage	± 22.5V	T <sub>A</sub>	Operating Temperature Range	
V <sub>IN</sub>	Differential Input Voltage	± 12.0V		EHA2620/22	-55°C to +125°C
P <sub>D</sub>	Maximum Power Dissipation	See Curves		EHA2625	0°C to +75°C
I <sub>OP</sub>	Peak Output Current	Short Circuit Protected	T <sub>ST</sub>	Storage Temperature	-65°C to +150°C
				Lead Temperature	
				(Soldering, 5 seconds)	300°C

#### Important Note:

All parameters having Min/Max specifications are guaranteed. The Test Level column indicates the specific device testing actually performed during production and Quality inspection. Elantec performs most electrical tests using modern high-speed automatic test equipment, specifically the LTX77 Series system. Unless otherwise noted, all tests are pulsed tests, therefore  $T_J = T_C = T_A$ .

#### Test Level

#### Test Procedure

I	100% production tested and QA sample tested per QA test plan QCX0002.
II	100% production tested at T <sub>A</sub> = 25°C and QA sample tested at T <sub>A</sub> = 25°C, T <sub>MAX</sub> and T <sub>MIN</sub> per QA test plan QCX0002.
III	QA sample tested per QA test plan QCX0002.
IV	Parameter is guaranteed (but not tested) by Design and Characterization Data.
V	Parameter is typical value at T <sub>A</sub> = 25°C for information purposes only.

### DC Electrical Characteristics

V<sub>S</sub> = ± 15V, R<sub>S</sub> = 50Ω, R<sub>L</sub> = 100 kΩ, V<sub>CM</sub> = 0V, V<sub>OUT</sub> = 0V, T<sub>MIN</sub> ≤ T<sub>A</sub> ≤ T<sub>MAX</sub>, unless otherwise specified

Parameter	Description	Test Conditions	EHA2620				EHA2622				EHA2625				Units
			Min	Typ	Max	Test Level	Min	Typ	Max	Test Level	Min	Typ	Max	Test Level	
V <sub>OS</sub>	Offset Voltage	T <sub>A</sub> = 25°C		0.5	4	I		3	5	I		3	5	I	mV
				2	6	I		7	I		7	III	mV		
ΔV <sub>OS</sub> /ΔT	Offset Voltage Drift			5		V		5		V		5		V	μV/°C
I <sub>B</sub>	Bias Current (Note 1)	T <sub>A</sub> = 25°C		1	15	I		15	25	I		15	25	I	nA
				10	50	I		60	I		40	III	nA		
I <sub>OS</sub>	Offset Current	T <sub>A</sub> = 25°C		1	15	I		5	25	I		5	25	I	nA
				5	50	I		60	I		40	III	nA		
R <sub>IN</sub>	Input Resistance	T <sub>A</sub> = 25°C	65	500		IV	40	300		IV	40	300		IV	MΩ
V <sub>CMR</sub>	Common-Mode Range		± 11.0			IV	± 11.0			IV	± 11.0			IV	V
CMRR	Common-Mode Rejection Ratio (Note 2)	ΔV <sub>CM</sub> = ± 10V	80	100		I	74	100		I	74	100		II	dB
PSRR	Power Supply Rejection Ratio (Note 3)	ΔV <sub>S</sub> = ± 5V	80	90		I	74	90		I	74	90		II	dB

# EHA2620/2622/2625

## Wideband, High Impedance Operational Amplifier

EHA2620/2622/2625

### DC Electrical Characteristics

$V_S = \pm 15V$ ,  $R_S = 50\Omega$ ,  $R_L = 100\text{ k}\Omega$ ,  $V_{CM} = 0V$ ,  $V_{OUT} = 0V$ ,  $T_{MIN} \leq T_A \leq T_{MAX}$ , unless otherwise specified — Contd.

Parameter	Description	Test Conditions	EHA2620				EHA2622				EHA2625				Units
			Min	Typ	Max	Test Level	Min	Typ	Max	Test Level	Min	Typ	Max	Test Level	
A <sub>VOL</sub>	Large Signal Voltage Gain (Note 4)	R <sub>L</sub> = 2 k $\Omega$ , V <sub>O</sub> = $\pm 10V$ , T <sub>A</sub> = 25°C	100	150		I	80	150		I	80	150		I	kV/V
		R <sub>L</sub> = 2 k $\Omega$ , V <sub>O</sub> = $\pm 10V$	70			I	60			I	70			III	kV/V
V <sub>O</sub>	Output Voltage Swing	R <sub>L</sub> = 2 k $\Omega$	$\pm 10$	$\pm 12$		I	$\pm 10$	$\pm 12$		I	$\pm 10$	$\pm 12$		II	V
I <sub>OUT</sub>	Output Current	V <sub>OUT</sub> = $\pm 10V$ , T <sub>A</sub> = 25°C	$\pm 15$	$\pm 22$		I	$\pm 10$	$\pm 18$		I	$\pm 10$	$\pm 18$		I	mA
		V <sub>OUT</sub> = $\pm 10V$	$\pm 7.5$			I	$\pm 7.5$			I	$\pm 7.5$			III	mA
I <sub>CC</sub>	Supply Current (Note 5)	T <sub>A</sub> = 25°C		3	3.7		I			3	4		I		mA

### AC Electrical Characteristics

$V_S = \pm 15V$ ,  $R_S = 50\Omega$ ,  $R_L = 2\text{ k}\Omega$ ,  $C_L = 50\text{ pF}$ ,  $V_{OUT} = \pm 200\text{ mV}$ ,  $T_{MIN} \leq T_A \leq T_{MAX}$ , unless otherwise specified

(See AC test circuit)

Parameter	Description	Test Conditions	EHA2620				EHA2622				EHA2625				Units
			Min	Typ	Max	Test Level	Min	Typ	Max	Test Level	Min	Typ	Max	Test Level	
t <sub>r</sub> , t <sub>f</sub>	Rise and Fall Times	A <sub>V</sub> = 5V, T <sub>A</sub> = 25°C		17	45	I		17	45	I		30	45	I	ns
		A <sub>V</sub> = 5V			60	I			70	I			70	III	ns
SR	Slew Rate	V <sub>OUT</sub> = $\pm 5V$ , A <sub>V</sub> = 5V, T <sub>A</sub> = 25°C	$\pm 25$	$\pm 35$		I	$\pm 20$	$\pm 35$		I	$\pm 20$	$\pm 35$		I	V/ $\mu$ s
GBW	Gain Bandwidth Product	V <sub>O</sub> $\leq 90\text{ mV}$ , A <sub>V</sub> = 100V, T <sub>A</sub> = 25°C		100		V		100		V		100		V	MHz
FPBW	Full Power Bandwidth (Note 6)	V <sub>OUT</sub> = $\pm 10V$ , T <sub>A</sub> = 25°C	400	600		IV	320	600		IV	320	600		IV	kHz
O.S.	Overshoot	T <sub>A</sub> = 25°C			60	I			60	I			60	I	%
					70	I			70	I			70	III	%

Note 1: Both input currents, I<sub>B+</sub>, and I<sub>B-</sub>, are tested individually.

Note 2: For CMRR+, V<sub>CM</sub> = 0V to +10V and for CMRR-, V<sub>CM</sub> = 0V to -10V.

Note 3: PSRR+, V<sub>S+</sub> = +10V to +20V with V<sub>S-</sub> = -15V. For PSRR-, V<sub>S-</sub> = -10V to -20V with V<sub>S+</sub> = +15V.

Note 4: For A<sub>VOL+</sub>, V<sub>OUT</sub> = 0V to +10V and for A<sub>VOL-</sub>, V<sub>OUT</sub> = 0V to -10V.

Note 5: Both positive and negative supply currents, I<sub>CC+</sub>, and I<sub>CC-</sub> are tested.

Note 6: The Full Power Bandwidth is guaranteed by testing slew rate, FPBW = SR/(2 $\pi$  V<sub>p</sub>).



# EHA 2620/2622/2625

## Wideband, High Impedance Operational Amplifier

### AC Electrical Characteristics — Contd.

EH262X AC Test Circuit

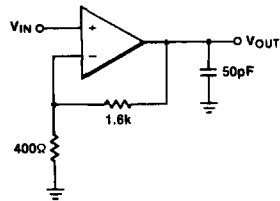

2600-7

### Burn-In Circuit

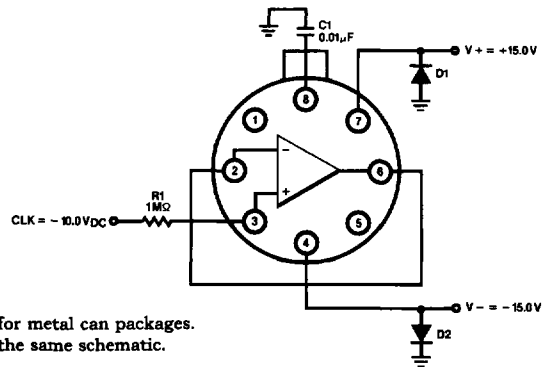

Pin numbers are for metal can packages.  
All packages use the same schematic.

Top View

2600-8

# EHA2620/2622/2625

## Wideband, High Impedance Operational Amplifier

EHA2620/2622/2625

### Typical Performance Curves

**Input Bias Current and Offset Current as a Function of Temperature**

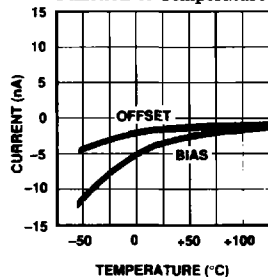

**Equivalent Input Noise Voltage vs Frequency**

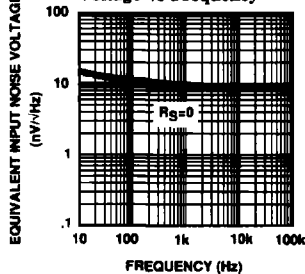

**Open-Loop Frequency and Phase Response**

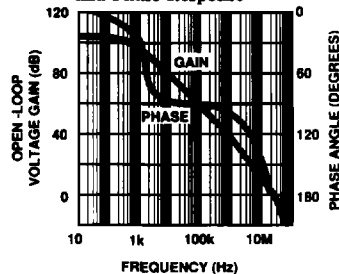

**Input Impedance vs Temperature**

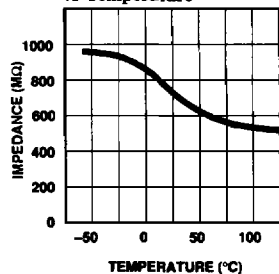

**Output Voltage Swing vs Frequency**

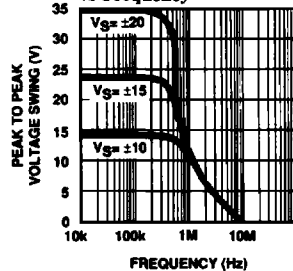

**Open-Loop Frequency Response For Various Compensation**

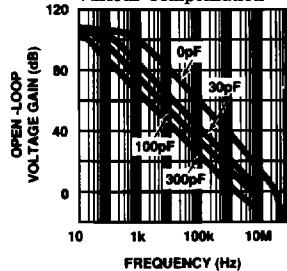

**Common Mode Voltage Range as a Function of Supply Voltage**

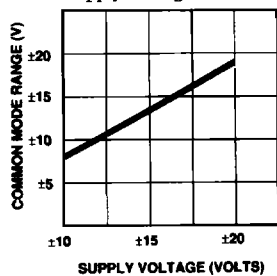

**Open-Loop Voltage Gain vs Temperature**

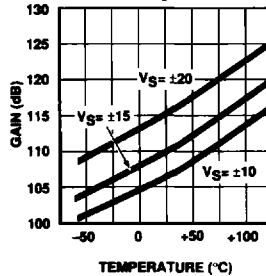

2800-9

1

# EHA 2620/2622/2625

## Wideband, High Impedance Operational Amplifier

### Typical Performance Curves — Contd.

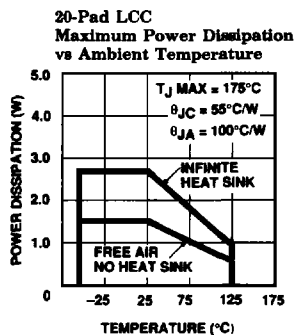
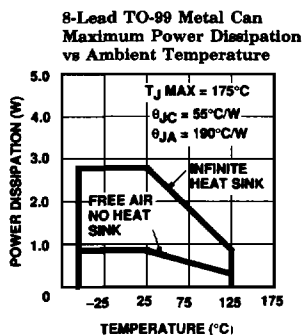
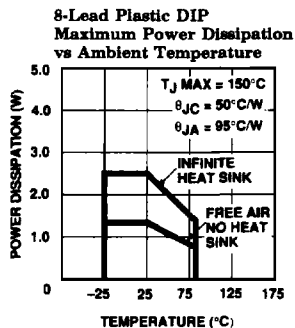
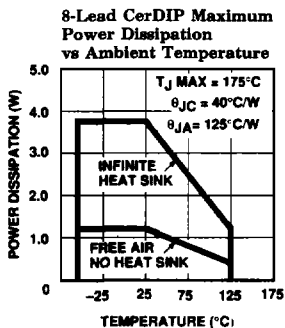

2800-10

# *EHA2600 Series*

## *Wideband, High Impedance Operational Amplifier*

### EHA2600 Macromodel

```

* Connections:  + input
*               |
*               |   - input
*               |   |   + Vsupply
*               |   |   |   - Vsupply
*               |   |   |   |   output
*               |   |   |   |   |   comp
*               |   |   |   |   |
.subckt M2600 3 2 7 4 6 8
* Input Stage
ie 37 4 26uA
r6 36 37 1K
r7 38 37 1K
rc1 7 30 3K
rc2 7 39 3K
q1 30 3 36 qn
q2 39 2 38 qna
ediff 33 0 39 30 1.00
rdiff 33 0 1Meg
* Compensation Section
ga 0 8 33 0 1m
rh 8 0 150Meg
ch 8 0 1.5pF
rc 8 40 5K
cc 40 0 1pF
* Poles
ep 41 0 40 0 1
rpa 41 42 200
cpa 42 0 8pF
rpb 42 43 1K
cpb 43 0 8pF
* Output Stage
ios1 7 50 1.0mA
ios2 51 4 1.0mA
q3 4 43 50 qp
q4 7 43 51 qn
q5 7 50 52 qn
q6 4 51 53 qp
ros1 52 6 25
ros2 6 53 25
* Power Supply Current
ips 7 4 0.5mA
* Models
.model qn npn(is = 800e-18 bf = 5e3 tf = 0.2nS)
.model qna npn(is = 864e-18 bf = 6e3 tf = 0.2nS)
.model qp pnp(is = 800e-18 bf = 5e3 tf = 0.2nS)
.ends
    
```

# EHA2600 Series

## Wideband, High Impedance Operational Amplifier

### EHA2600 Macromodel — Contd.

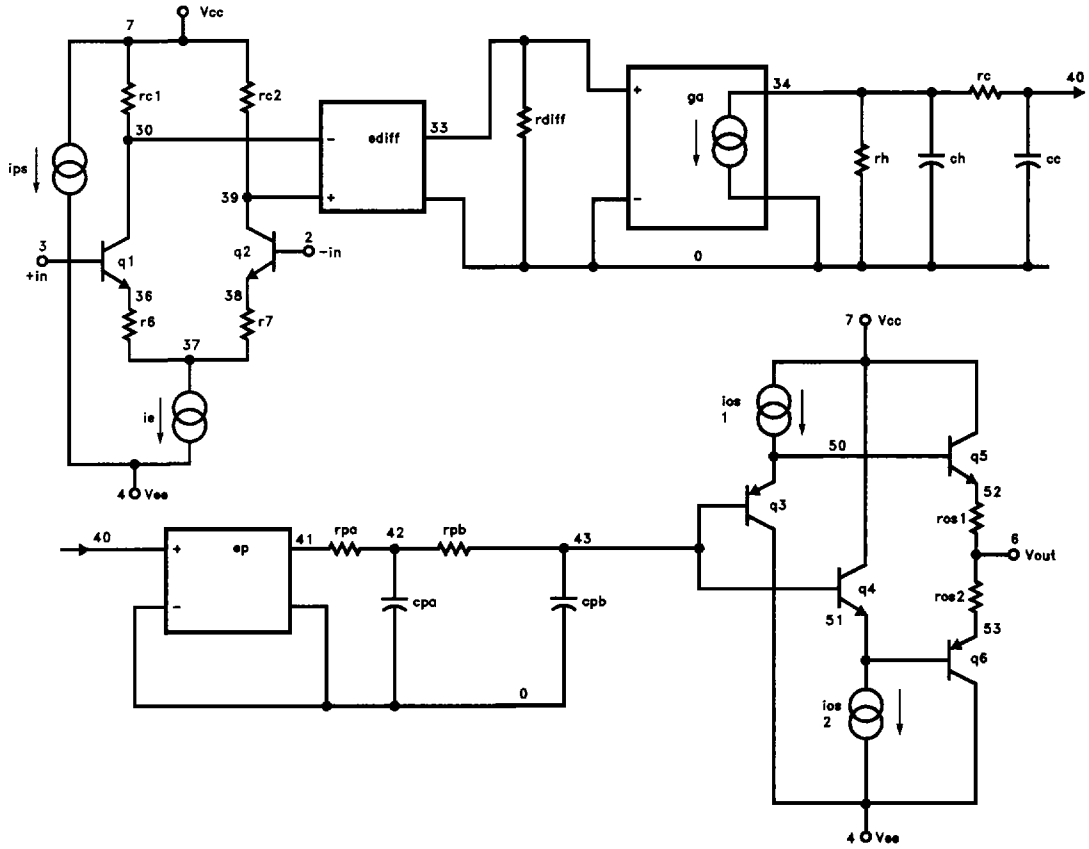

2800-11

# *EHA2600 Series*

## *Wideband, High Impedance Operational Amplifier*

### EHA2620 Macromodel

```

* Connections:      + input
*                  |
*                  |      -input
*                  |      |
*                  |      |      + Vsupply
*                  |      |      |
*                  |      |      |      -Vsupply
*                  |      |      |      |
*                  |      |      |      |      output
*                  |      |      |      |      |
*                  |      |      |      |      |      comp
*                  |      |      |      |      |
.subckt M2620      3      2      7      4      6      8
* Input Stage
ie 37 4 26uA
r6 36 37 1K
r7 38 37 1K
rc1 7 30 3K
rc2 7 39 3K
q1 30 3 36 qn
q2 39 2 38 qna
ediff 33 0 39 30 1.00
rdiff 33 0 1Meg
* Compensation Section
ga 0 8 33 0 1m
rh 8 0 150Meg
ch 8 0 1.5pF
rc 8 40 5K
cc 40 0 1pF
* Poles
ep 41 0 40 0 1
rpa 41 42 200
cpa 42 0 8pF
rpb 42 43 1K
cpb 43 0 8pF
* Output Stage
ios1 7 50 1.0mA
ios2 51 4 1.0mA
q3 4 43 50 qp
q4 7 43 51 qn
q5 7 50 52 qn
q6 4 51 53 qp
ros1 52 6 25
ros2 6 53 25
* Power Supply Current
ips 7 4 0.5mA
* Models
.model qn npn(is = 800.0e-18 bf = 5e3 tf = 0.2nS)
.model qna npn(is = 864e-18 bf = 6e3 tf = 0.2nS)
.model qp pnp(is = 800e-18 bf = 5e3 tf = 0.2nS)
.ends

```

# EHA2600 Series

## Wideband, High Impedance Operational Amplifier

**EHA2620 Macromodel — Contd.**

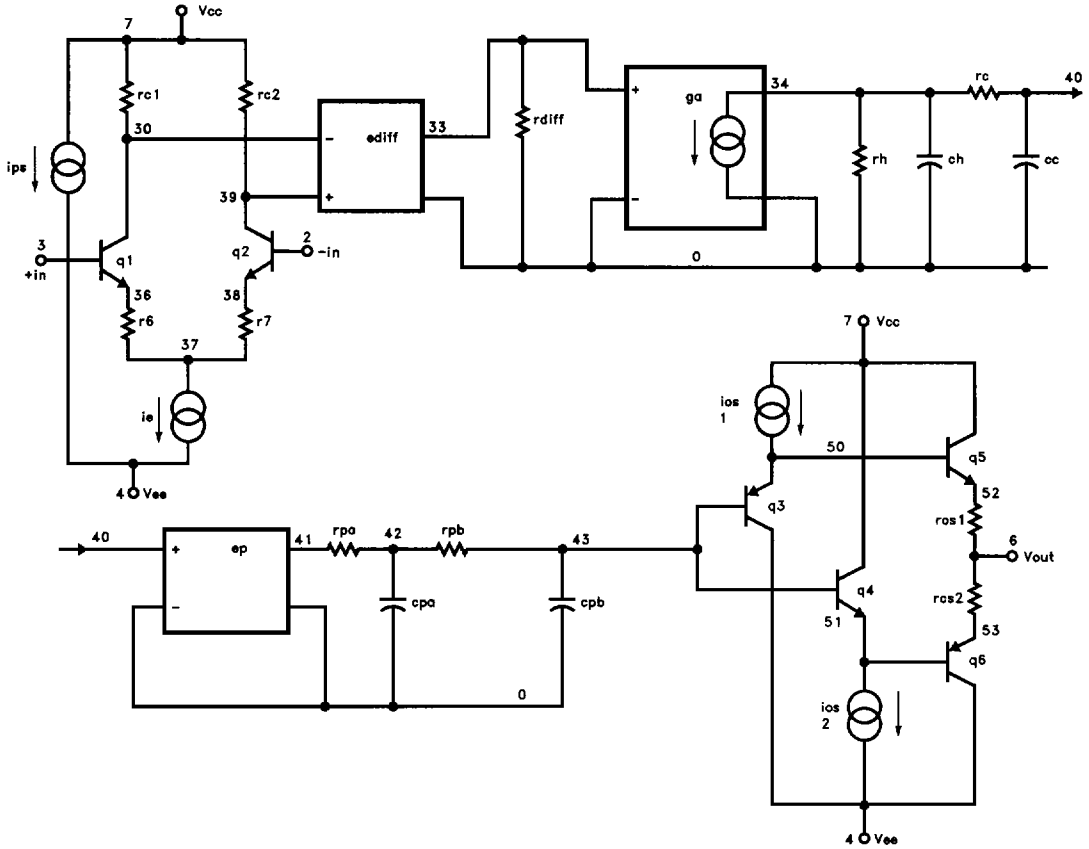

2800-12