

DATA SHEET

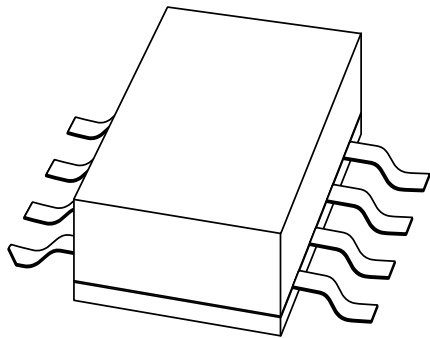

BLF202 HF/VHF power MOS transistor

Product specification
Supersedes data of 1999 Oct 20

2003 Sep 19

HF/VHF power MOS transistor

BLF202

FEATURES

- High power gain
- Easy power control
- Gold metallization
- Good thermal stability
- Withstands full load mismatch.

APPLICATIONS

- Communications transmitters in the HF/VHF range with a nominal supply voltage of 12.5 V.

DESCRIPTION

Silicon N-channel enhancement mode vertical D-MOS transistor in an 8-lead SOT409A SMD package with a ceramic cap.

PINNING - SOT409A

PIN	DESCRIPTION
1, 8	source
2, 3	gate
4, 5	source
6, 7	drain

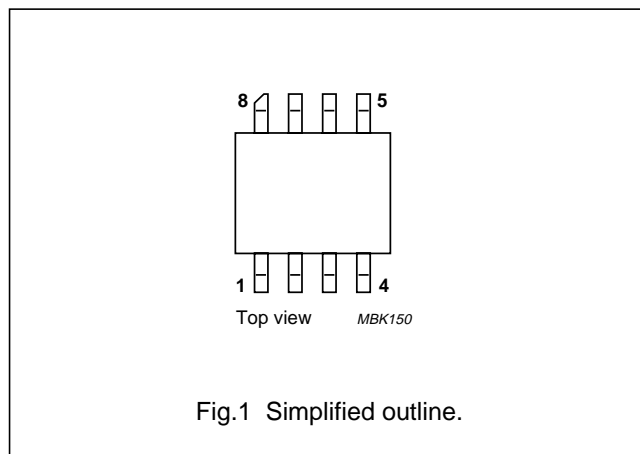

QUICK REFERENCE DATA

RF performance at $T_{mb} = 25\text{ }^\circ\text{C}$ in a common source test circuit.

MODE OF OPERATION	f (MHz)	V_{DS} (V)	P_L (W)	G_p (dB)	η_D (%)
CW, class-B	175	12.5	2	>10	>50

CAUTION

This product is supplied in anti-static packing to prevent damage caused by electrostatic discharge during transport and handling. For further information, refer to Philips specs.: SNW-EQ-608, SNW-FQ-302A, and SNW-FQ-302B.

HF/VHF power MOS transistor

BLF202

LIMITING VALUES

In accordance with the Absolute Maximum System (IEC 60134).

SYMBOL	PARAMETER	CONDITIONS	MIN.	MAX.	UNIT
V_{DS}	drain-source voltage		–	40	V
V_{GS}	gate-source voltage		–	± 20	V
I_D	drain current (DC)		–	1	A
P_{tot}	total power dissipation	$T_{mb} \leq 85\text{ }^\circ\text{C}$	–	5.7	W
T_{stg}	storage temperature		–65	150	$^\circ\text{C}$
T_j	junction temperature		–	200	$^\circ\text{C}$

THERMAL CHARACTERISTICS

SYMBOL	PARAMETER	CONDITIONS	VALUE	UNIT
$R_{th\ j-mb}$	thermal resistance from junction to mounting base	$T_{mb} \leq 85\text{ }^\circ\text{C}; P_{tot} = 5.7\text{ W}$	20.5	K/W

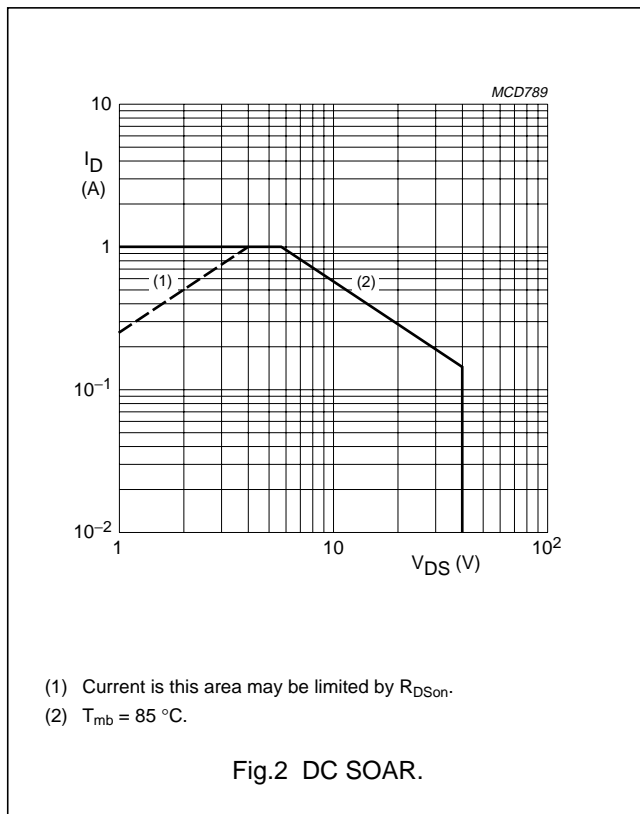

HF/VHF power MOS transistor

BLF202

CHARACTERISTICST_j = 25 °C unless otherwise specified.

SYMBOL	PARAMETER	CONDITIONS	MIN.	TYP.	MAX.	UNIT
V _{(BR)DSS}	drain-source breakdown voltage	I _D = 3 mA; V _{GS} = 0	40	–	–	V
V _{GSth}	gate-source threshold voltage	I _D = 3 mA; V _{DS} = 10 V	2	–	4.5	V
I _{DSS}	drain-source leakage current	V _{GS} = 0; V _{DS} = 12.5 V	–	–	10	μA
I _{GSS}	gate-source leakage current	V _{GS} = ±20 V; V _{DS} = 0	–	–	1	μA
I _{DSX}	on-state drain current	V _{GS} = 15 V; V _{DS} = 10 V	–	1.3	–	A
R _{DSon}	drain-source on-state resistance	I _D = 0.3 A; V _{GS} = 15 V	–	3.5	4	Ω
g _{fs}	forward transconductance	I _D = 0.3 A; V _{DS} = 10 V	80	135	–	mS
C _{is}	input capacitance	V _{GS} = 0; V _{DS} = 12.5 V; f = 1 MHz	–	5.3	–	pF
C _{os}	output capacitance	V _{GS} = 0; V _{DS} = 12.5 V; f = 1 MHz	–	7.8	–	pF
C _{rs}	feedback capacitance	V _{GS} = 0; V _{DS} = 12.5 V; f = 1 MHz	–	1.8	–	pF

V_{GS} group indicator

GROUP	LIMITS (V)		GROUP	LIMITS (V)	
	MIN.	MAX.		MIN.	MAX.
A	2.0	2.1	O	3.3	3.4
B	2.1	2.2	P	3.4	3.5
C	2.2	2.3	Q	3.5	3.6
D	2.3	2.4	R	3.6	3.7
E	2.4	2.5	S	3.7	3.8
F	2.5	2.6	T	3.8	3.9
G	2.6	2.7	U	3.9	4.0
H	2.7	2.8	V	4.0	4.1
J	2.8	2.9	W	4.1	4.2
K	2.9	3.0	X	4.2	4.3
L	3.0	3.1	Y	4.3	4.4
M	3.1	3.2	Z	4.4	4.5
N	3.2	3.3			

HF/VHF power MOS transistor

BLF202

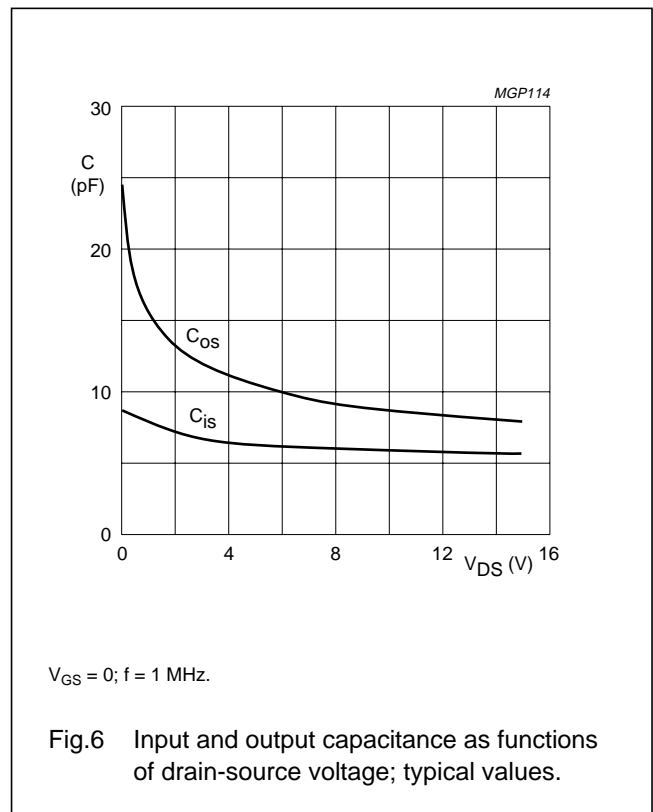
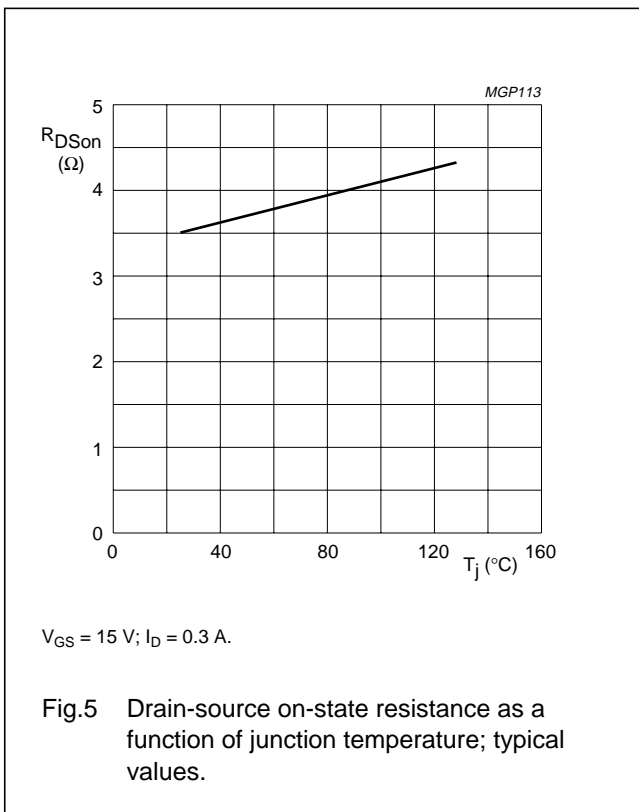
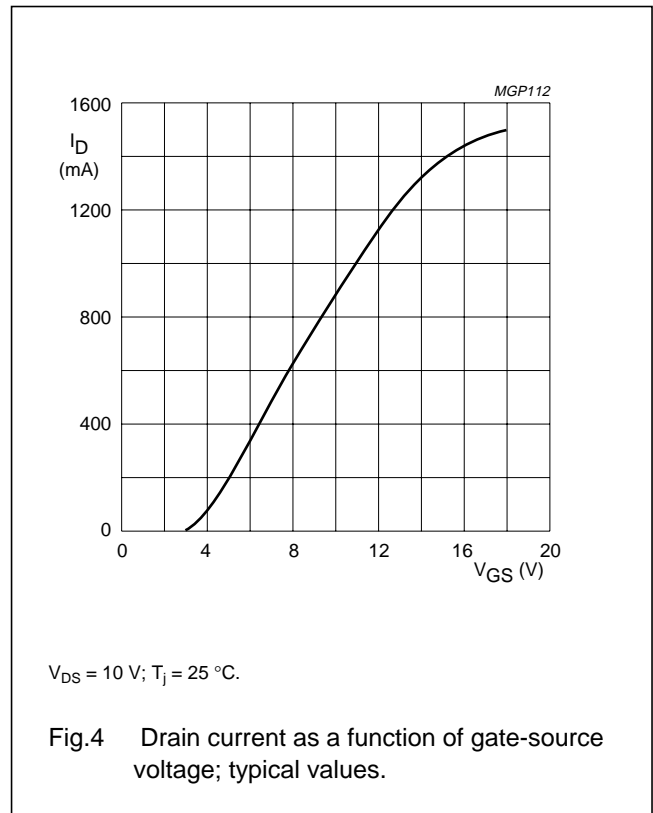
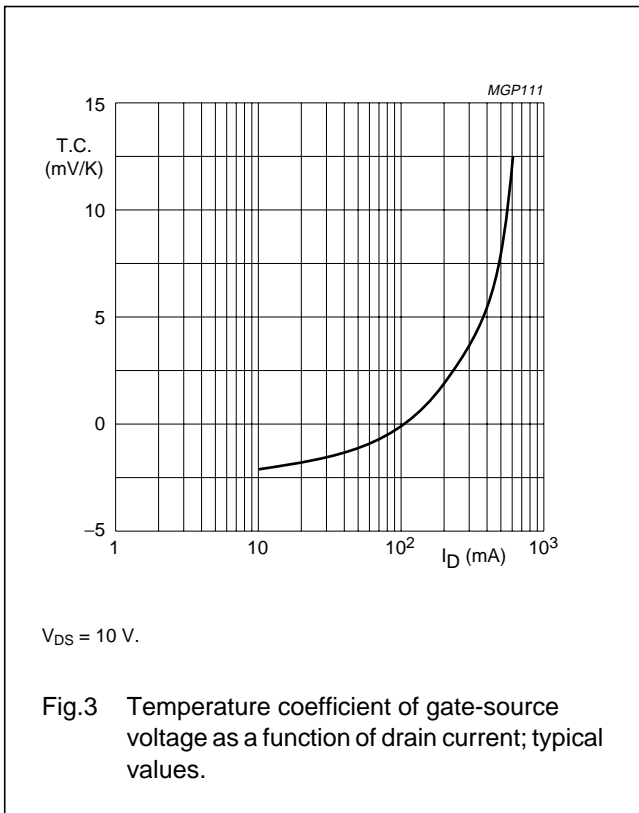

HF/VHF power MOS transistor

BLF202

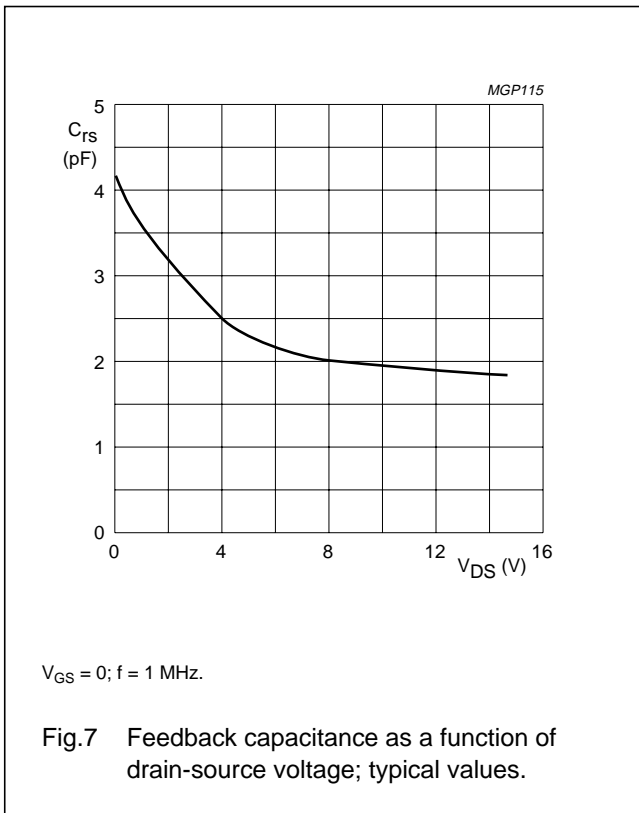

APPLICATION INFORMATION FOR CLASS-B OPERATION

$T_{mb} = 25$ °C; $R_{GS} = 237$ Ω ; unless otherwise specified.

RF performance in CW operation in a common source class-B test circuit.

MODE OF OPERATION	f (MHz)	V_{DS} (V)	I_{DQ} (mA)	P_L (W)	G_p (dB)	η_D (%)
CW, class-B	175	12.5	20	2	>10 typ. 13	>50 typ. 55

Ruggedness in class-B operation

The BLF202 is capable of withstanding a load mismatch corresponding to VSWR = 50:1 through all phases under the following conditions: $V_{DS} = 15.5$ V; $f = 175$ MHz at rated load power.

HF/VHF power MOS transistor

BLF202

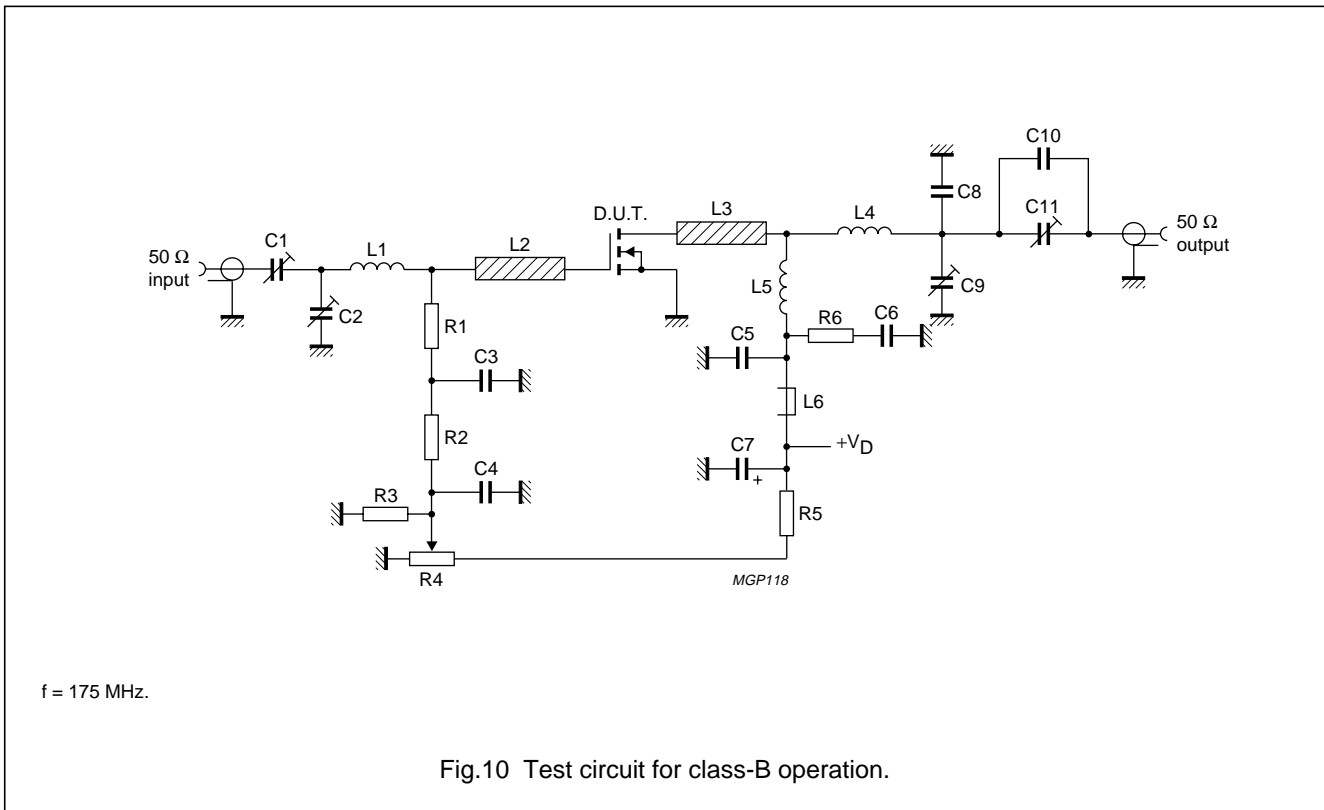
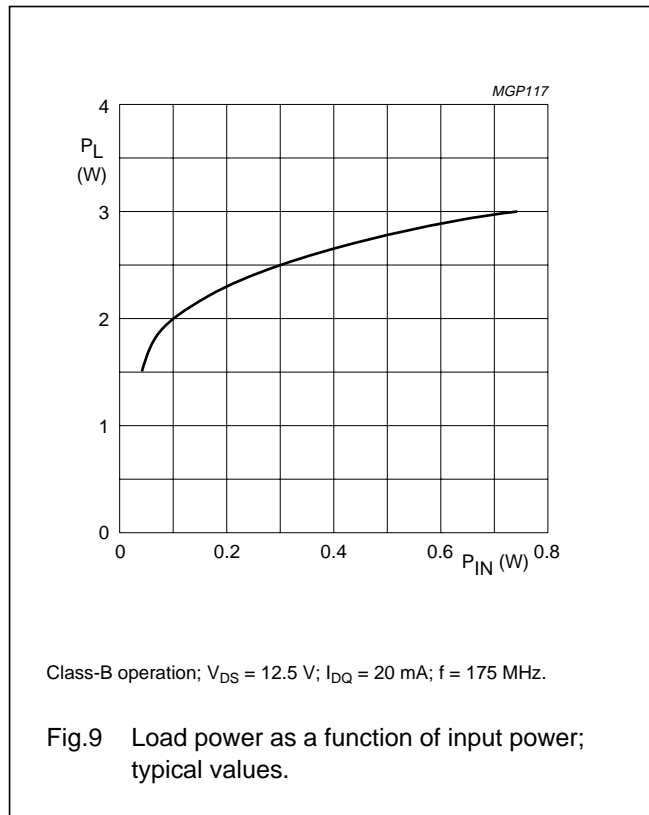
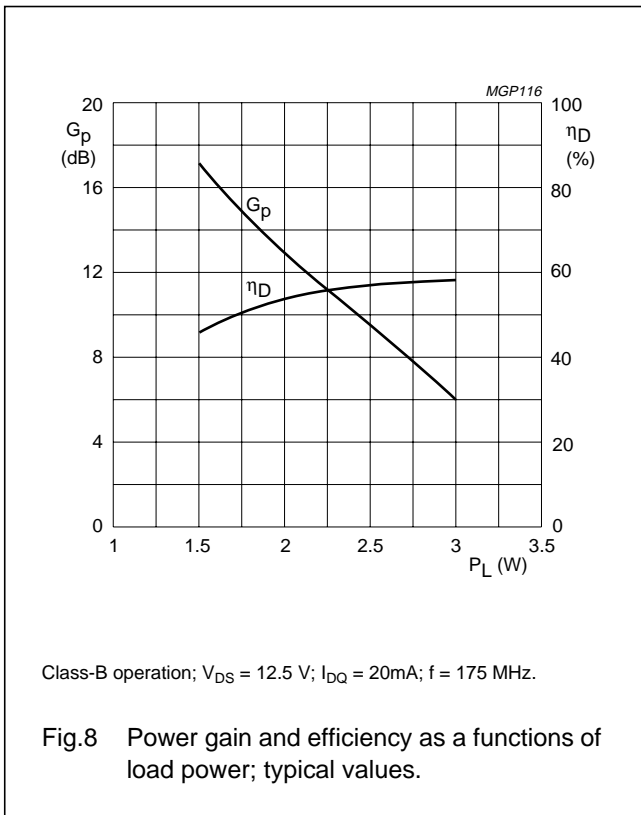

HF/VHF power MOS transistor

BLF202

List of components (see Fig.10)

COMPONENT	DESCRIPTION	VALUE	DIMENSIONS	CATALOGUE NO.
C1, C11	film dielectric trimmer	2 to 9 pF		2222 809 09005
C2, C9	film dielectric trimmer	2 to 9 pF		2222 809 09002
C3, C5	multilayer ceramic chip capacitor; note 1	1 nF; 500 V		
C4, C6	multilayer ceramic chip capacitor	2 × 100 nF in parallel, 50 V		2222 852 47104
C7	Sprague electrolytic tantalum capacitor	2.2 μF; 35 V		
C8	multilayer ceramic chip capacitor; note 1	5.1 pF; 500 V		
C10	multilayer ceramic chip capacitor; note 1	9.1 pF; 500 V		
L1	8 turns enamelled 0.8 mm copper wire	137 nH	length 5.1 mm; int. dia. 4 mm; leads 2 × 5 mm	
L2, L3	stripline; note 2	81 Ω	8 mm × 2 mm	
L4	3 turns enamelled 1 mm copper wire	57 nH	length 5 mm; int. dia. 6 mm; leads 2 × 5 mm	
L5	9 turns enamelled 1 mm copper wire	355 nH	length 11 mm; int. dia. 7 mm; leads 2 × 5 mm	
L6	grade 3B Ferroxcube RF choke			4312 020 36642
R1	0.4 W metal film resistor	237 Ω		2322 151 72371
R2	0.4 W metal film resistor	1 kΩ		2322 151 71002
R3	0.4 W metal film resistor	1 MΩ		2322 151 71005
R4	10 turns cermet potentiometer	5 kΩ		
R5	0.4 W metal film resistor	7.5 kΩ		2322 151 77502
R6	1 W metal film resistor	10 Ω		2322 153 51009

Notes

- American Technical Ceramics (ATC) capacitor, type 100B or other capacitor of the same quality.
- The striplines are on a double copper-clad printed-circuit board, with PTFE fibre-glass dielectric ($\epsilon_r = 2.2$), thickness 1.6 mm.

HF/VHF power MOS transistor

BLF202

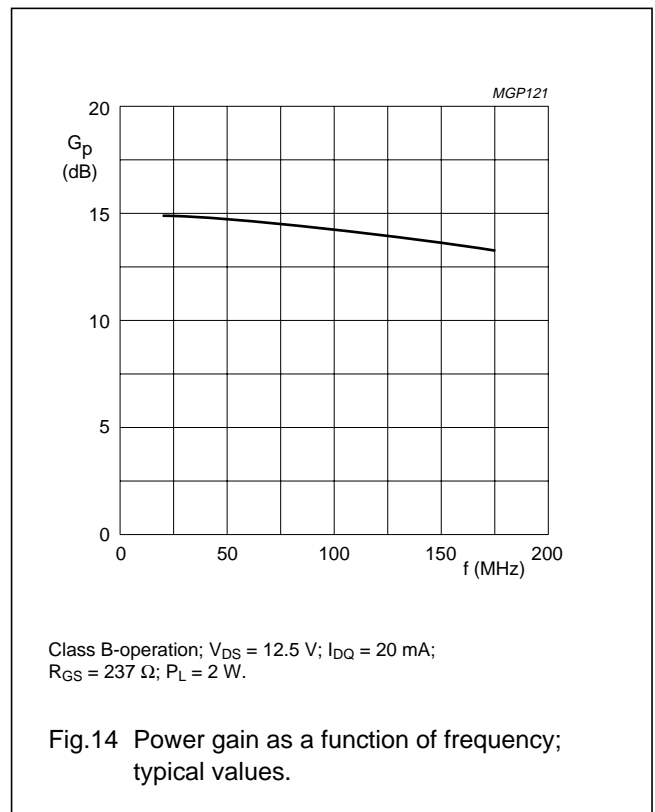
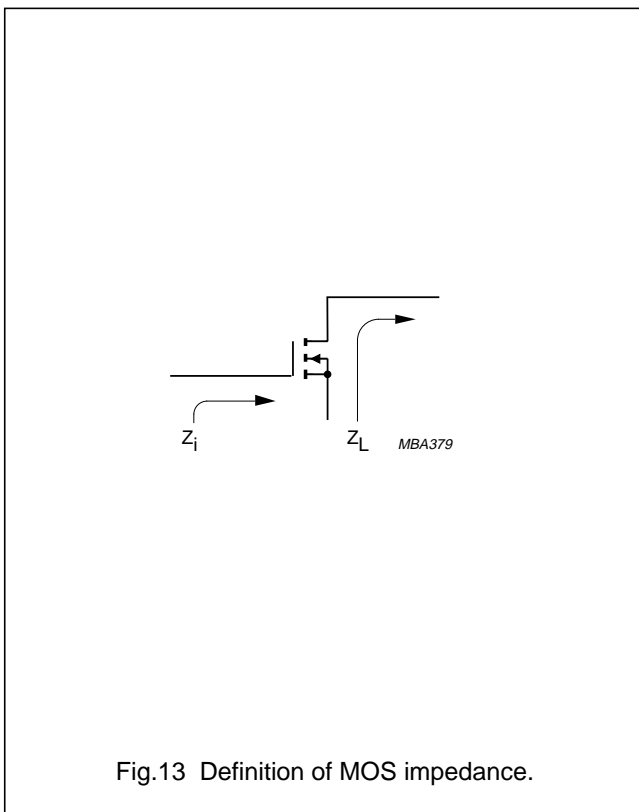
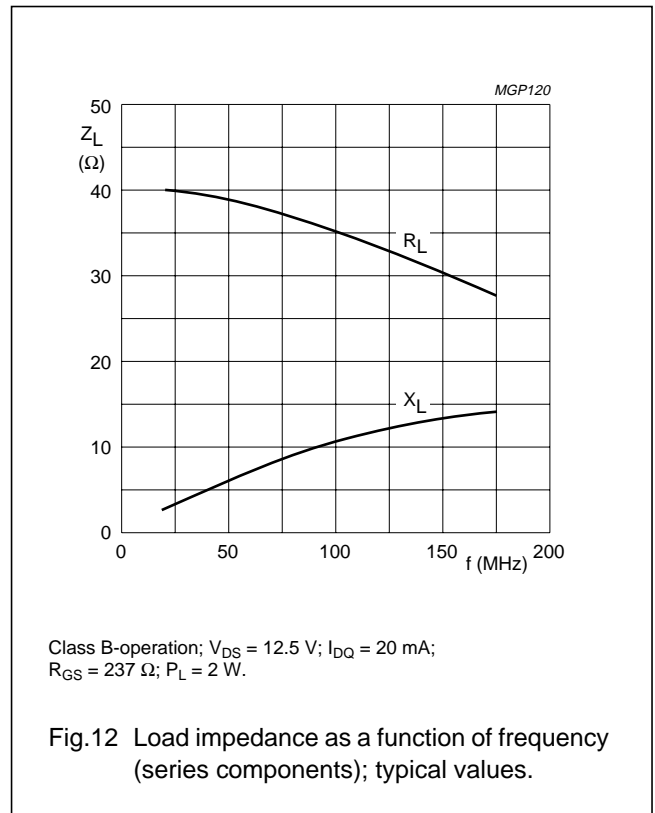
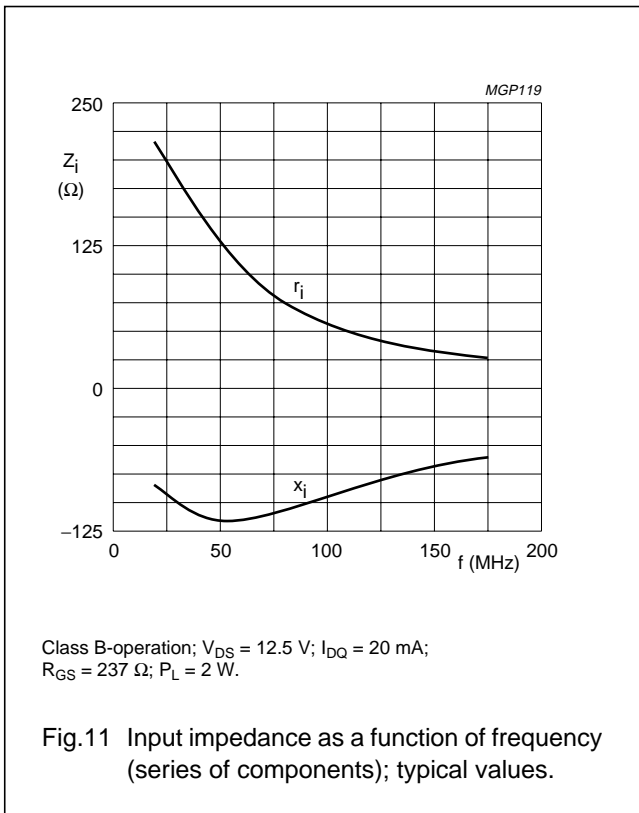

HF/VHF power MOS transistor

BLF202

MOUNTING RECOMMENDATIONS

Both the metallized ground plate and the device leads contribute to the heat flow. It is recommended that the transistor be mounted on a grounded metallized area of the printed-circuit board. This area should be of maximum 0.8 mm thickness and include at least 12 x 0.5 diameter through metallized holes filled with solder.

A thermal resistance $R_{th(mb-h)}$ of 5 K/W can be achieved if heatsink compound is applied when the transistor is mounted on the printed-circuit board.

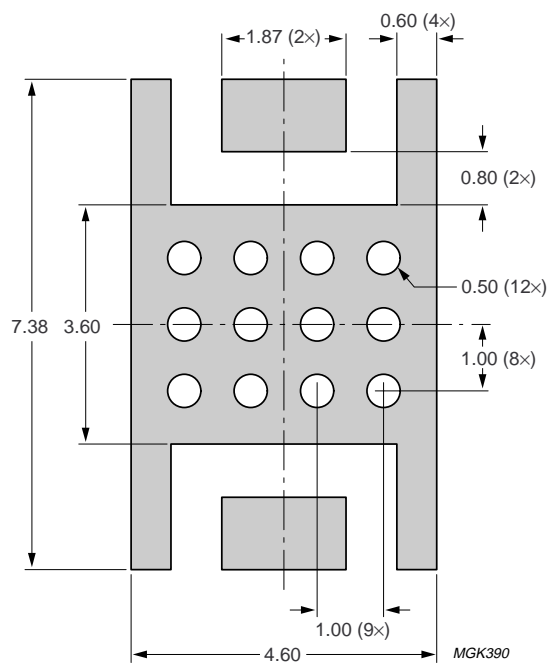

Dimensions in mm.

Fig.15 Footprint SOT409A.

HF/VHF power MOS transistor

BLF202

BLF202 scattering parameters $V_{DS} = 12.5\text{ V}$; $I_D = 20\text{ mA}$; note 1

f (MHz)	S ₁₁		S ₂₁		S ₁₂		S ₂₂	
	S ₁₁	∠ Φ	S ₂₁	∠ Φ	S ₁₂	∠ Φ	S ₂₂	∠ Φ
5	1.00	-2.00	5.76	178.30	0.01	88.30	0.97	-2.40
10	1.00	-4.00	5.75	176.50	0.01	86.70	0.97	-4.90
20	1.00	-7.90	5.72	172.90	0.02	83.40	0.97	-9.70
30	0.99	-11.90	5.69	169.40	0.03	80.20	0.97	-14.50
40	0.99	-15.80	5.65	165.90	0.04	77.00	0.96	-19.30
50	0.98	-19.60	5.58	162.40	0.05	73.80	0.96	-23.90
60	0.97	-23.40	5.51	159.00	0.06	70.70	0.95	-28.50
70	0.96	-27.00	5.42	-155.70	0.07	67.70	0.94	-33.00
80	0.94	-30.70	5.33	152.40	0.08	64.80	0.93	-37.40
90	0.93	-34.10	5.23	149.30	0.09	62.00	0.92	-41.60
100	0.92	-37.50	5.12	146.40	0.10	59.40	0.92	-45.60
125	0.89	-45.60	4.86	139.30	0.12	53.10	0.89	-55.30
150	0.85	-53.00	4.58	132.60	0.13	47.20	0.87	-64.10
175	0.82	-59.80	4.29	126.60	0.14	42.00	0.85	-72.00
200	0.79	-66.00	4.03	121.20	0.15	37.70	0.83	-79.20
250	0.74	-77.00	3.55	111.30	0.17	29.30	0.79	-91.70
300	0.70	-86.30	3.15	103.30	0.17	23.10	0.77	-101.90
350	0.68	-94.30	2.80	96.00	0.18	17.30	0.76	-110.30
400	0.66	-101.40	2.52	89.80	0.18	12.90	0.75	-117.20
450	0.64	-107.80	2.27	83.80	0.18	8.60	0.74	-123.20
500	0.64	-113.50	2.07	78.80	0.18	5.20	0.74	-128.30
600	0.63	-123.80	1.75	69.60	0.17	-0.70	0.74	-136.60
700	0.64	-132.60	1.51	61.40	0.15	-5.30	0.75	-143.20
800	0.65	-140.60	1.32	54.40	0.14	-8.20	0.76	-148.60
900	0.67	-148.10	1.16	48.20	0.12	-9.70	0.77	-153.30
1000	0.68	-155.00	1.04	42.90	0.11	-9.20	0.78	-157.40

Note

1. For more extensive s-parameters see internet:
<http://www.semiconductors.philips.com/markets/communications/wirelesscommunications/broadcast>.

HF/VHF power MOS transistor

BLF202

PACKAGE OUTLINE

Ceramic surface mounted package; 8 leads

SOT409A

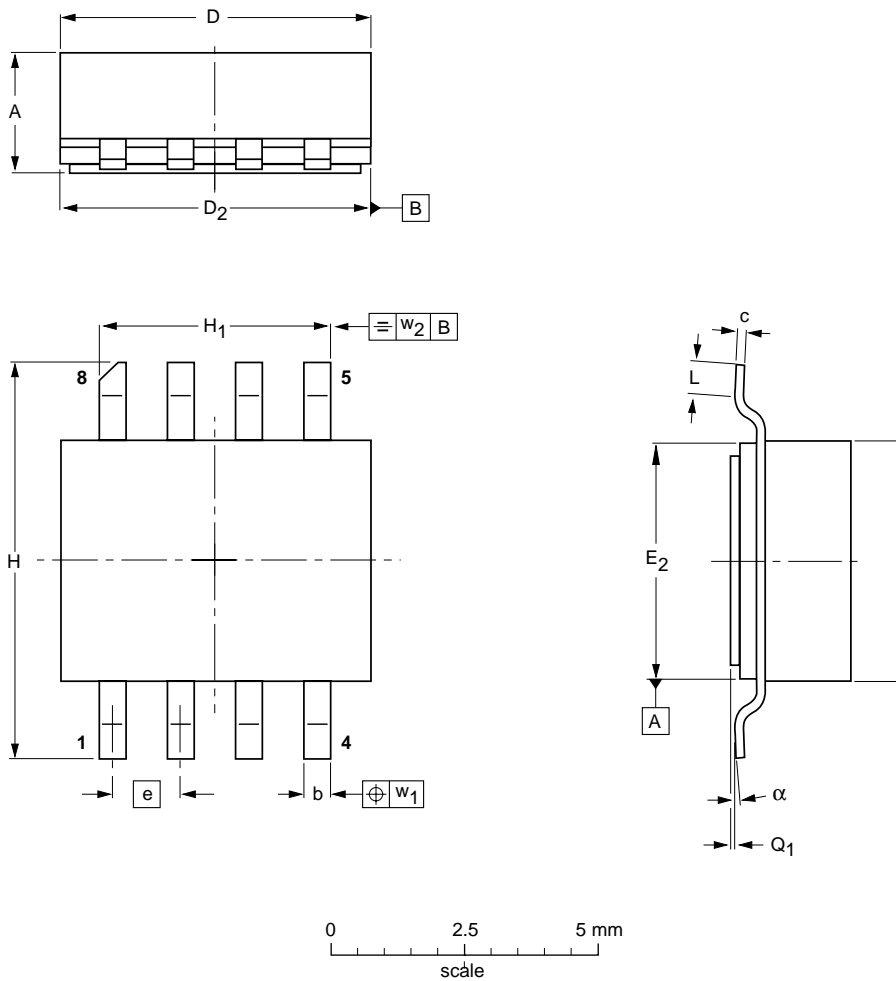

DIMENSIONS (millimetre dimensions are derived from the original inch dimensions)

UNIT	A	b	c	D	D ₂	E	E ₂	e	H	H ₁	L	Q ₁	w ₁	w ₂	α
mm	2.36 2.06	0.58 0.43	0.23 0.18	5.94 5.03	5.16 5.00	4.93 4.01	4.14 3.99	1.27	7.47 7.26	4.39 4.24	1.02 0.51	0.10 0.00	0.25	0.25	7° 0°
inches	0.093 0.081	0.023 0.017	0.009 0.007	0.234 0.198	0.203 0.197	0.194 0.158	0.163 0.157	0.050	0.294 0.286	0.173 0.167	0.040 0.020	0.004 0.000	0.010	0.010	7° 0°

OUTLINE VERSION	REFERENCES				EUROPEAN PROJECTION	ISSUE DATE
	IEC	JEDEC	EIAJ			
SOT409A						98-01-27

HF/VHF power MOS transistor

BLF202

DATA SHEET STATUS

LEVEL	DATA SHEET STATUS ⁽¹⁾	PRODUCT STATUS ⁽²⁾⁽³⁾	DEFINITION
I	Objective data	Development	This data sheet contains data from the objective specification for product development. Philips Semiconductors reserves the right to change the specification in any manner without notice.
II	Preliminary data	Qualification	This data sheet contains data from the preliminary specification. Supplementary data will be published at a later date. Philips Semiconductors reserves the right to change the specification without notice, in order to improve the design and supply the best possible product.
III	Product data	Production	This data sheet contains data from the product specification. Philips Semiconductors reserves the right to make changes at any time in order to improve the design, manufacturing and supply. Relevant changes will be communicated via a Customer Product/Process Change Notification (CPCN).

Notes

1. Please consult the most recently issued data sheet before initiating or completing a design.
2. The product status of the device(s) described in this data sheet may have changed since this data sheet was published. The latest information is available on the Internet at URL <http://www.semiconductors.philips.com>.
3. For data sheets describing multiple type numbers, the highest-level product status determines the data sheet status.

DEFINITIONS

Short-form specification — The data in a short-form specification is extracted from a full data sheet with the same type number and title. For detailed information see the relevant data sheet or data handbook.

Limiting values definition — Limiting values given are in accordance with the Absolute Maximum Rating System (IEC 60134). Stress above one or more of the limiting values may cause permanent damage to the device. These are stress ratings only and operation of the device at these or at any other conditions above those given in the Characteristics sections of the specification is not implied. Exposure to limiting values for extended periods may affect device reliability.

Application information — Applications that are described herein for any of these products are for illustrative purposes only. Philips Semiconductors make no representation or warranty that such applications will be suitable for the specified use without further testing or modification.

DISCLAIMERS

Life support applications — These products are not designed for use in life support appliances, devices, or systems where malfunction of these products can reasonably be expected to result in personal injury. Philips Semiconductors customers using or selling these products for use in such applications do so at their own risk and agree to fully indemnify Philips Semiconductors for any damages resulting from such application.

Right to make changes — Philips Semiconductors reserves the right to make changes in the products - including circuits, standard cells, and/or software - described or contained herein in order to improve design and/or performance. When the product is in full production (status 'Production'), relevant changes will be communicated via a Customer Product/Process Change Notification (CPCN). Philips Semiconductors assumes no responsibility or liability for the use of any of these products, conveys no licence or title under any patent, copyright, or mask work right to these products, and makes no representations or warranties that these products are free from patent, copyright, or mask work right infringement, unless otherwise specified.

Philips Semiconductors – a worldwide company

Contact information

For additional information please visit <http://www.semiconductors.philips.com>. Fax: +31 40 27 24825

For sales offices addresses send e-mail to: sales.addresses@www.semiconductors.philips.com.

© Koninklijke Philips Electronics N.V. 2003

SCA75

All rights are reserved. Reproduction in whole or in part is prohibited without the prior written consent of the copyright owner.

The information presented in this document does not form part of any quotation or contract, is believed to be accurate and reliable and may be changed without notice. No liability will be accepted by the publisher for any consequence of its use. Publication thereof does not convey nor imply any license under patent- or other industrial or intellectual property rights.

Printed in The Netherlands

613524/02/pp14

Date of release: 2003 Sep 19

Document order number: 9397 750 11595

Let's make things better.

**Philips
Semiconductors**



PHILIPS