

Ultra Rapid Semiconductor Protection Fuse

European Square Body Fuses 690V

















German Standard DIN 80
Voltage Rating - 690V
Current Ratings from 16A to 450A
aR Characteristics
Size 00



Key Features:

- ❖ Extremely high breaking capacity fuses for the protection of power semiconductors as per IEC Standard 60269.1 and 4.
- ❖ 690V voltage rating complying with IEC 33
- ❖ Non Magnetic construction
- ❖ gRB Characteristics with ratings from 16 to 125A in accordance with VDE 636-23
 - Clearing all overloads
 - Improving safety and protection
 - Enabling selective co-ordination with all fuses
- ❖ All models available with or without integrated trip indicator
- ❖ Microswitch MS 4L 2-5 B6
- ❖ Fuse holder SI 00 DIN80

Main Characteristics:

Size	Voltage U _N (V)	Ref:	Micro Switch		Current rating I _N (A)	Pre-arcing I ² t @ 1 ms I ² t _p (A ² s)	Total Clearing I ² t @ U _N (A ² s)	Power Losses 0.8I _N I _N		Tested Interrupting rating
00	690V	069GUDA0016F	Y		16	7	52	3.8	7	200kA @ 690V
		069GUDA0020F	Y		20	10	75	5	9	
		069GUDA0025F	Y		25	15	120	6	11	
		069GUDA0032F	Y		32	32	210	8.2	15	
		069GUDA0040F	Y		40	61	400	9.9	18	
		069GUDA0050F	Y		50	102	700	11.5	21	
		069GUDA0063F	Y		63	177	1200	12.6	23	
		069GUDA0080F	Y		80	390	2200	13.8	25	
		069GUDA0100F	Y		100	692	3900	15.4	28	
		069GUDA0125F	Y		125	1170	6600	18.1	33	
		069GUDA0160F	Y		160	2680	14000	19.8	36	
		069GUDA0200F	Y		200	4690	24000	23.1	42	
		069GUDA0250F	Y		250	8300	42500	27.5	50	
		069GUDA0315F	Y		315	17520	81000	31.9	58	
		069GUDA0350F	Y		350	25450	118000	33	60	
		069GUDA0400F	Y		400	33200	150000	38.5	70	
600V	060GUDA0450F	Y		450	19600	225000	40.7	74	200kA @ 600V	

Notes: Minimum operating voltage for integrated trip indicator = 20V

Micro switch reference : MS 4L 2-5 B6 

Electrical Characteristics:

Times vs Current Characteristics:

These curves indicate, for each rated current, the pre-arcing time vs. the RMS pre-arcing current. Tolerance for the mean pre-arcing current $\pm 8\%$

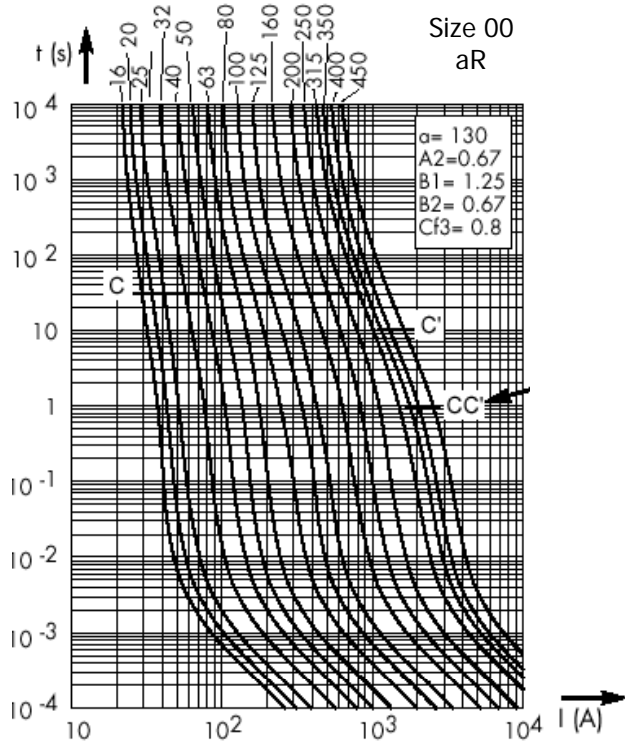

Total Clearing I^2t :

The horizontal curves show, for each rated current, values of total clearing $I^2t (I^2t_t)$ as a function of prospective current $I_p @ U_N$ with $\cos\phi = 0.15$. Oblique lines indicate total clearing duration Tt , with associated pre-arcing duration in brackets.

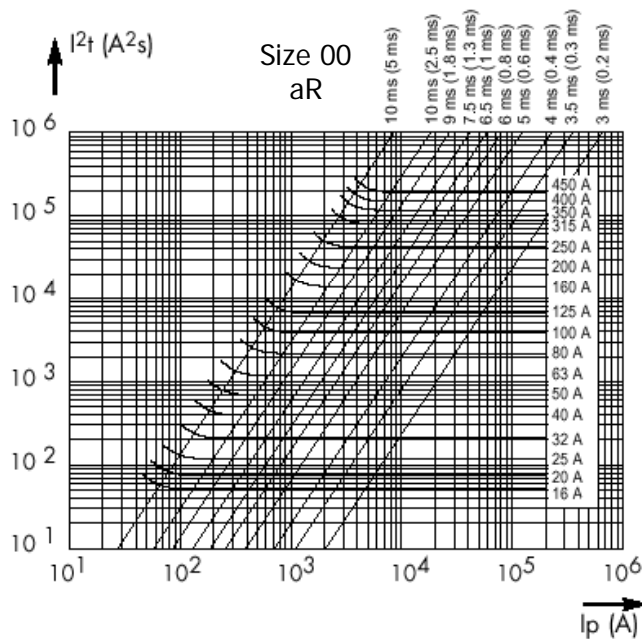

Cut off Characteristics:

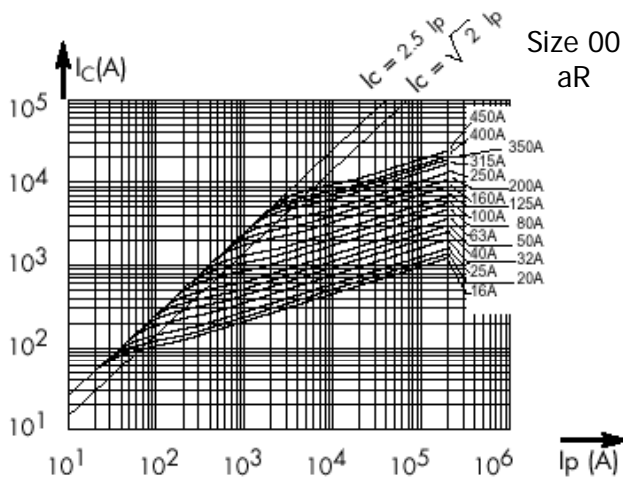

Curves show for each current rating value of peak let-through current I_c as a function of available fault current I_p

Corrective Factor:

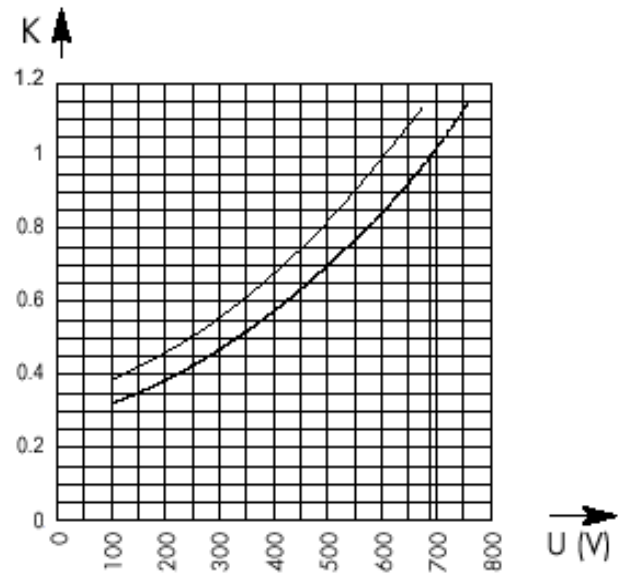

Mean curves show variation of total clearing time ($I^2 t_t$) and total clearing duration T_t as a function of operating voltage U .

Peak Arc Voltage:

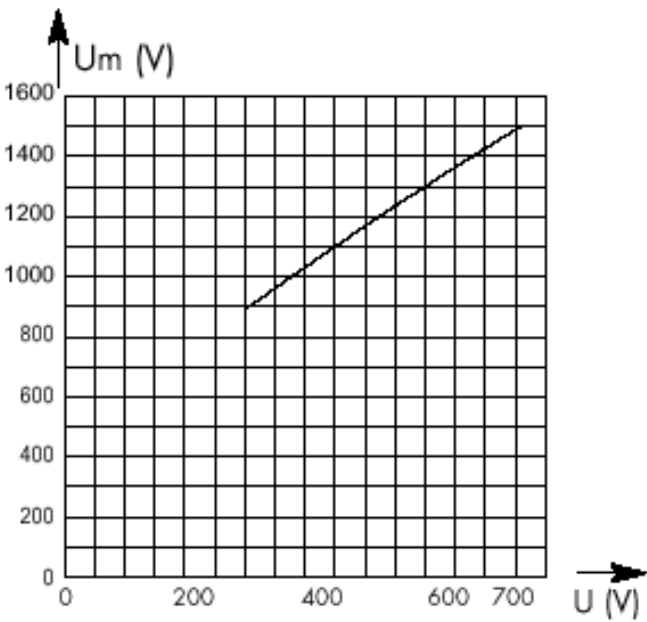

Curve shows peak value U_m of arc voltage which appears across fuse link as a function of the operating voltage $U @ \cos \varphi = 0.15$

Dissipated Power:

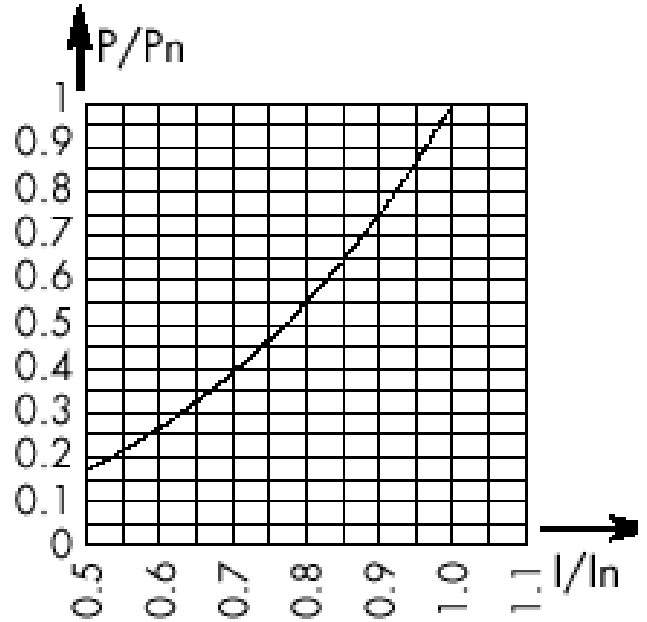

Curve enables computation of power losses P for a I_N -rated fuse as a function of RMS current I (as a multiple of I_N for steady state operation).

Outline Drawing & Ordering Information:

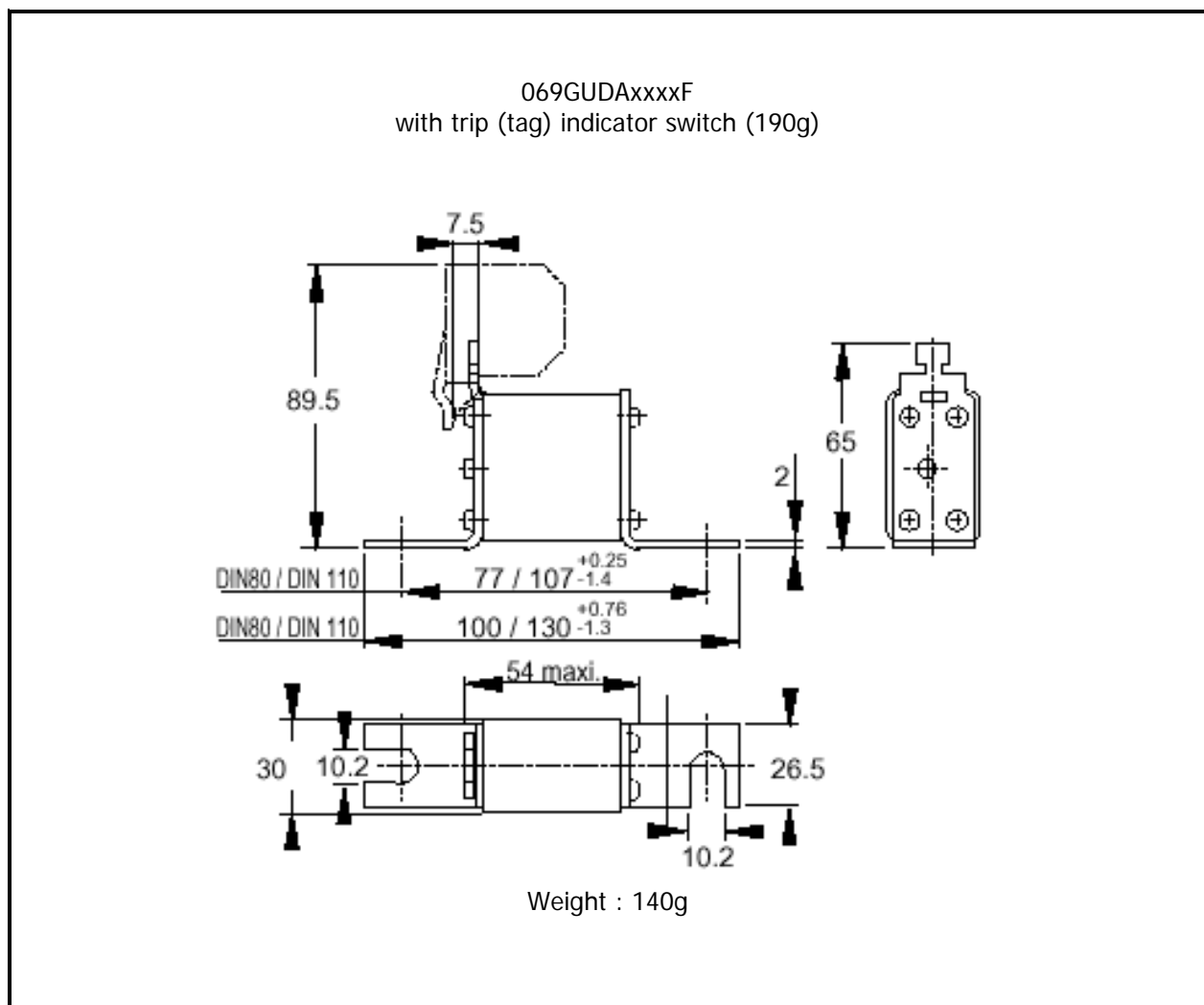

ORDERING INFORMATION

(Please quote code as below)

Voltage Rating (V)	Type	Size	Fixing	Current Rating (A)	Trip Indicator
690	GU	D	A	16 to 450	F

Order code: e.g. **069GUDA0050F** = 690V German Standard, Size 00, 80mm fixing, 50amp fuse with trip (tag) indicator switch

IXYS Semiconductor GmbH
Edisonstraße 15
D-68623 Lampertheim
Tel: +49 6206 503-0
Fax: +49 6206 503-627
E-mail: marcom@ixys.de

WESTCODE
An IXYS Company

Westcode Semiconductors Ltd
Langley Park Way Langley Park
Chippenham Wiltshire SN15 1GE
Tel: +44 (0)1249 444524
Fax: +44 (0)1249 659448
E-mail: WSL.sales@westcode.com

IXYS Corporation
3540 Bassett Street
Santa Clara CA 95054 USA
Tel: +1 (408) 982 0700
Fax: +1 (408) 496 0670
E-mail: sales@ixys.com

www.westcode.com

www.ixys.com

Westcode Semiconductors Inc
3270 Cherry Avenue
Long Beach CA 90807 USA
Tel: +1 (562) 595 6971
Fax: +1 (562) 595 8182
E-mail: WSI.sales@westcode.com

The information contained herein is confidential and is protected by Copyright. The information may not be used or disclosed except with the written permission of and in the manner permitted by the proprietors Westcode Semiconductors Ltd.

© Westcode Semiconductors Ltd.

In the interest of product improvement, Westcode reserves the right to change specifications at any time without prior notice.