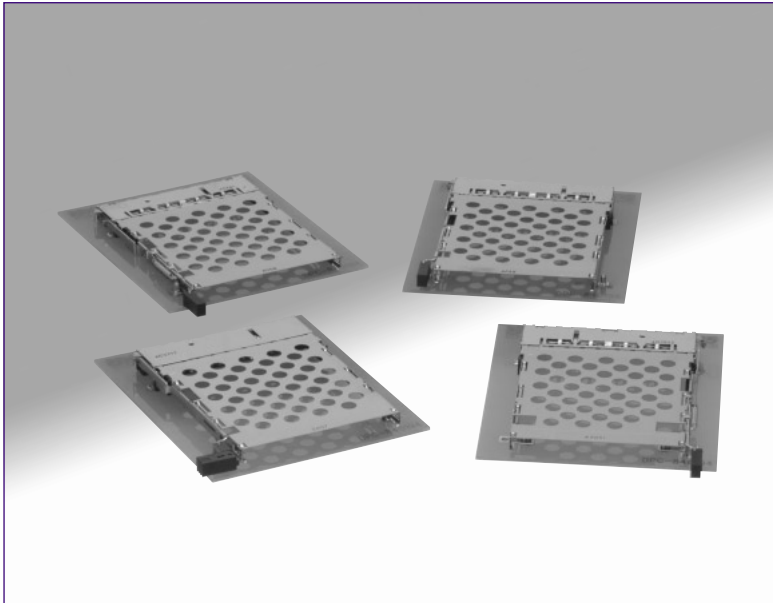


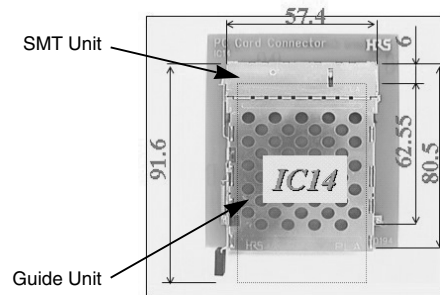
# Single Slot SMT Connectors for Card-Bus Based PC Cards

IC14 Series

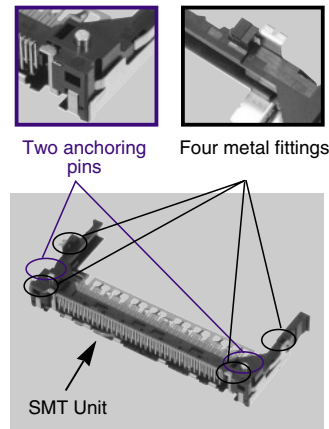
PC Card Standard Compliant



## Board Space-Saving



## Secure board retention



## Features

### 1. Space-Saving design facilitates pattern routing

Responding to the need for the equipment miniaturization, the board mounting area has been further reduced by relocation of the mounting screws away from the possible routing of the conductive traces.

### 2. Card insertion shock protection

Total of 6 board retention points assures that there is no transfer of card insertion forces to the solder terminations.

### 3. New “Pop-Up” button card ejection mechanism

The button does not protrude without the card being inserted, preventing it's damage when carrying the notebook computer.

### 4. Customized ejection buttons

The configuration, color or length can be designed for customer's specific applications.

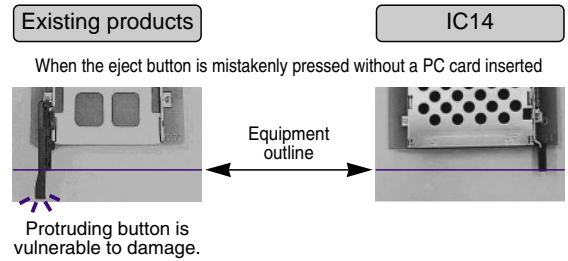
### 5. Reliable and balanced card ejection mechanism

Hirose's unique ejection mechanism will apply force equally at each edge of the inserted card. In addition, large distance of the ejection allows easy hold on the card.

## Applications

Notebook PCs, audio/video equipment and other devices utilizing PC cards.

## Three-stage “Pop-Up” card ejection mechanism



Board mounting	Standoff	Eject button	
		Left	Right
Standard	1.5mm	Left	Pop-up
		Left	Folding
		Left	Rigid
		Right	Pop-up
	2.2mm	Left	Pop-up
		Right	Pop-up
Reverse	2.2mm	Left	Pop-up
		Left	Folding
		Left	Rigid
		Right	Pop-up
	2.2mm	Right	Pop-up
		Right	Pop-up

## ■Product Specifications

Ratings	Current rating	0.5A	Operating temperature range	-55°C to +85°C (Note 1)	Storage temperature range	-40°C to +70°C (Note 2)
	Voltage rating	125V AC	Operating humidity range	Relative humidity 95% max. (No condensation)	Storage humidity range	40% to 70% (Note 2)

Item	Specifications	Conditions
1. Insulation resistance	1000 MΩ min.	500 V DC
2. Withstanding voltage	No flashover or insulation breakdown.	500 V AC / one minute
3. Contact resistance	60 mΩ max. (Initial value)	1mA DC
4. Vibration	No electrical discontinuity of 100 ns or more.	Frequency: 10 to 2000 Hz, single amplitude of 1.52 mm or acceleration of 147m/s <sup>2</sup> (peak), 4 hours / 3 axis
5. Humidity	Insulation resistance: 100 MΩ min.	96 hours at temperature of 40°C±2°C and humidity of 90% to 95%
6. Temperature cycle	Insulation resistance: 100 MΩ min.	Temperature: -55°C → +5°C to +35°C → +85°C → +5°C to +35°C Duration: 30 → 5 max. → 30 → 5 max. (Minutes) 5 cycles
7. Durability (mating/unmating)	Contact resistance: 20mΩ max. from initial value	10000 cycles at 400 to 600 cycles per hour
8. Resistance to soldering heat	No deformation of any component. No affect on contacts.	Reflow: At the recommended temperature profile Manual soldering: 300°C for 3 seconds

Note 1: Includes temperature rise caused by current flow.

Note 2: The term "storage" refers to products stored for long period of time prior to mounting and use. Operating Temperature Range and Humidity range covers non- conducting condition of installed connectors in storage, shipment or during transportation.

## ■Materials/Finish

### SMT unit

Component	Material	Finish	Remarks
Insulator	Heat resistant thermoplastic compound	Color: Black	UL94V-0
Contacts	Brass	Contact area: Gold plated Termination area: Tin-lead plated (Note)	—
Ground/eject metal fittings	Stainless	—	—
Positioning pin	Brass	Tin-lead plated (Note)	—

### Guide unit

Component	Material	Finish	Remarks
Insulator	PBT	Color: Black	UL94V-0
Cover/Eject metal fittings	Stainless	—	—
Spring	Steel	—	—

Note: Lead-free specified connectors are tin plated.

## ■ Ordering information

### ● SMT unit

IC14 A - PLR - SF - EJR -(71)  
 ①    ②            ③            ④            ⑤            ⑥

① Series name : IC14	④ SF : SMT unit
② Standoff type Blank : 0 mm A : 2.2 mm B : 1.5 mm	⑤ Eject button position EJR : Right-side eject EJL : Left-side eject Number of ground contacts
③ Board mounting type PL: Standard type PLR: Reverse type	⑥ Product specification code Blank : Tin-lead plated (71): Lead-free plated

### ● Guide unit

IC14 A - G - P EJR  
 ⑦    ⑧            ⑨            ⑩            ⑪

⑦ Series name : IC14	⑩ Eject button type Blank : Rigid button P : Pop-up button F : Folding button
⑧ Standoff type Blank : 0 mm A : 2.2 mm B : 1.5 mm (Note 1)	⑪ Eject button position EJR: Right-side eject EJL: Left-side eject
⑨ G: Guide unite	

Note 1: In the IC14B type, the screw attachment holes in the Guide unit are not threaded.

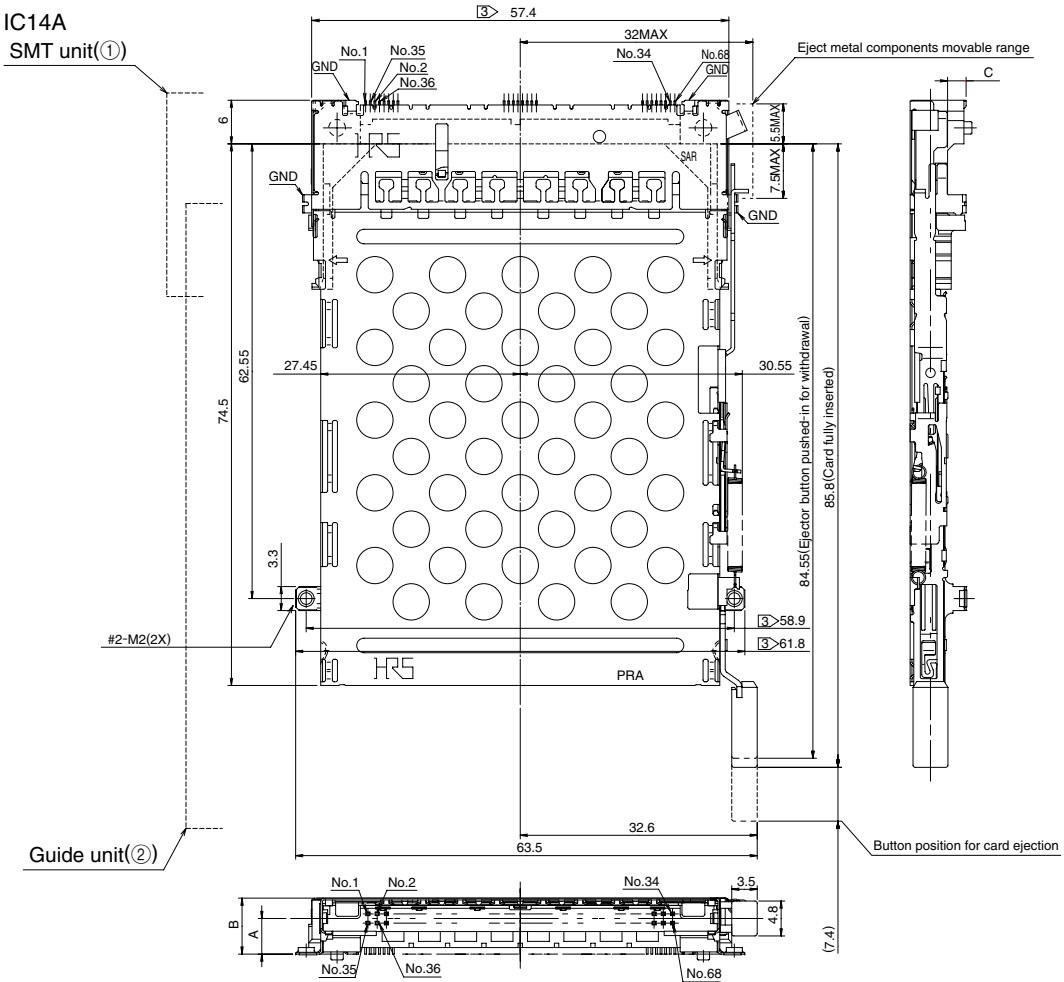
Note 2: In this series the SMT unit and the Guide unit must be used in combinations shown below.

Other combinations cannot be used.

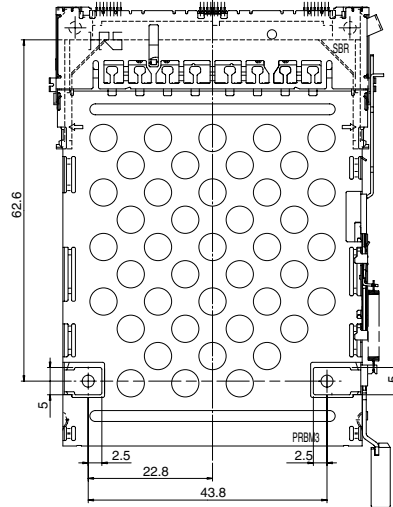
- \* Series name ( ① ↔ ⑦ )
- \* Standoffs ( ② ↔ ⑧ )
- \* Ejection button position ( ⑤ ↔ ⑪ )

# Standard Right Pop-up button

● IC14, IC14A



● IC14B



Stand off height	SMT unit ①		Guide unit ②		A (mm)	B (mm)	C (mm)	Weight (g)
	Part Number	CL No.	Part Number	CL No.				
	IC14-PL-SF-EJR	CL640-1301-0	IC14-G-PEJR	CL640-1409-7	2.7	5.5	0.3	13.1
2.2mm	IC14A-PL-SF-EJR	CL640-1303-6	IC14A-G-PEJR	CL640-1411-9	4.9	7.7	2.5	13.5
1.5mm	IC14B-PL-SF-EJR	CL640-1309-2	IC14B-G-PEJR	CL640-1413-4	4.2	7	1.8	13.3

1 : All illustrations show the SMT unit (①) and Guide unit (②) assembled.

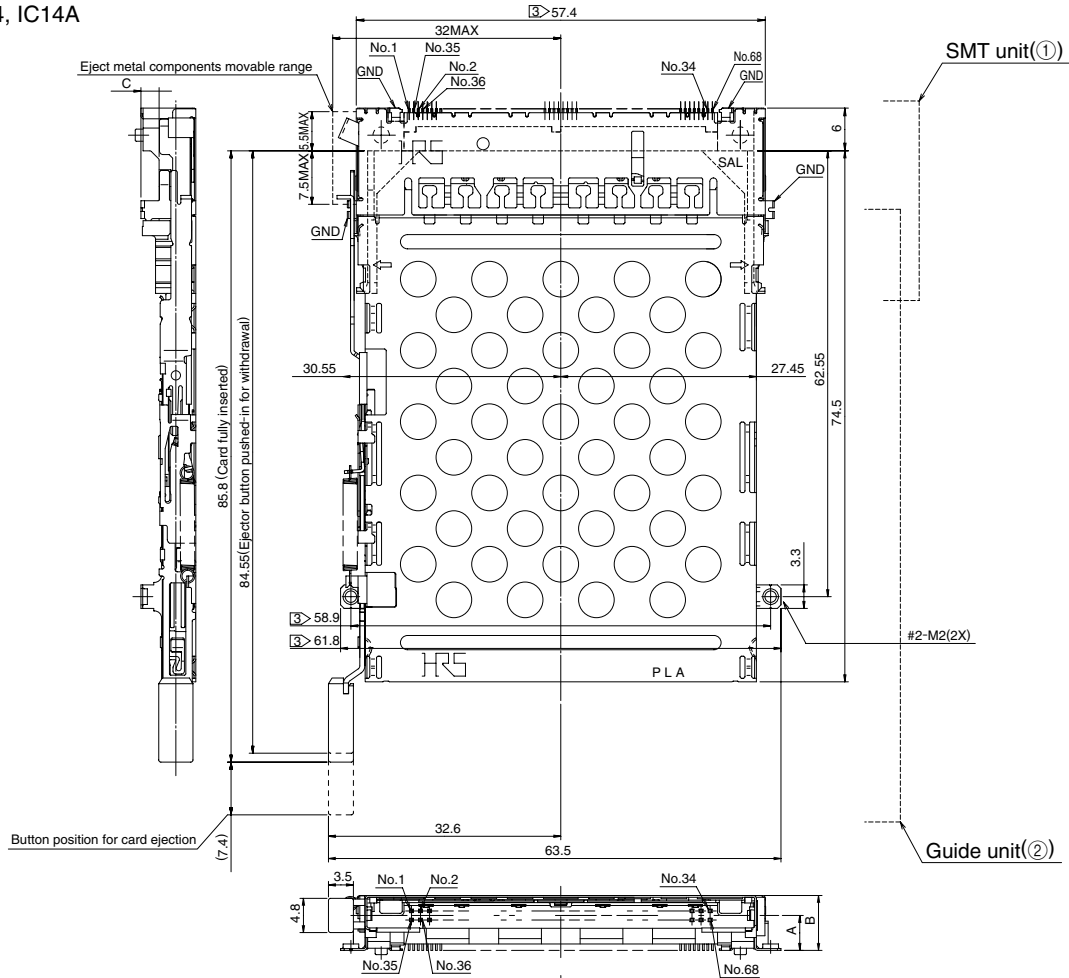
2 : Dimensions for card insertion are in accordance with "PC card standard".

③ : Indicated dimensions are symmetrical to the center of the card insertion slot.

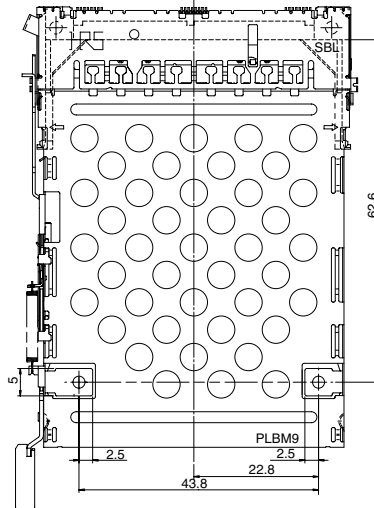
# Standard

## Left Pop-up button

● IC14, IC14A



● IC14B



Stand off height	SMT unit ①		Guide unit ②		A (mm)	B (mm)	C (mm)	Weight (g)
	Part Number	CL No.	Part Number	CL No.				
	IC14-PL-SF-EJL	CL640-1302-3	IC14-G-PEJL	CL640-1410-6	2.7	5.5	0.3	13.1
2.2mm	IC14A-PL-SF-EJL	CL640-1304-9	IC14A-G-PEJL	CL640-1412-1	4.9	7.7	2.5	13.5
1.5mm	IC14B-PL-SF-EJL	CL640-1310-1	IC14B-G-PEJL	CL640-1414-7	4.2	7	1.8	13.3

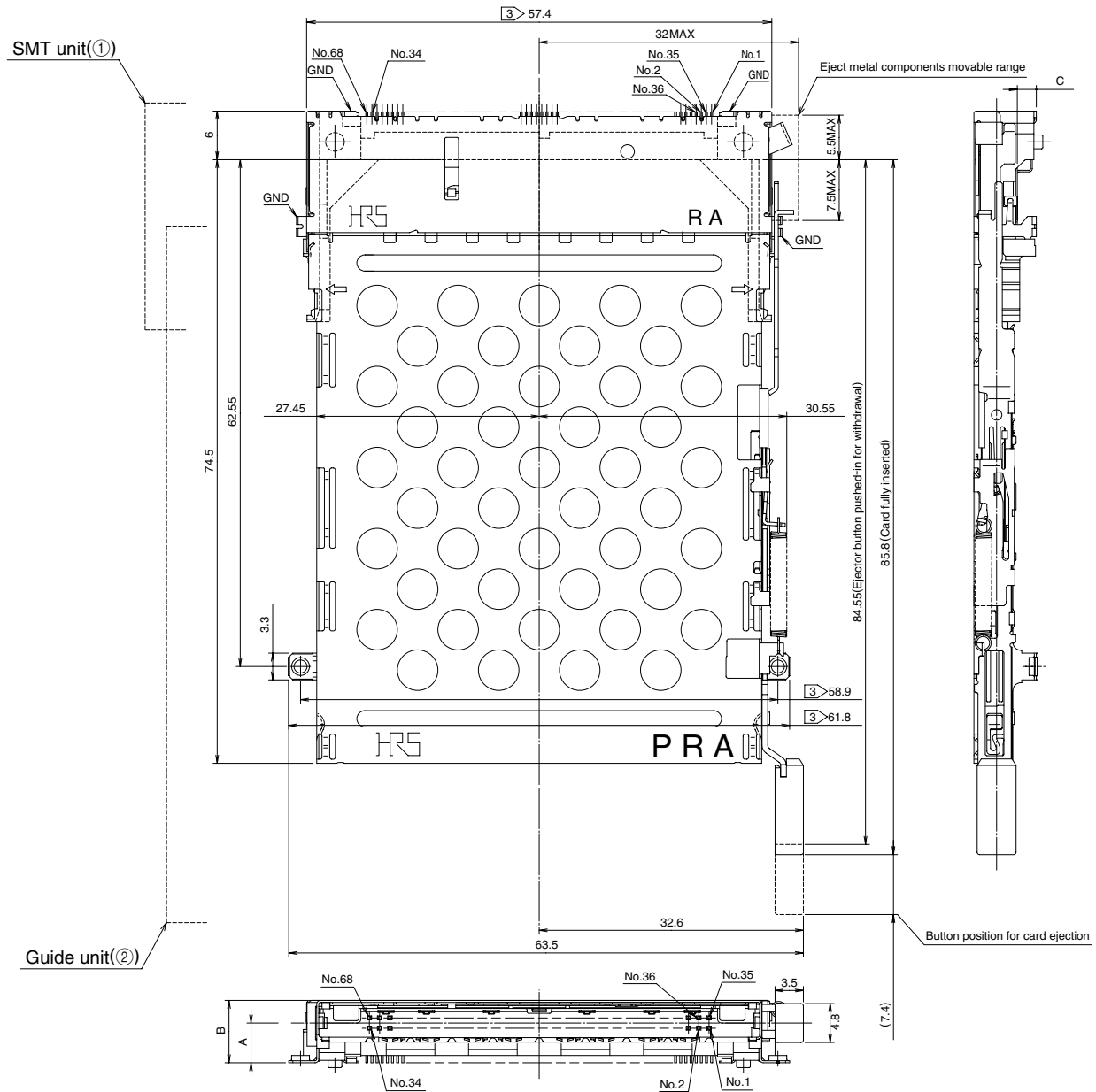
1 : All illustrations show the SMT unit (①) and Guide unit (②) assembled.

2 : Dimensions for card insertion are in accordance with "PC card standard".

③ : Indicated dimensions are symmetrical to the center of the card insertion slot.

# Reverse

## Right Pop-up button

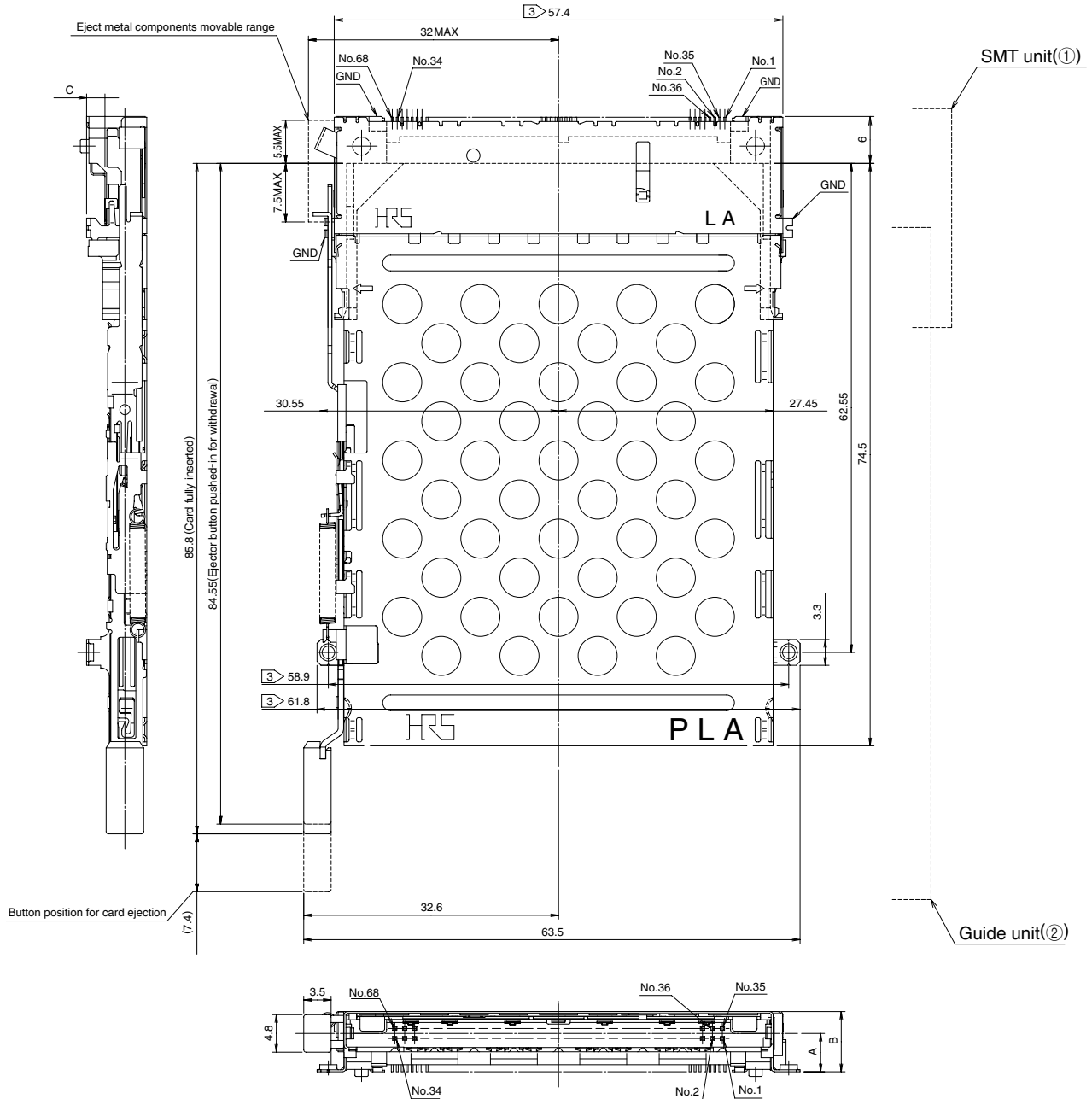


Stand off height	SMT unit ①		Guide unit ②		A (mm)	B (mm)	C (mm)	Weight (g)
	Part Number	CL No.	Part Number	CL No.				
2.2mm	IC14A-PLR-SF-EJR	CL640-1307-7	IC14A-G-PEJR	CL640-1411-9	4.9	7.7	2.3	14.3

- 1 : All illustrations show the SMT unit (①) and Guide unit (②) assembled.
- 2 : Dimensions for card insertion are in accordance with "PC card standard".
- ③ : Indicated dimensions are symmetrical to the center of the card insertion slot.

# Reverse

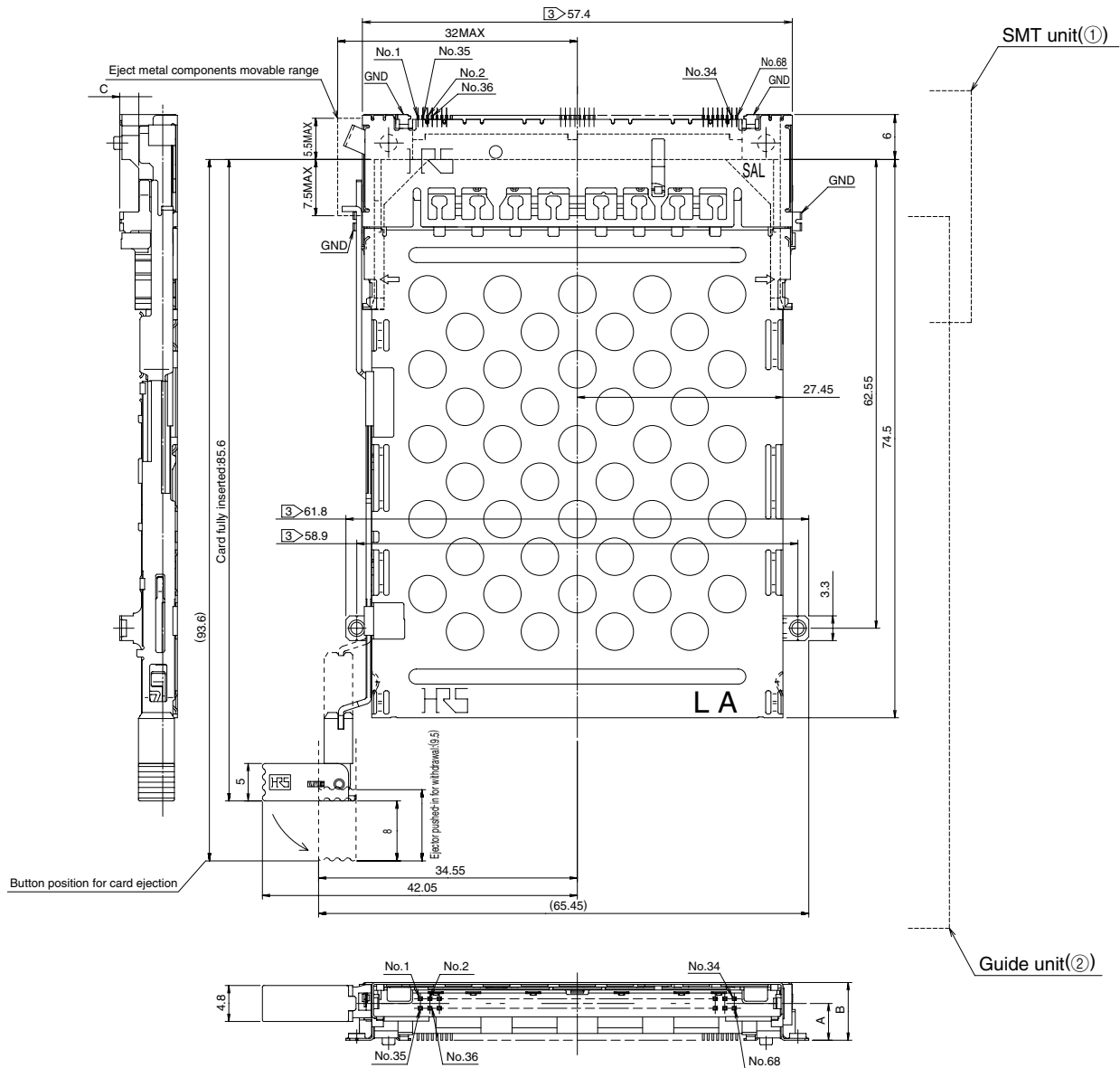
## Left Pop-up button type



Stand off height	SMT unit ①		Guide unit ②		A (mm)	B (mm)	C (mm)	Weight (g)
	Part Number	CL No.	Part Number	CL No.				
2.2mm	IC14A-PLR-SF-EJL	CL640-1308-0	IC14A-G-PEJL	CL640-1412-1	4.9	7.7	2.3	14.3

- 1 : All illustrations show the SMT unit (①) and Guide unit (②) assembled.
- 2 : Dimensions for card insertion are in accordance with "PC card standard".
- ③ : Indicated dimensions are symmetrical to the center of the card insertion slot.

**Standard**  
Left folding button



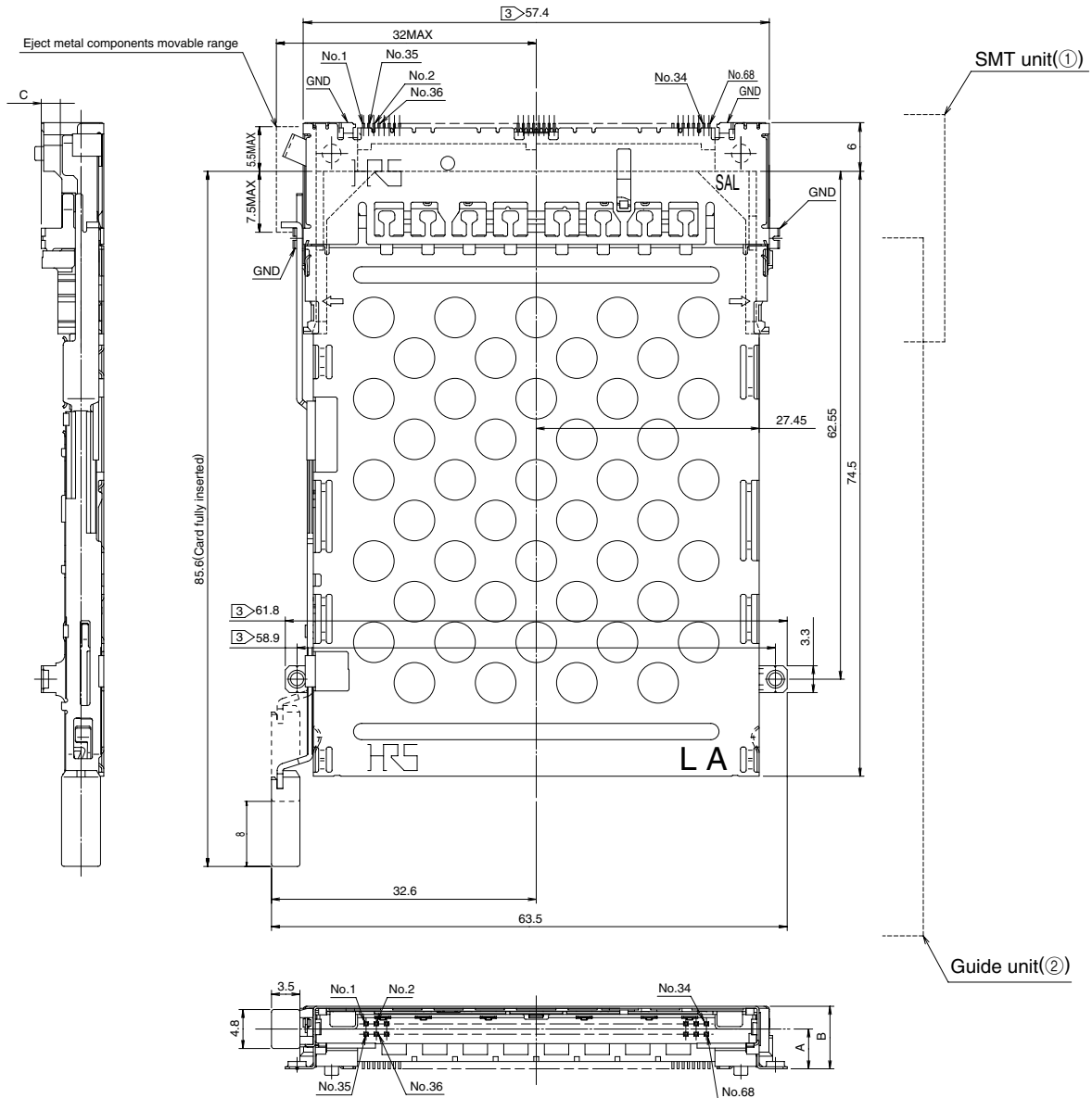
Stand off height	SMT unit ①		Guide unit ②		A (mm)	B (mm)	C (mm)	Weight (g)
	Part Number	CL No.	Part Number	CL No.				
2.2mm	IC14-PL-SF-EJL	CL640-1302-3	IC14-G-FEJL	CL640-1406-9	2.7	5.5	0.3	13.9
	IC14A-PL-SF-EJL	CL640-1304-9	IC14A-G-FEJL	CL640-1408-4	4.9	7.7	2.5	14.1

- 1 : All illustrations show the SMT unit (①) and Guide unit (②) assembled.
- 2 : Dimensions for card insertion are in accordance with "PC card standard".
- ③ : Indicated dimensions are symmetrical to the center of the card insertion slot.





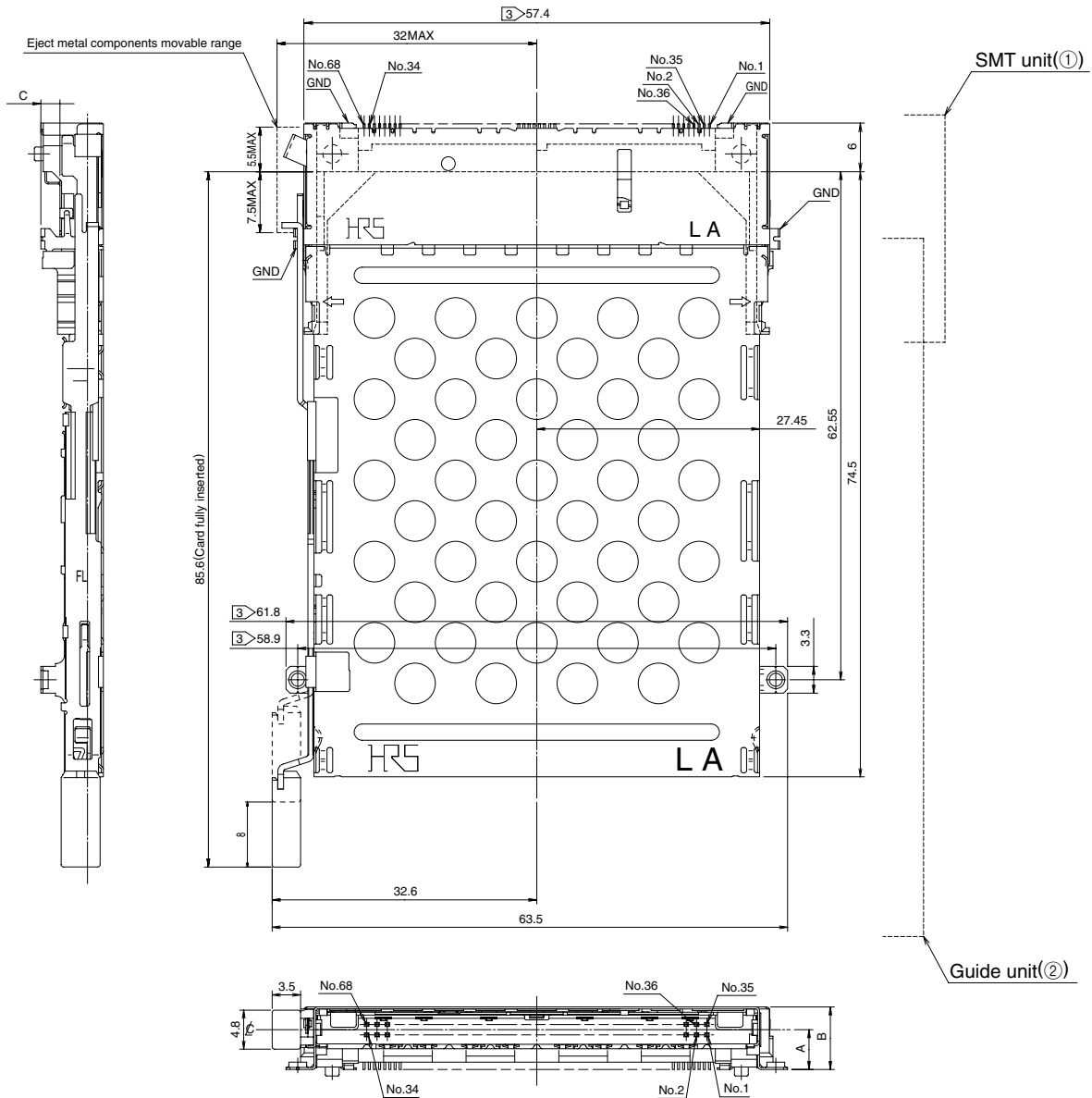
**Standard**  
Left rigid button



Stand off height	SMT unit ①		Guide unit ②		A (mm)	B (mm)	C (mm)	Weight (g)
	Part Number	CL No.	Part Number	CL No.				
2.2mm	IC14-PL-SF-EJL	CL640-1302-3	IC14-G-EJL	CL640-1402-8	2.7	5.5	0.3	13.4
	IC14A-PL-SF-EJL	CL640-1304-9	IC14A-G-EJL	CL640-1404-3	4.9	7.7	2.5	13.7

- 1 : All illustrations show the SMT unit (①) and Guide unit (②) assembled.  
 2 : Dimensions for card insertion are in accordance with "PC card standard".  
 ③ : Indicated dimensions are symmetrical to the center of the card insertion slot.

**Reverse**  
**Left rigid button**



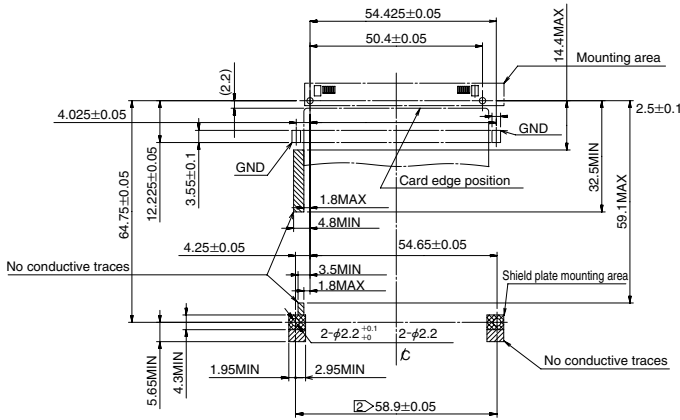
Stand off height	SMT unit ①		Guide unit ②		A (mm)	B (mm)	C (mm)	Weight (g)
	Part Number	CL No.	Part Number	CL No.				
2.2mm	IC14A-PLR-SF-EJL	CL640-1308-0	IC14A-G-EJL	CL640-1404-3	4.9	7.7	2.3	14.4

- 1 : All illustrations show the SMT unit (①) and Guide unit (②) assembled.  
 2 : Dimensions for card insertion are in accordance with "PC card standard".  
 ③ : Indicated dimensions are symmetrical to the center of the card insertion slot.

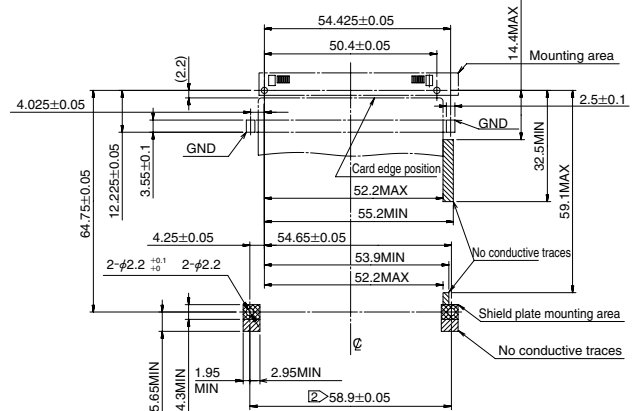
# ◆PCB mounting pattern

## ●Standard

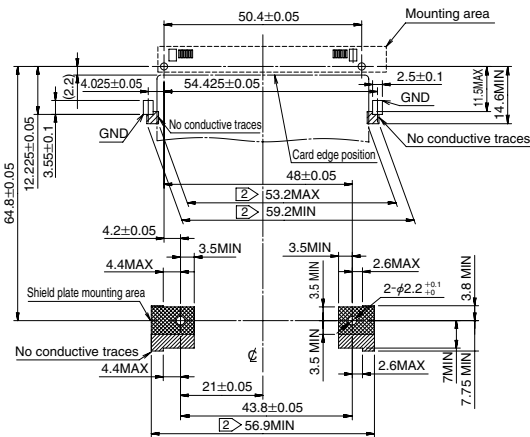
### ●Without Standoff (Left button)



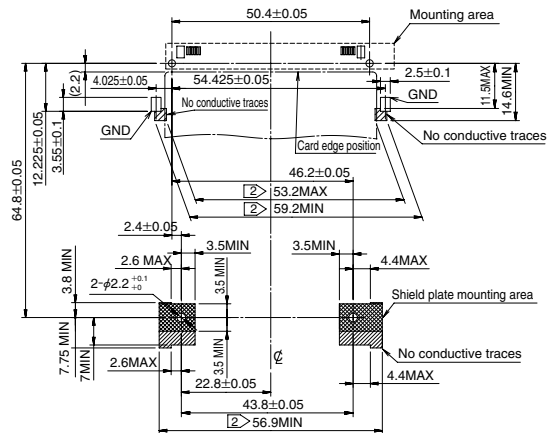
### ●Without Standoff (Right button)



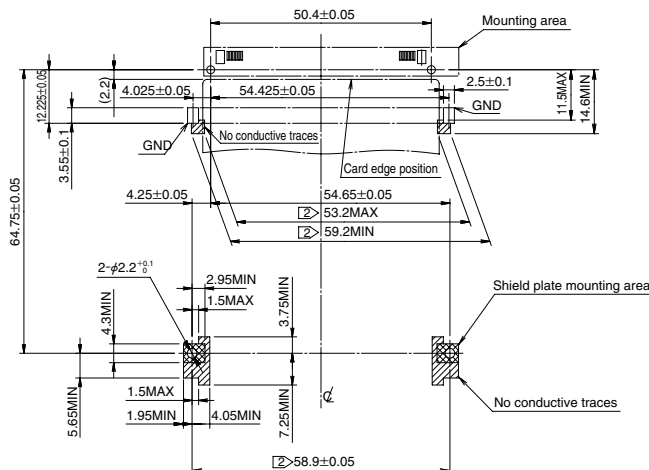
### ●Standoff 1.5mm (Left button)




### ●Standoff 1.5mm (Right button)



### ●Standoff 2.2mm (Common to both Right & left buttons)

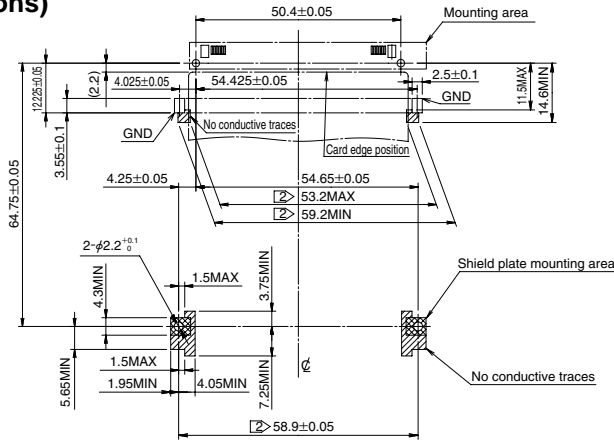


Note 1)  area show the conductive pattern prohibited area.

 ) Indicated dimensions are symmetrical to the center of the card insertion slot.

●Reverse

- Standoff 2.2mm  
(Common to both Right & left buttons)



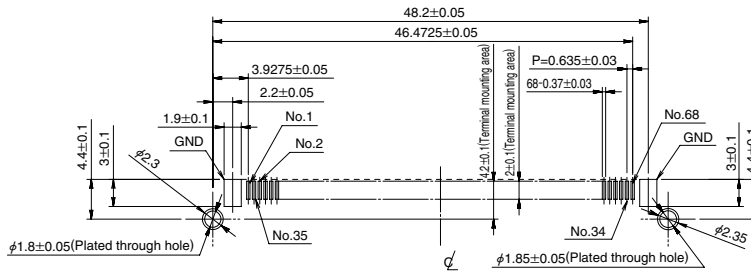
Note 1) area show the conductive pattern prohibited area.

) Indicated dimensions are symmetrical to the center of the card insertion slot.

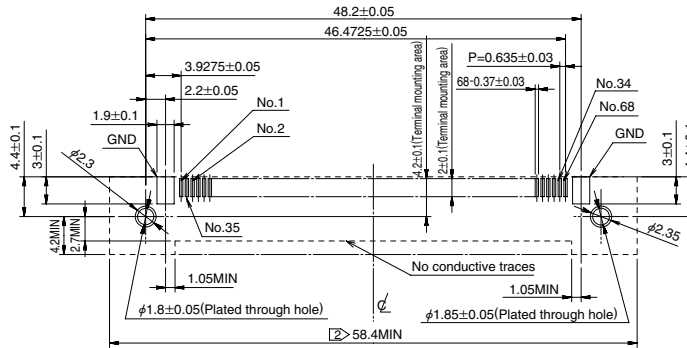
◆PCB mounting area (Enlarged views)

●Standard

- Without Standoff

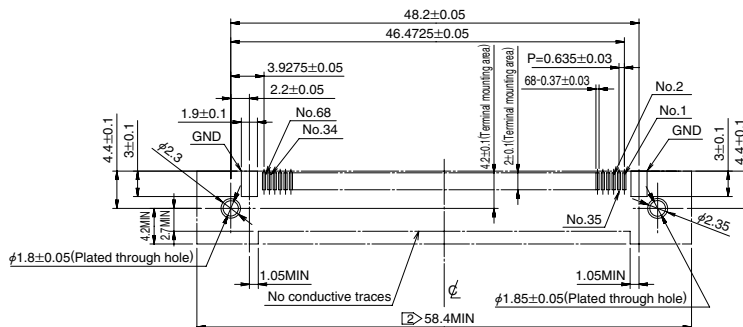


- Standoff 1.5mm, 2.2mm



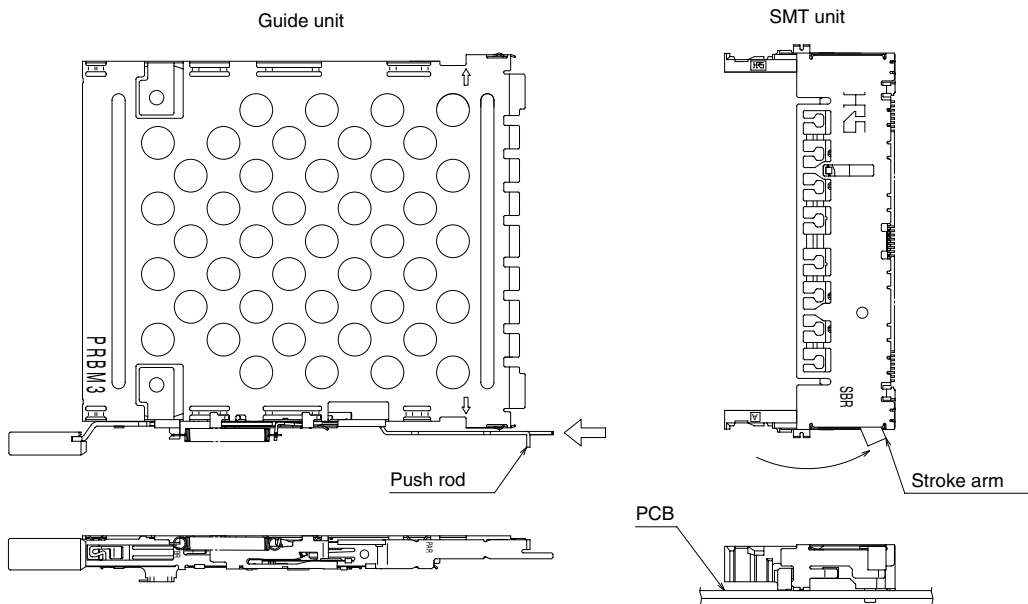
●Reverse

- Standoff 2.2mm



## ◆ Assembly of units and board placement procedures

(1) Mount the SMT unit on the PCB board.



**Fig. 1**

Note 1: Verify and make sure that the position of the stroke arm of the SMT unit and the push rod of the Guide unit are at the positions indicated in Fig. 1. (as delivered).

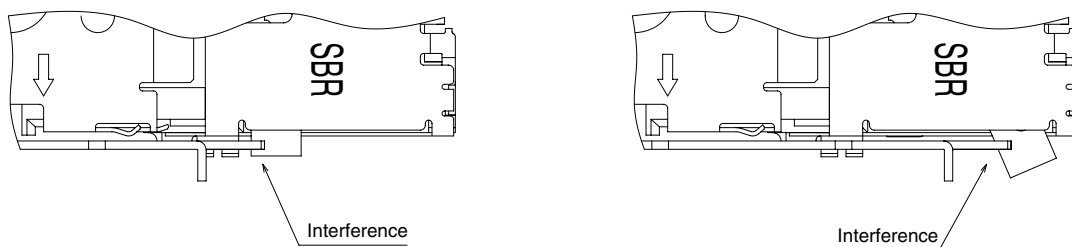
If needed, position them as shown.

Correct position of the push rod and the stroke arm is required for correct assembly of both units.

Note 2: Make sure that the SMT unit is positioned securely.

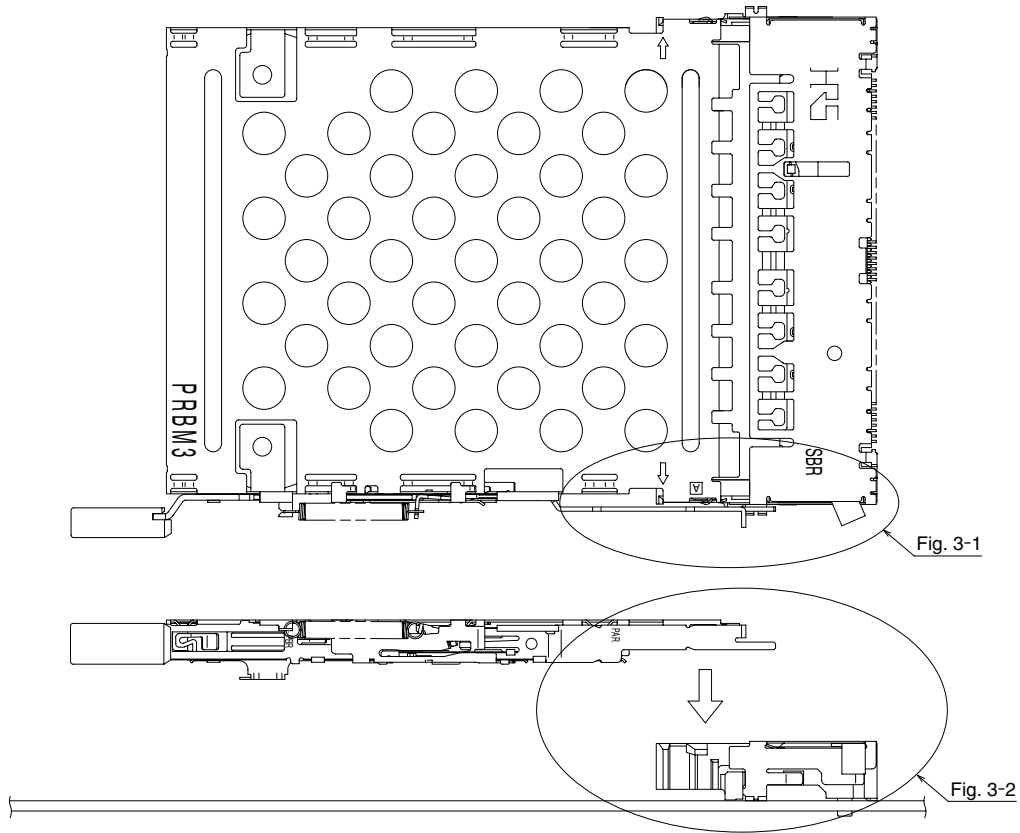
Note 3: Soldering will not be possible with the Guide unit attached first.

The Guide unit must be attached and secured to the PCB board AFTER the SMT unit is attached to the PCB.

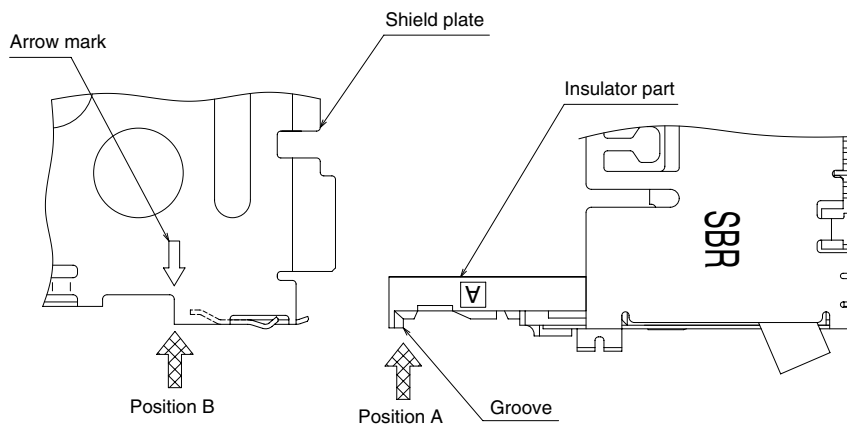


**Fig. 2**

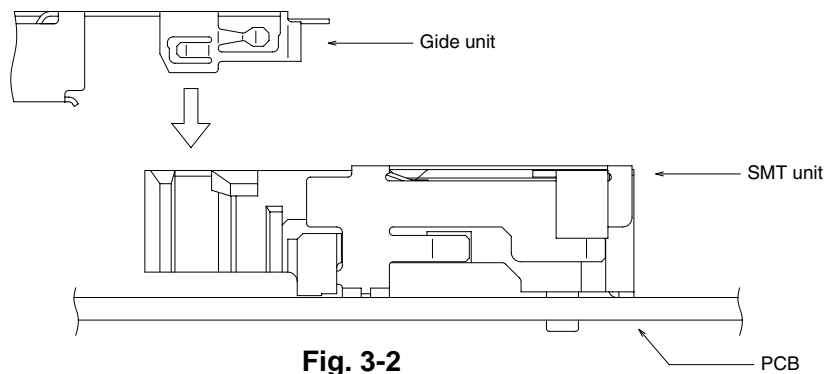
(2) Align both arrow marks (stamped on the shield plate) on the Guide unit with the corresponding grooves on the (mounted on the board) SMT unit (as illustrated of Fig. 3 and 3-1).



**Fig. 3**



**Fig. 3-1**



**Fig. 3-2**

Note 3: Place the Guide unit over the installed SMT unit, (exercising caution NOT to touch the spring, push rod or the stroke arm).Ref. Fig.4

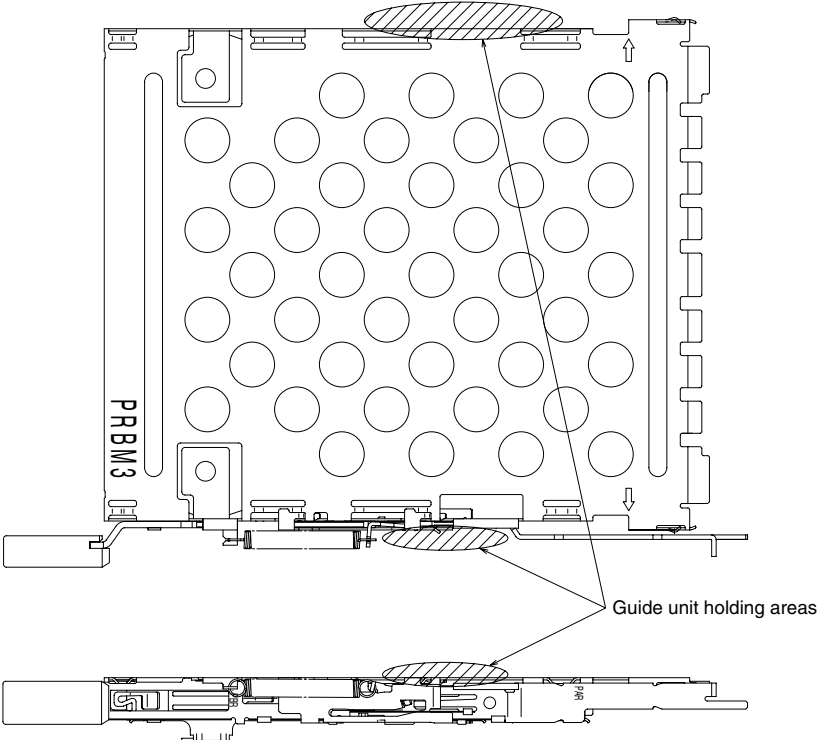
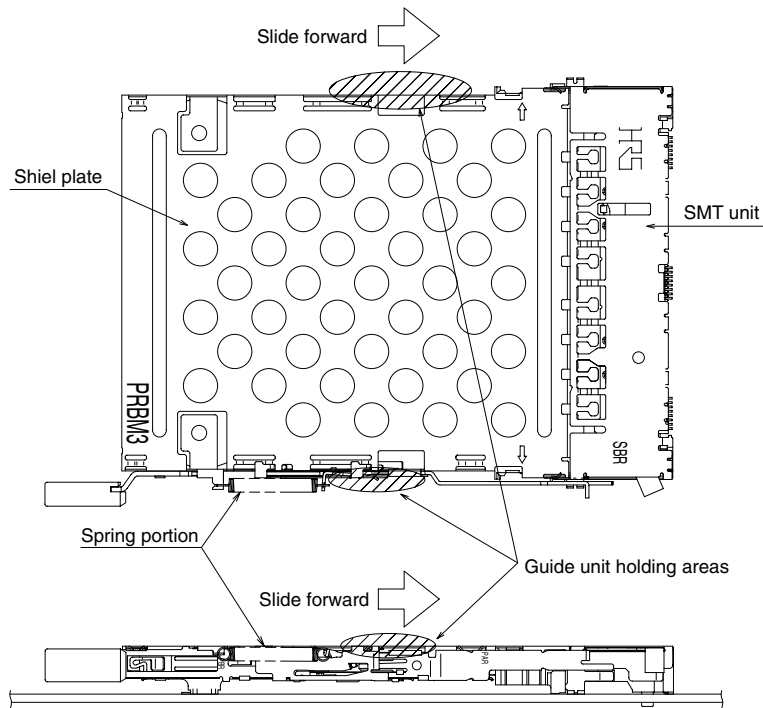


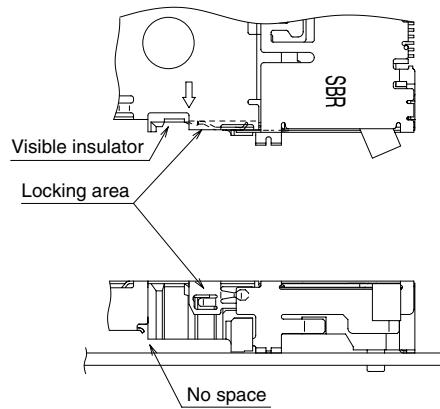
Fig. 4



- (3) Slide the Guide unit forward until it is locked with the SMT unit.  
Fully locked units should be as shown on Fig. 5.



**Fully locked**

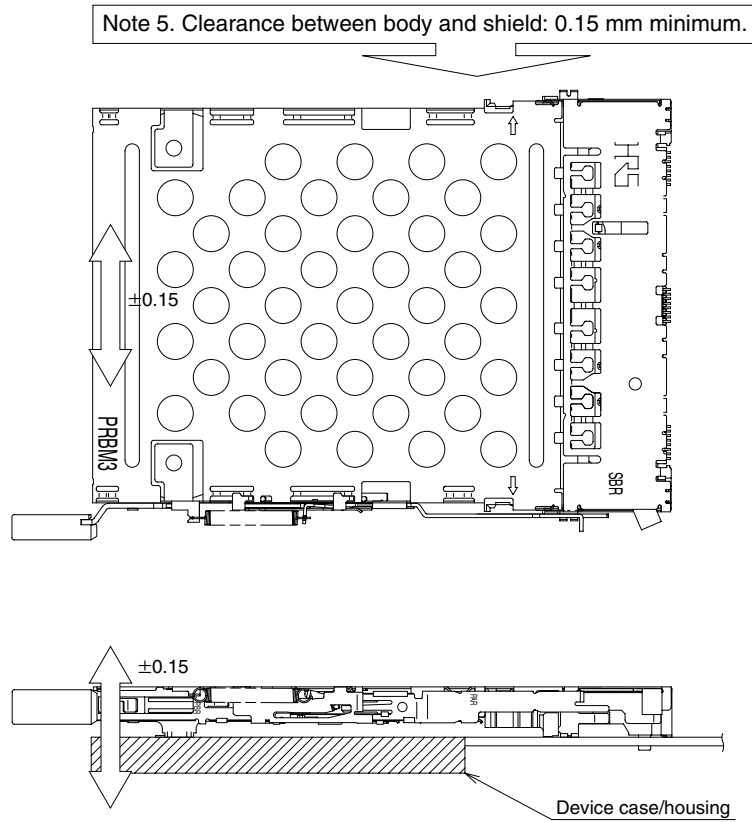


**Fig. 5**

Note 5: It is assumed that the Guide unit and the SMT unit will be mounted on the same PCB. However, in some applications the Guide unit may be mounted directly on the device's case/housing.

It is critical that the miss-alignment of the Guide unit must be kept within  $\pm 0.15$  mm.

The side clearance between the case/housing and the shield plate should be 0.15mm minimum. Ref. Fig. 6

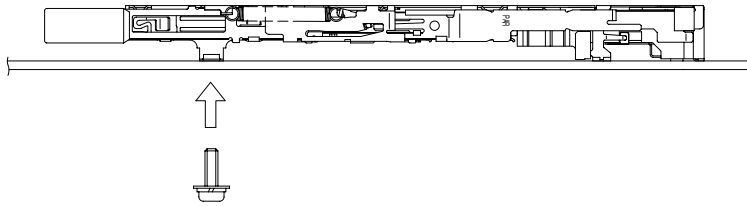


**Fig. 6**

Note 6: DO NOT insert/eject the PC card before the SMT unit and the Guide unit are fully mounted and locked, with the push rod and stroke arm connected.

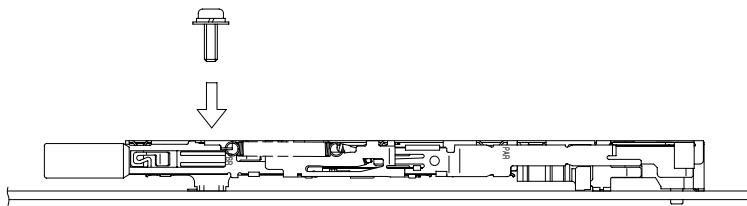
(4) The Guide unit should be securely attached with two screws.

**(4-1) IC14 and IC14A Types ... Fig. 7 (From the bottom of the PCB)**



**Fig. 7**

**(4-2) IC14B Type ... Fig. 8 (From the top of the PCB)**



**Fig. 8**

Note 7: The IC14 and IC14A assemblies do not require separate hex nuts.

Note 8: Hex nuts and screws are required for the IC14B assemblies. Max. length of the screw thread is 1.4mm.

Screw size	Connector type	Recommended tightening torque (N·m)
M2×0.4	IC14 type	0.12~0.16
	IC14A and IC14B type	0.14~0.18

## ◆ Recommended procedure for removal of the Guide unit

- (1) Remove the 2 screws attaching the Guide unit to the PCB.
- (2) Make sure that the stroke arm of the SMT unit and the pushrod of the Guide unit are at the positions indicated in Fig. 1.

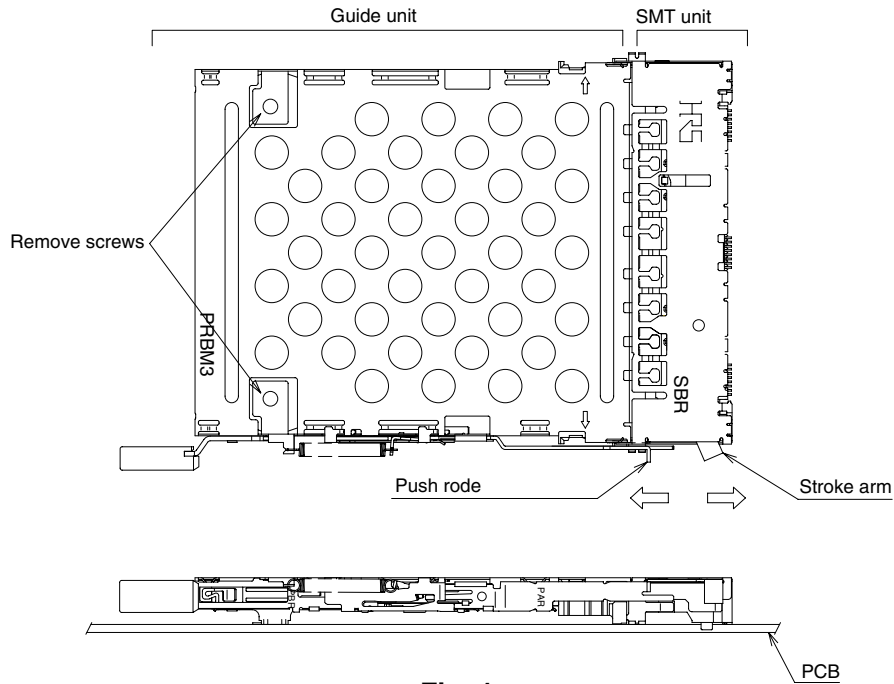


Fig. 1

- (3) As illustrated in Fig. 2, the lock between the shield plate and the ribs of the insulated case can be released. Press the insulator on both side of the installed assembly and carefully slide the Guide unit.

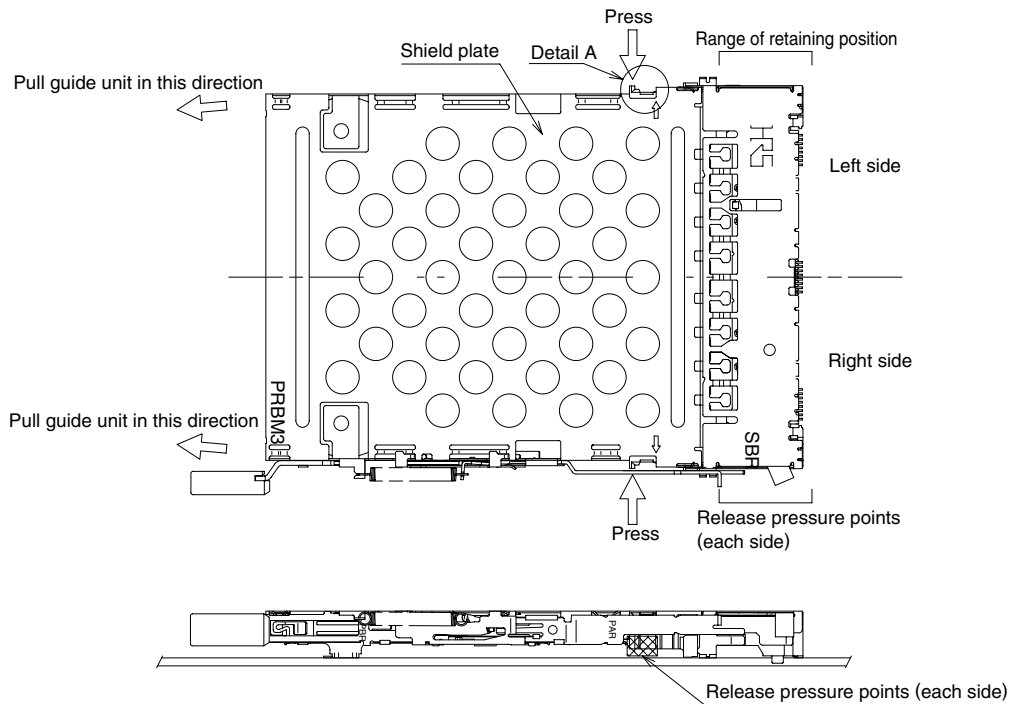
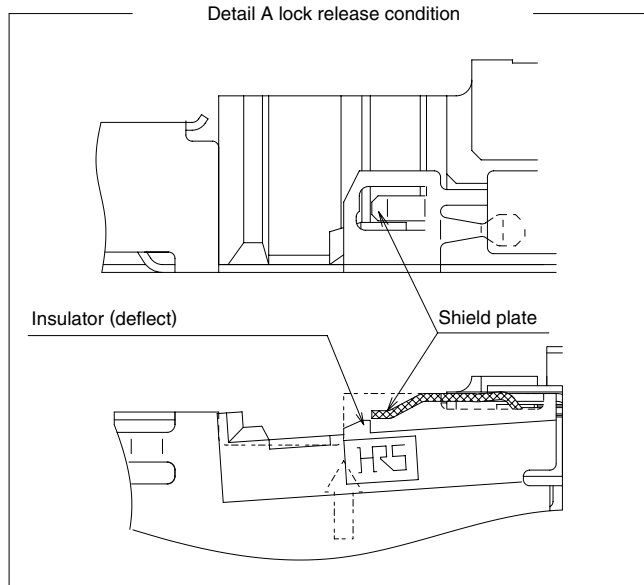


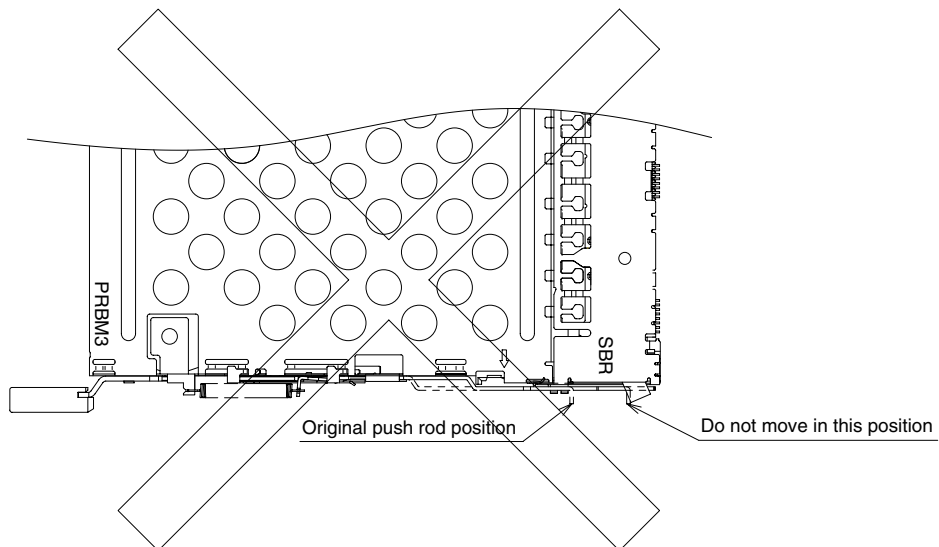
Fig. 2

Note 1: As illustrated in the enlarged view of Fig. 3, the lock is released by deflecting the insulator approximately 0.5 mm.



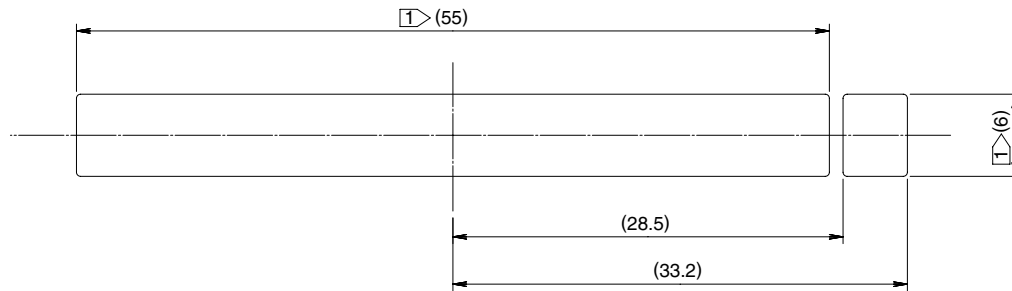
**Fig. 3 detail A - enlarged view**

Note 2: Assure that the push rod remains in its original position. Moving it from this position may cause it to fall-out.



**Fig. 4**

## ◆ Recommended opening dimensions for the device housing (Card Insertion Slot and Ejection button guide)



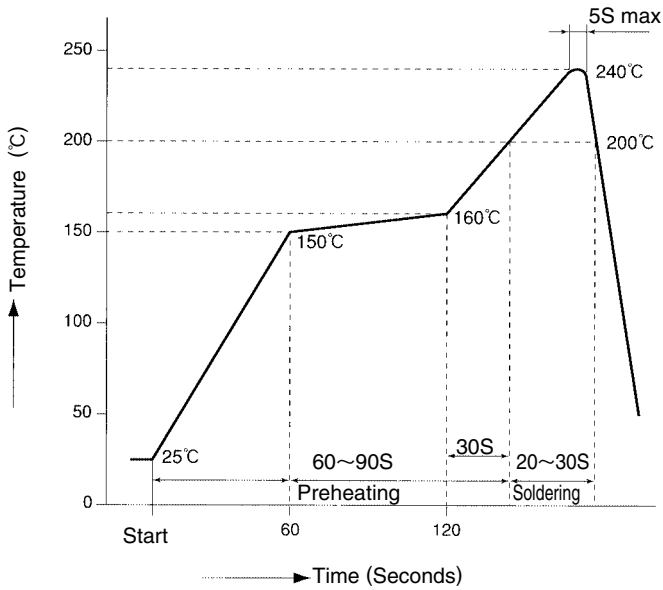
1 : PC Card center Line dimensions

## ◆ Handling Precautions

- (1) Metal components of these connector assemblies have sharp edges. Use caution when handling, installing or dis-assembling.
- (2) The design of the device's case/housing should incorporate sufficient guide and support for the ejection button.
- (3) Slight tool marks or cleaning liquid residue the surfaces of the Guide unit will not affect form, fit or function of the assemblies.

## ◆ Recommended temperature profile

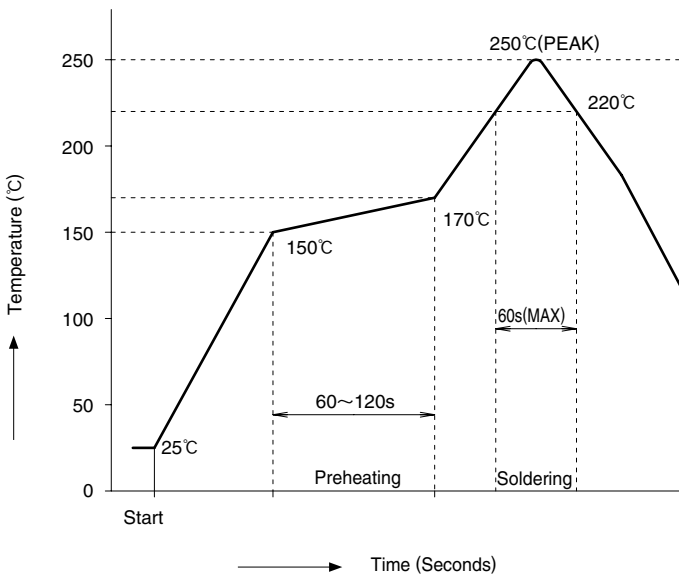
### ● Using Typical Solder Paste



#### Recommended conditions

Reflow system	: IR reflow
Solder composition	: Paste, 63%Sn/37%Pb (Flux content 9wt%)
Test board	: Glass epoxy 80mm×125mm×1.6mm thick
Metal mask	: 0.15mm thick

### ● Using Lead-free Solder Paste



#### Recommended conditions

Reflow system	: IR reflow
Solder composition	: Paste, 96.5%Sn/3.0%Ag/0.5%Cu (Flux content 10.5wt%)
Test board	: Glass epoxy 80mm×125mm×1.6mm thick
Metal mask	: 0.15mm thick

The temperature profiles are based on the above conditions. In individual applications the actual temperature may vary, depending on solder paste type, volume/thickness and board size/thickness. Consult your solder paste and equipment manufacturer for specific recommendations.