

**Features**

- Fast Read Access Time - 45 ns
- Low Power CMOS Operation
  - 100  $\mu$ A max. Standby
  - 25 mA max. Active at 5 MHz (AT27C010L)
  - 40 mA max. Active at 5 MHz (AT27C010)
- Wide Selection of JEDEC Standard Packages
  - 32-Lead 600-mil PDIP and Cerdip
  - 32-Pad PLCC and LCC
  - 32-Lead TSOP
- 5 V  $\pm$  10% Supply
- High Reliability CMOS Technology
  - 2000 V ESD Protection
  - 200 mA Latchup Immunity
- Rapid Programming - 100  $\mu$ s/byte (typical)
- Two-line Control
- CMOS and TTL Compatible Inputs and Outputs
- Integrated Product Identification Code
- Full Military, Commercial and Industrial Temperature Ranges

**1 Megabit  
(128K x 8)  
UV  
Erasable  
CMOS  
EPROM**

**Description**

The AT27C010/L chip family is a low-power, high performance 1,048,576 bit Ultraviolet Erasable and Electrically Programmable Read Only Memory (EPROM) organized as 128K x 8 bits. They require only one 5 V power supply in normal read mode operation. Any byte can be accessed in less than 45 ns, eliminating the need for speed reducing WAIT states on high performance microprocessor systems.

Two power versions are offered. In read mode, the AT27C010 typically consumes 25 mA while the AT27C010L takes only 8 mA. Standby mode supply current for both parts is typically less than 10  $\mu$ A. (continued)

**Pin Configurations**

Pin Name	Function
A0-A16	Addresses
O0-O7	Outputs
CE	Chip Enable
OE	Output Enable
PGM	Program Strobe
NC	No Connect

CDIP, PDIP Top View

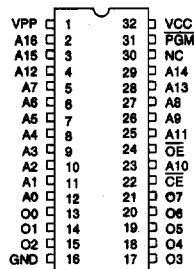

LCC, JLCC, PLCC Top

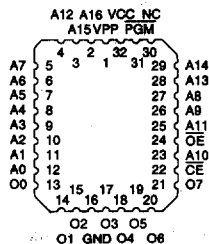

TSOP Top View  
Type 1

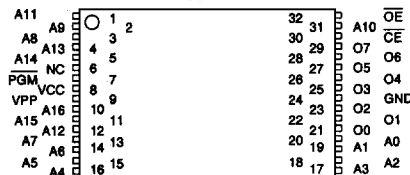



## Description (Continued)

The AT27C010/L comes in a choice of industry standard JEDEC-approved packages including: one-time programmable (OTP) plastic PDIP, PLCC, and TSOP, as well as windowed ceramic CerDip and LCC. All devices feature two line control ( $\overline{CE}$ ,  $\overline{OE}$ ) to give designers the flexibility to prevent bus contention.

With high density 128K byte storage capability, the AT27C010/L allow firmware to be stored reliably and to be accessed by the system without the delays of mass storage media.

Atmel's 27C010/L have additional features to ensure high quality and efficient production use. The Rapid Programming Algorithm reduces the time required to program the part and guarantees reliable programming. Programming time is typically only 100  $\mu$ s/byte. The Integrated Product Identification Code electronically identifies the device and manufacturer. This feature is used by industry standard programming equipment to select the proper programming algorithms and voltages.

## Erase Characteristics

The entire memory array of the AT27C010/L is erased (all outputs read as  $V_{OH}$ ) after exposure to ultraviolet light at a wavelength of 2537 $\text{\AA}$ . Complete erasure is assured after a minimum of 20 minutes exposure using 12,000  $\mu$ W/cm<sup>2</sup> intensity lamps spaced one inch away from the chip. Minimum erase time for lamps at other intensity ratings can be calculated from the minimum integrated erasure dose of 15 W $\cdot$ sec/cm<sup>2</sup>. To prevent unintentional erasure, an opaque label is recommended to cover the clear window on any UV erasable EPROM which will be subjected to continuous fluorescent indoor lighting or sunlight.

## Block Diagram

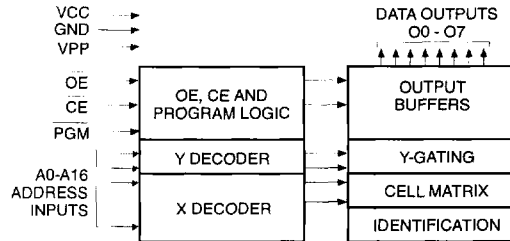

## Absolute Maximum Ratings\*

Temperature Under Bias .....	-55°C to +125°C
Storage Temperature.....	-65°C to +150°C
Voltage on Any Pin with Respect to Ground.....	-2.0 V to +7.0 V <sup>(1)</sup>
Voltage on A9 with Respect to Ground .....	-2.0 V to +14.0 V <sup>(1)</sup>
V <sub>PP</sub> Supply Voltage with Respect to Ground.....	-2.0 V to +14.0 V <sup>(1)</sup>
Integrated UV Erase Dose.....	7258 W $\cdot$ sec/cm <sup>2</sup>

\*NOTICE: Stresses beyond those listed under "Absolute Maximum Ratings" may cause permanent damage to the device.

This is a stress rating only and functional operation of the device at these or any other conditions beyond those indicated in the operational sections of this specification is not implied.

Exposure to absolute maximum rating conditions for extended periods may affect device reliability.

Notes:

1. Minimum voltage is -0.6 V dc which may undershoot to -2.0 V for pulses of less than 20 ns. Maximum output pin voltage is  $V_{CC} + 0.75$  V dc which may overshoot to +7.0 V for pulses of less than 20 ns.

## Operating Modes

Mode \ Pin	$\overline{CE}$	$\overline{OE}$	PGM	A <sub>i</sub>	V <sub>PP</sub>	V <sub>CC</sub>	Outputs
Read	V <sub>IL</sub>	V <sub>IL</sub>	X <sup>(1)</sup>	A <sub>i</sub>	X	V <sub>CC</sub>	D <sub>OUT</sub>
Output Disable	X	V <sub>IH</sub>	X	X	X	V <sub>CC</sub>	High Z
Standby	V <sub>IH</sub>	X	X	X	X	V <sub>CC</sub>	High Z
Rapid Program <sup>(2)</sup>	V <sub>IL</sub>	V <sub>IH</sub>	V <sub>IL</sub>	A <sub>i</sub>	V <sub>PP</sub>	V <sub>CC</sub>	D <sub>IN</sub>
PGM Verify	V <sub>IL</sub>	V <sub>IL</sub>	V <sub>IH</sub>	A <sub>i</sub>	V <sub>PP</sub>	V <sub>CC</sub>	D <sub>OUT</sub>
PGM Inhibit	V <sub>IH</sub>	X	X	X	V <sub>PP</sub>	V <sub>CC</sub>	High Z
Product Identification <sup>(4)</sup>	V <sub>IL</sub>	V <sub>IL</sub>	X	A <sub>9</sub> =V <sub>IH</sub> <sup>(3)</sup> A <sub>0</sub> =V <sub>IH</sub> or V <sub>IL</sub> A <sub>1</sub> -A <sub>16</sub> =V <sub>IL</sub>	X	V <sub>CC</sub>	Identification Code

- Notes:
1. X can be V<sub>IL</sub> or V<sub>IH</sub>.
  2. Refer to Programming characteristics.
  3. V<sub>H</sub> = 12.0  $\pm$  0.5 V.

4. Two identifier bytes may be selected. All A<sub>i</sub> inputs are held low (V<sub>IL</sub>), except A<sub>9</sub> which is set to V<sub>IH</sub> and A<sub>0</sub> which is toggled low (V<sub>IL</sub>) to select the Manufacturer's Identification byte and high (V<sub>IH</sub>) to select the Device Code byte.

## D.C. and A.C. Operating Conditions for Read Operation

AT27C010 / AT27C010L								
		-45	-55	-70	-90	-12	-15	-20
Operating Temp. (Case)	Com.	0°C - 70°C	0°C - 70°C	0°C - 70°C	0°C - 70°C	0°C - 70°C	0°C - 70°C	0°C - 70°C
	Ind.	-40°C - 85°C	-40°C - 85°C	-40°C - 85°C	-40°C - 85°C	-40°C - 85°C	-40°C - 85°C	-40°C - 85°C
	Mil.			-55°C - 125°C	-55°C - 125°C	-55°C - 125°C	-55°C - 125°C	-55°C - 125°C
V <sub>CC</sub> Supply		5 V ± 10%	5 V ± 10%	5 V ± 10%	5 V ± 10%	5 V ± 10%	5 V ± 10%	5 V ± 10%

3

▨ = Advance Information

## D.C. and Operating Characteristics for Read Operation

Symbol	Parameter	Condition	Min	Max	Units	
I <sub>LI</sub>	Input Load Current	V <sub>IN</sub> = 0 V to V <sub>CC</sub>	Com., Ind.	±1	μA	
			Mil.	±5	μA	
I <sub>LO</sub>	Output Leakage Current	V <sub>OUT</sub> = 0 V to V <sub>CC</sub>	Com., Ind.	±5	μA	
			Mil.	±10	μA	
I <sub>PP1</sub> <sup>(2)</sup>	V <sub>PP</sub> <sup>(1)</sup> Read/Standby Current	V <sub>PP</sub> = V <sub>CC</sub>		10	μA	
I <sub>SB</sub>	V <sub>CC</sub> <sup>(1)</sup> Standby Current	I <sub>SB1</sub> (CMOS), $\overline{CE} = V_{CC} \pm 0.3$ V		100	μA	
		I <sub>SB2</sub> (TTL), $\overline{CE} = 2.0$ to V <sub>CC</sub> +0.5 V		1	mA	
I <sub>CC</sub>	V <sub>CC</sub> Active Current	f = 5 MHz, I <sub>OUT</sub> = 0 mA, CE = V <sub>IL</sub>	AT27C010L	Com.	25	mA
				Ind., Mil.	30	mA
			AT27C010	Com.	40	mA
				Ind., Mil.	50	mA
V <sub>IL</sub>	Input Low Voltage		-0.6	0.8	V	
V <sub>IH</sub>	Input High Voltage		2.0	V <sub>CC</sub> +0.5	V	
V <sub>OL</sub>	Output Low Voltage	I <sub>OL</sub> = 2.1 mA		.45	V	
V <sub>OH</sub>	Output High Voltage	I <sub>OH</sub> = -100 μA		V <sub>CC</sub> -0.3	V	
		I <sub>OH</sub> = -2.5 mA		3.5	V	
		I <sub>OH</sub> = -400 μA		2.4	V	

Notes: 1. V<sub>CC</sub> must be applied simultaneously or before V<sub>PP</sub>, and removed simultaneously or after V<sub>PP</sub>.  
 2. V<sub>PP</sub> may be connected directly to V<sub>CC</sub>, except during programming. The supply current would then be the sum of I<sub>CC</sub> and I<sub>PP</sub>.

## A.C. Characteristics for Read Operation

			AT27C010 / AT27C010L														
			-45		-55		-70		-90		-12		-15		-20		Units
Symbol	Parameter	Condition	Min	Max	Min	Max	Min	Max	Min	Max	Min	Max	Min	Max	Min	Max	
t <sub>ACC</sub> <sup>(3)</sup>	Address to Output Delay	$\overline{CE} = \overline{OE}$ = V <sub>IL</sub>	Com., Ind.	45	55	70	90	120	150	200							ns
			Mil.			70	90	120	150	200							ns
t <sub>CE</sub> <sup>(2)</sup>	$\overline{CE}$ to Output Delay	$\overline{OE} = V_{IL}$	45	55	70	90	120	150	200								ns
t <sub>OE</sub> <sup>(2,3)</sup>	$\overline{OE}$ to Output Delay	$\overline{CE} = V_{IL}$	20	25	30	35	35	40	70								ns
t <sub>DF</sub> <sup>(4,5)</sup>	$\overline{OE}$ or $\overline{CE}$ High to Output Float		20	20	25	25	30	35	40								ns
t <sub>OH</sub>	Output Hold from Address, $\overline{CE}$ or $\overline{OE}$ , whichever occurred first		7	7	7	0	0	0	0								ns

Notes: 2, 3, 4, 5. - see AC Waveforms for Read Operation.

▨ = Advance Information



## A.C. Waveforms for Read Operation <sup>(1)</sup>

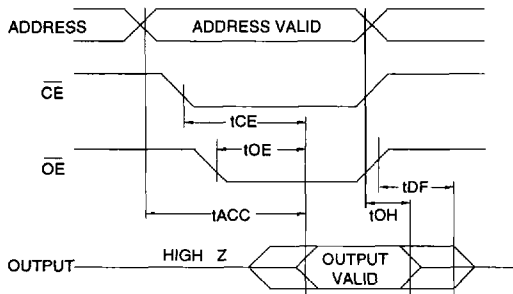

Notes:

1. Timing measurement references are 0.8 V and 2.0 V. Input AC driving levels are 0.45 V and 2.4 V, unless otherwise specified. Timing measurement reference is 1.5 V for -45 and -55 parts. Input AC driving levels are 0.0 V and 3.0 V for -45 and -55 parts, unless otherwise specified.
2.  $\overline{OE}$  may be delayed up to  $t_{CE-tOE}$  after the falling edge of  $\overline{CE}$  without impact on  $t_{CE}$ .
3.  $\overline{OE}$  may be delayed up to  $t_{ACC-tOE}$  after the address is valid without impact on  $t_{ACC}$ .
4. This parameter is only sampled and is not 100% tested.
5. Output float is defined as the point when data is no longer driven.

## Input Test Waveforms and Measurement Levels

For -45 and -55 devices only:

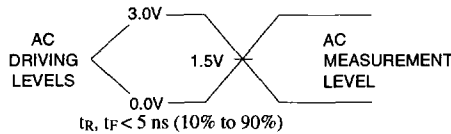

For -70, -90, -12, -15, and -20 devices:

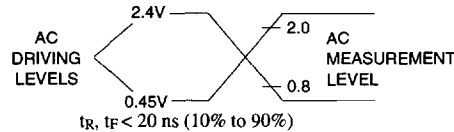

## Output Test Load

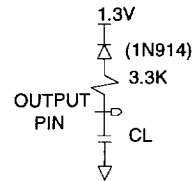

Note:  $C_L = 100$  pF including jig capacitance, except for the -45 and -55 devices, where  $C_L = 30$  pF.

## Pin Capacitance ( $f = 1$ MHz, $T = 25^\circ\text{C}$ ) <sup>(1)</sup>

	Typ	Max	Units	Conditions
$C_{IN}$	4	8	pF	$V_{IN} = 0$ V
$C_{OUT}$	8	12	pF	$V_{OUT} = 0$ V

Notes: 1. Typical values for nominal supply voltage. This parameter is only sampled and is not 100% tested.

## Programming Waveforms <sup>(1)</sup>

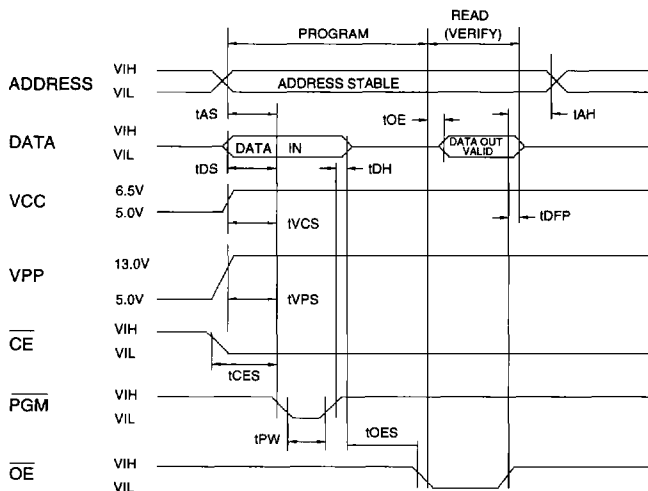

Notes:

1. The Input Timing Reference is 0.8 V for  $V_{IL}$  and 2.0 V for  $V_{IH}$ .
2.  $t_{OE}$  and  $t_{DFP}$  are characteristics of the device but must be accommodated by the programmer.
3. When programming the AT27C010/L a 0.1- $\mu\text{F}$  capacitor is required across  $V_{PP}$  and ground to suppress spurious voltage transients.

**D.C. Programming Characteristics**

T<sub>A</sub> = 25 ± 5°C, V<sub>CC</sub> = 6.5 ± 0.25 V, V<sub>PP</sub> = 13.0 ± 0.25 V

Sym- bol	Parameter	Test Conditions	Limits		
			Min	Max	Units
I <sub>LI</sub>	Input Load Current	V <sub>IN</sub> =V <sub>IL</sub> ,V <sub>IH</sub>	10		μA
V <sub>IL</sub>	Input Low Level	(All Inputs)	-0.6	0.8	V
V <sub>IH</sub>	Input High Level		2.0	V <sub>CC</sub> +1	V
V <sub>OL</sub>	Output Low Volt.	I <sub>OL</sub> =2.1 mA	.45		V
V <sub>OH</sub>	Output High Volt.	I <sub>OH</sub> =-400 μA	2.4		V
I <sub>CC2</sub>	V <sub>CC</sub> Supply Current (Program and Verify)		40		mA
I <sub>PP2</sub>	V <sub>PP</sub> Supply Current	$\overline{CE}=\overline{PGM}=V_{IL}$	20		mA
V <sub>ID</sub>	A9 Product Identification Voltage		11.5	12.5	V

**A.C. Programming Characteristics**

T<sub>A</sub> = 25 ± 5°C, V<sub>CC</sub> = 6.5 ± 0.25 V, V<sub>PP</sub> = 13.0 ± 0.25 V

Sym- bol	Parameter	Test Conditions* (see Note 1)	Limits		
			Min	Max	Units
t <sub>AS</sub>	Address Setup Time		2		μs
t <sub>CES</sub>	$\overline{CE}$ Setup Time		2		μs
t <sub>OES</sub>	$\overline{OE}$ Setup Time		2		μs
t <sub>DS</sub>	Data Setup Time		2		μs
t <sub>AH</sub>	Address Hold Time		0		μs
t <sub>DH</sub>	Data Hold Time		2		μs
t <sub>DFP</sub>	$\overline{OE}$ High to Out- put Float Delay	(Note 2)	0	130	ns
t <sub>VPS</sub>	V <sub>PP</sub> Setup Time		2		μs
t <sub>VCS</sub>	V <sub>CC</sub> Setup Time		2		μs
t <sub>PW</sub>	PGM Program Pulse Width	(Note 3)	95	105	μs
t <sub>OE</sub>	Data Valid from $\overline{OE}$			150	ns

\*A.C. Conditions of Test:

- Input Rise and Fall Times (10% to 90%) . . . . . 20 ns
- Input Pulse Levels . . . . . 0.45 V to 2.4 V
- Input Timing Reference Level . . . . . 0.8 V to 2.0 V
- Output Timing Reference Level . . . . . 0.8 V to 2.0 V

Notes:

1. V<sub>CC</sub> must be applied simultaneously or before V<sub>PP</sub> and removed simultaneously or after V<sub>PP</sub>.
2. This parameter is only sampled and is not 100% tested. Output Float is defined as the point where data is no longer driven — see timing diagram.
3. Program Pulse width tolerance is 100 μsec ± 5%.

**Atmel's 27C010/L Integrated Product Identification Code**

Codes	Pins									Hex Data
	A0	O7	O6	O5	O4	O3	O2	O1	O0	
Manufacturer	0	0	0	0	1	1	1	1	0	1E
Device Type	1	0	0	0	0	0	1	0	1	05

3

**Rapid Programming Algorithm**

A 100 μs  $\overline{PGM}$  pulse width is used to program. The address is set to the first location. V<sub>CC</sub> is raised to 6.5 V and V<sub>PP</sub> is raised to 13.0 V. Each address is first programmed with one 100 μs PGM pulse without verification. Then a verification / reprogramming loop is executed for each address. In the event a byte fails to pass verification, up to 10 successive 100 μs pulses are applied with a verification after each pulse. If the byte fails to pass after 10 pulses have been applied, the part is considered failed. After the byte verifies properly, the next address is selected until all have been checked. V<sub>pp</sub> is then lowered to 5.0 V and V<sub>CC</sub> to 5.0 V. All bytes are read again and compared with the original data to determine if the device passes or fails.

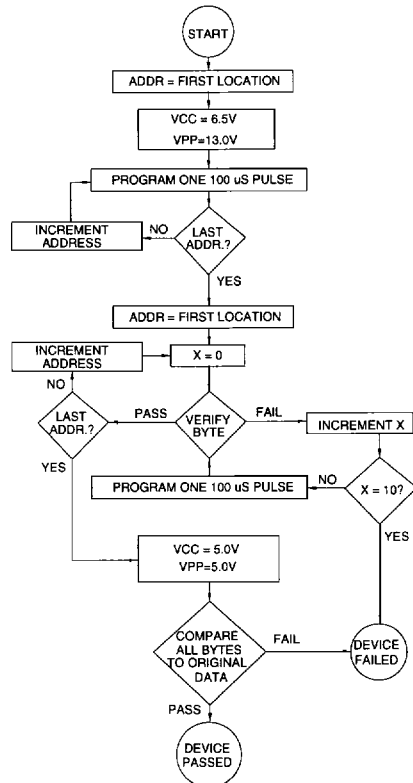



## Ordering Information

 = Advance Information

t <sub>ACC</sub> (ns)	I <sub>CC</sub> (mA)		Ordering Code	Package	Operation Range	
	Active	Standby				
45	40	0.1	AT27C010-45DC	32DW6	Commercial (0°C to 70°C)	
			AT27C010-45JC	32J		
			AT27C010-45LC	32LW		
			AT27C010-45PC	32P6		
			AT27C010-45TC	32T		
45	50	0.1	AT27C010-45DI	32DW6	Industrial (-40°C to 85°C)	
			AT27C010-45JI	32J		
			AT27C010-45LI	32LW		
			AT27C010-45PI	32P6		
			AT27C010-45TI	32T		
55	40	0.1	AT27C010-55DC	32DW6	Commercial (0°C to 70°C)	
			AT27C010-55JC	32J		
			AT27C010-55LC	32LW		
			AT27C010-55PC	32P6		
			AT27C010-55TC	32T		
55	50	0.1	AT27C010-55DI	32DW6	Industrial (-40°C to 85°C)	
			AT27C010-55JI	32J		
			AT27C010-55LI	32LW		
			AT27C010-55PI	32P6		
			AT27C010-55TI	32T		
70	40	0.1	AT27C010-70DC	32DW6	Commercial (0°C to 70°C)	
			AT27C010-70JC	32J		
			AT27C010-70LC	32LW		
			AT27C010-70PC	32P6		
			AT27C010-70TC	32T		
70	50	0.1	AT27C010-70DI	32DW6	Industrial (-40°C to 85°C)	
			AT27C010-70JI	32J		
			AT27C010-70LI	32LW		
			AT27C010-70PI	32P6		
			AT27C010-70TI	32T		
			AT27C010-70DM	32DW6		Military (-55°C to 125°C)
			AT27C010-70LM	32LW		
90	40	0.1	AT27C010-90DC	32DW6	Commercial (0°C to 70°C)	
			AT27C010-90JC	32J		
			AT27C010-90KC	32KW		
			AT27C010-90LC	32LW		
			AT27C010-90PC	32P6		
			AT27C010-90TC	32T		
90	50	0.1	AT27C010-90DI	32DW6	Industrial (-40°C to 85°C)	
			AT27C010-90JI	32J		
			AT27C010-90KI	32KW		
			AT27C010-90LI	32LW		
			AT27C010-90PI	32P6		
			AT27C010-90TI	32T		
			AT27C010-90DM	32DW6		Military (-55°C to 125°C)
			AT27C010-90KM	32KW		
			AT27C010-90LM	32LW		

**Ordering Information**

tACC (ns)	Icc (mA)		Ordering Code	Package	Operation Range
	Active	Standby			
90	50	0.1	AT27C010-90DM/883 AT27C010-90KM/883 AT27C010-90LM/883	32DW6 32KW 32LW	Military/883C Class B, Fully Compliant (-55°C to 125°C)
120	40	0.1	AT27C010-12DC AT27C010-12JC AT27C010-12KC AT27C010-12LC AT27C010-12PC AT27C010-12TC	32DW6 32J 32KW 32LW 32P6 32T	Commercial (0°C to 70°C)
120	50	0.1	AT27C010-12DI AT27C010-12JI AT27C010-12KI AT27C010-12LI AT27C010-12PI AT27C010-12TI	32DW6 32J 32KW 32LW 32P6 32T	Industrial (-40°C to 85°C)
			AT27C010-12DM AT27C010-12KM AT27C010-12LM	32DW6 32KW 32LW	Military (-55°C to 125°C)
			AT27C010-12DM/883 AT27C010-12KM/883 AT27C010-12LM/883	32DW6 32KW 32LW	Military/883C Class B, Fully Compliant (-55°C to 125°C)
150	40	0.1	AT27C010-15DC AT27C010-15JC AT27C010-15KC AT27C010-15LC AT27C010-15PC AT27C010-15TC	32DW6 32J 32KW 32LW 32P6 32T	Commercial (0°C to 70°C)
150	50	0.1	AT27C010-15DI AT27C010-15JI AT27C010-15KI AT27C010-15LI AT27C010-15PI AT27C010-15TI	32DW6 32J 32KW 32LW 32P6 32T	Industrial (-40°C to 85°C)
			AT27C010-15DM AT27C010-15KM AT27C010-15LM	32DW6 32KW 32LW	Military (-55°C to 125°C)
			AT27C010-15DM/883 AT27C010-15KM/883 AT27C010-15LM/883	32DW6 32KW 32LW	Military/883C Class B, Fully Compliant (-55°C to 125°C)
200	40	0.1	AT27C010-20DC AT27C010-20JC AT27C010-20KC AT27C010-20LC AT27C010-20PC	32DW6 32J 32KW 32LW 32P6	Commercial (0°C to 70°C)

**3**





## Ordering Information

t <sub>ACC</sub> (ns)	I <sub>CC</sub> (mA)		Ordering Code	Package	Operation Range
	Active	Standby			
200	50	0.1	AT27C010-20DI AT27C010-20JI AT27C010-20KI AT27C010-20LI AT27C010-20PI	32DW6 32J 32KW 32LW 32P6	Industrial (-40°C to 85°C)
			AT27C010-20DM AT27C010-20KM AT27C010-20LM	32DW6 32KW 32LW	Military (-55°C to 125°C)
			AT27C010-20DM/883 AT27C010-20KM/883 AT27C010-20LM/883	32DW6 32KW 32LW	Military/883C Class B, Fully Compliant (-55°C to 125°C)
90	50	0.1	5962-89614 07 M XX 5962-89614 07 M YX	32DW6 32LW	Military/883C Class B, Fully Compliant (-55°C to 125°C)
120	50	0.1	5962-89614 06 M XX 5962-89614 06 M YX	32DW6 32LW	Military/883C Class B, Fully Compliant (-55°C to 125°C)
150	50	0.1	5962-89614 05 M XX 5962-89614 05 M YX	32DW6 32LW	Military/883C Class B, Fully Compliant (-55°C to 125°C)
170	50	0.1	5962-89614 04 M XX 5962-89614 04 M YX	32DW6 32LW	Military/883C Class B, Fully Compliant (-55°C to 125°C)
200	50	0.1	5962-89614 03 M XX 5962-89614 03 M YX	32DW6 32LW	Military/883C Class B, Fully Compliant (-55°C to 125°C)
250	50	0.1	5962-89614 02 M XX 5962-89614 02 M YX	32DW6 32LW	Military/883C Class B, Fully Compliant (-55°C to 125°C)
300	50	0.1	5962-89614 01 M XX 5962-89614 01 M YX	32DW6 32LW	Military/883C Class B, Fully Compliant (-55°C to 125°C)



## Ordering Information

= Advance Information

t <sub>ACC</sub> (ns)	I <sub>CC</sub> (mA)		Ordering Code	Package	Operation Range
	Active	Standby			
45	25	0.1	AT27C010L-45DC AT27C010L-45JC AT27C010L-45LC AT27C010L-45PC AT27C010L-45TC	32DW6 32J 32LW 32P6 32T	Commercial (0°C to 70°C)
45	30	0.1	AT27C010L-45DI AT27C010L-45JI AT27C010L-45LI AT27C010L-45PI AT27C010L-45TI	32DW6 32J 32LW 32P6 32T	Industrial (-40°C to 85°C)
55	25	0.1	AT27C010L-55DC AT27C010L-55JC AT27C010L-55LC AT27C010L-55PC AT27C010L-55TC	32DW6 32J 32LW 32P6 32T	Commercial (0°C to 70°C)
55	30	0.1	AT27C010L-55DI AT27C010L-55JI AT27C010L-55LI AT27C010L-55PI AT27C010L-55TI	32DW6 32J 32LW 32P6 32T	Industrial (-40°C to 85°C)
70	25	0.1	AT27C010L-70DC AT27C010L-70JC AT27C010L-70KC AT27C010L-70LC AT27C010L-70PC AT27C010L-70TC	32DW6 32J 32KW 32LW 32P6 32T	Commercial (0°C to 70°C)
			AT27C010L-70DM AT27C010L-70LM	32DW6 32LW	Military (-55°C to 125°C)
70	30	0.1	AT27C010L-70DI AT27C010L-70JI AT27C010L-70KI AT27C010L-70LI AT27C010L-70PI AT27C010L-70TI	32DW6 32J 32KW 32LW 32P6 32T	Industrial (-40°C to 85°C)
90	25	0.1	AT27C010L-90DC AT27C010L-90JC AT27C010L-90KC AT27C010L-90LC AT27C010L-90PC AT27C010L-90TC	32DW6 32J 32KW 32LW 32P6 32T	Commercial (0°C to 70°C)

3





## Ordering Information

t <sub>ACC</sub> (ns)	I <sub>CC</sub> (mA)		Ordering Code	Package	Operation Range
	Active	Standby			
90	30	0.1	AT27C010L-90DI AT27C010L-90JI AT27C010L-90KI AT27C010L-90LI AT27C010L-90PI AT27C010L-90TI	32DW6 32J 32KW 32LW 32P6 32T	Industrial (-40°C to 85°C)
			AT27C010L-90DM AT27C010L-90KM AT27C010L-90LM	32DW6 32KW 32LW	Military (-55°C to 125°C)
			AT27C010L-90DM/883 AT27C010L-90KM/883 AT27C010L-90LM/883	32DW6 32KW 32LW	Military/883C Class B, Fully Compliant (-55°C to 125°C)
120	25	0.1	AT27C010L-12DC AT27C010L-12JC AT27C010L-12KC AT27C010L-12LC AT27C010L-12PC AT27C010L-12TC	32DW6 32J 32KW 32LW 32P6 32T	Commercial (0°C to 70°C)
120	30	0.1	AT27C010L-12DI AT27C010L-12JI AT27C010L-12KI AT27C010L-12LI AT27C010L-12PI AT27C010L-12TI	32DW6 32J 32KW 32LW 32P6 32T	Industrial (-40°C to 85°C)
			AT27C010L-12DM AT27C010L-12KM AT27C010L-12LM	32DW6 32KW 32LW	Military (-55°C to 125°C)
			AT27C010L-12DM/883 AT27C010L-12KM/883 AT27C010L-12LM/883	32DW6 32KW 32LW	Military/883C Class B, Fully Compliant (-55°C to 125°C)
150	25	0.1	AT27C010L-15DC AT27C010L-15JC AT27C010L-15LC AT27C010L-15KC AT27C010L-15PC AT27C010L-15TC	32DW6 32J 32LW 32KW 32P6 32T	Commercial (0°C to 70°C)
150	30	0.1	AT27C010L-15DI AT27C010L-15JI AT27C010L-15KI AT27C010L-15LI AT27C010L-15PI AT27C010L-15TI	32DW6 32J 32KW 32LW 32P6 32T	Industrial (-40°C to 85°C)
			AT27C010L-15DM AT27C010L-15KM AT27C010L-15LM	32DW6 32KW 32LW	Military (-55°C to 125°C)
			AT27C010L-15DM/883 AT27C010L-15KM/883 AT27C010L-15LM/883	32DW6 32KW 32LW	Military/883C Class B, Fully Compliant (-55°C to 125)

**Ordering Information**

t <sub>ACC</sub> (ns)	I <sub>CC</sub> (mA)		Ordering Code	Package	Operation Range		
	Active	Standby					
200	25	0.1	AT27C010L-20DC	32DW6 32J 32KW 32LW 32P6	Commercial (0°C to 70°C)		
			AT27C010L-20JC				
			AT27C010L-20KC				
			AT27C010L-20LC				
			AT27C010L-20PC				
200	30	0.1	AT27C010L-20DI	32DW6 32J 32KW 32LW 32P6	Industrial (-40°C to 85°C)		
			AT27C010L-20JI				
			AT27C010L-20KI				
			AT27C010L-20LI				
			AT27C010L-20PI				
			AT27C010L-20DM			32DW6 32KW 32LW	Military (-55°C to 125°C)
			AT27C010L-20KM				
			AT27C010L-20LM				
			AT27C010L-20DM/883			32DW6 32KW 32LW	Military/883C Class B, Fully Compliant (-55°C to 125°C)
AT27C010L-20KM/883							
AT27C010L-20LM/883							

**3**

Package Type	
<b>32DW6</b>	32 Lead, 0.600" Wide, Windowed, Ceramic Dual Inline Package (Cerdip)
<b>32J</b>	32 Lead, Plastic J-Leaded Chip Carrier OTP (PLCC)
<b>32KW</b>	32 Lead, Windowed, Ceramic J-Leaded Chip Carrier (JLCC)
<b>32LW</b>	32 Pad, Windowed, Ceramic Leadless Chip Carrier (LCC)
<b>32P6</b>	32 Lead, 0.600" Wide, Plastic Dual Inline Package OTP (PDIP)
<b>32T</b>	32 Lead, Plastic Thin Small Outline Package OTP (TSOP)

