

# Agilent HBAT-5400, 5402, 540B, 540C, 540E, 540F High Performance Schottky Diode for Transient Suppression

## Data Sheet

### Description

The HBAT-5400 series of Schottky diodes, commonly referred to as clipping/clamping diodes, are optimal for circuit and waveshape preservation applications with high speed switching. Low series resistance,  $R_S$ , makes them ideal for protecting sensitive circuit elements against high current transients carried on data lines. With picosecond switching, the HBAT-540x can respond to noise spikes with rise times as fast as 1 ns. Low capacitance minimizes waveshape loss that causes signal degradation.

### Package Lead Code Identification (Top View)

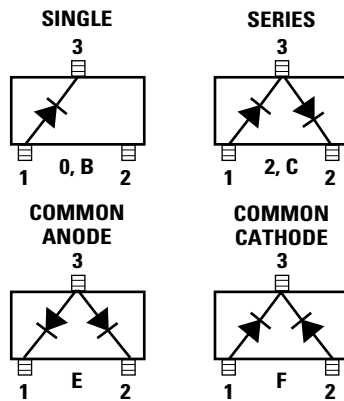

### Features

- Ultra-low Series Resistance for Higher Current Handling
- Low Capacitance
- Low Series Resistance
- Lead-free Option Available

### Applications

RF and computer designs that require circuit protection, high-speed switching, and voltage clamping.



### Absolute Maximum Ratings, $T_A = 25^\circ\text{C}$

Symbol	Parameter	Unit	Absolute Maximum <sup>[1]</sup>	
			HBAT-5400/-5402	HBAT-540B/-540C
$I_F$	DC Forward Current	mA	220	430
$I_{F\text{-peak}}$	Peak Surge Current (1 $\mu\text{s}$ pulse)	A	1.0	1.0
$P_T$	Total Power Dissipation	mW	250	825
$P_{\text{INV}}$	Peak Inverse Voltage	V	30	30
$T_J$	Junction Temperature	$^\circ\text{C}$	150	150
$T_{\text{STG}}$	Storage Temperature	$^\circ\text{C}$	-65 to 150	-65 to 150
$\theta_{\text{JC}}$	Thermal Resistance, junction to lead	$^\circ\text{C/W}$	500	150

#### Note:

1. Operation in excess of any one of these conditions may result in permanent damage to the device.

### Linear and Non-linear SPICE Model<sup>[2]</sup>

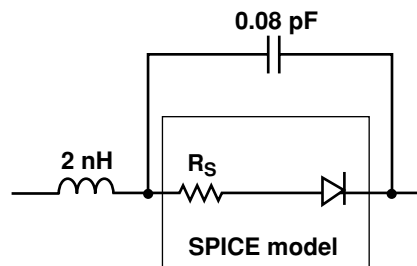

#### Note:

2. To effectively model the packaged HBAT-540x product, please refer to Application Note AN1124.

### SPICE Parameters

Parameter	Unit	Value
BV	V	40
CJO	pF	3.0
EG	eV	0.55
IBV	A	10E-4
IS	A	1.0E-7
N		1.0
RS	$\Omega$	2.4
PB	V	0.6
PT		2
M		0.5

### HBAT-540x DC Electrical Specifications, $T_A = +25^\circ\text{C}$ <sup>[1]</sup>

Part Number HBAT-	Package Marking Code <sup>[2]</sup>	Lead Code	Configuration	Package	Maximum Forward Voltage $V_F$ (mV)	Minimum Breakdown Voltage $V_{\text{BR}}$ (V)	Typical Capacitance $C_T$ (pF)	Typical Series Resistance $R_S$ ( $\Omega$ )	Maximum Eff. Carrier Lifetime $\tau$ (ps)
-5400	V0	0	Single	SOT-23	800 <sup>[3]</sup>	30 <sup>[4]</sup>	3.0 <sup>[5]</sup>	2.4	100 <sup>[6]</sup>
-540B		B		SOT-323 (3-lead SC-70)					
-5402	V2	2	Series	SOT-23					
-540C		C		SOT-323 (3-lead SC-70)					
-540E	V3	E	Common Anode	SOT-323 (3-lead SC-70)					
-540F	V4	F	Common Cathode	SOT-323 (3-lead SC-70)					

#### Notes:

1.  $T_A = +25^\circ\text{C}$ , where  $T_A$  is defined to be the temperature at the package pins where contact is made to the circuit board.
2. Package marking code is laser marked.
3.  $I_F = 100$  mA; 100% tested
4.  $I_F = 100$   $\mu\text{A}$ ; 100% tested
5.  $V_F = 0$ ;  $f = 1$  MHz
6. Measured with Karkauer method at 20 mA guaranteed by design.

## Typical Performance

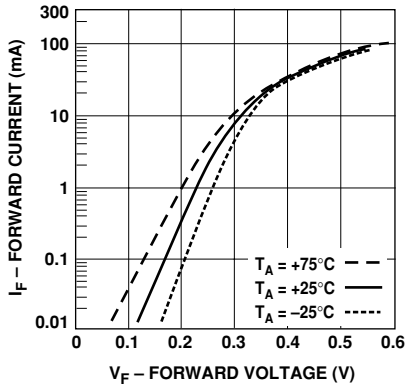

Figure 1. Forward Current vs. Forward Voltage at Temperature for HBAT-5400 and HBAT-5402.

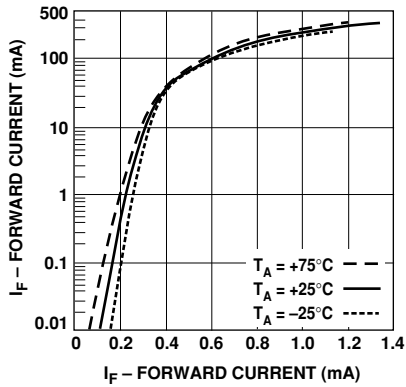

Figure 2. Forward Current vs. Forward Voltage at Temperature for HBAT-540B, -540C, -540E, and -540F.

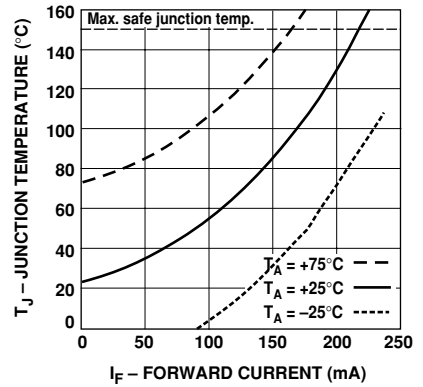

Figure 3. Junction Temperature vs. Current as a Function of Heat Sink Temperature for HBAT-5400 and HBAT-5402. Note: Data is calculated from SPICE parameters.

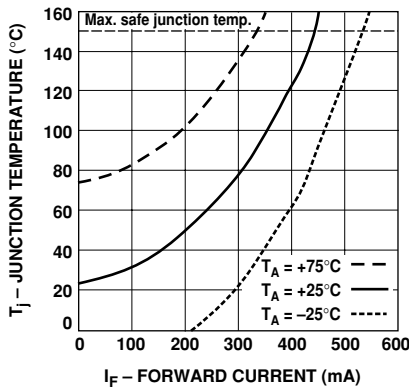

Figure 4. Junction Temperature vs. Current as a Function of Heat Sink Temperature for HBAT-540B, -540C, -540E, and -540F.

Note: Data is calculated from SPICE parameters.

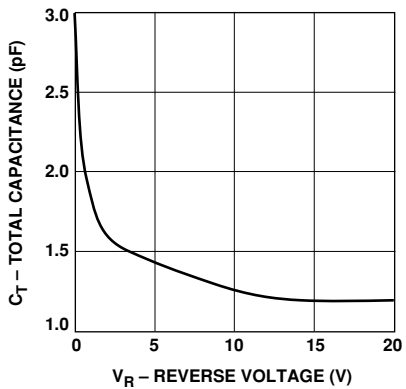
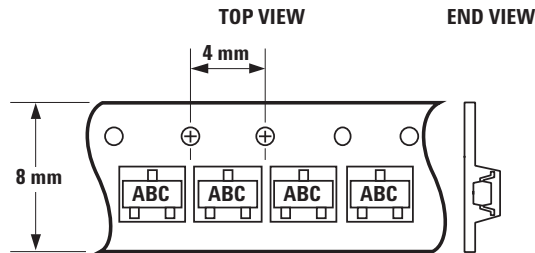
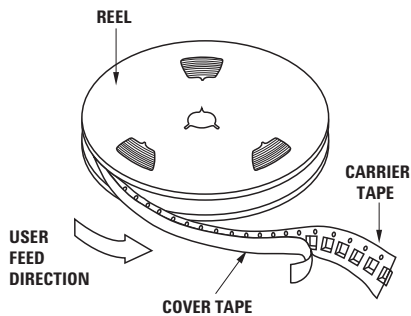

Figure 5. Total Capacitance vs. Reverse Voltage.

## Device Orientation For Outlines SOT-23/323



Note: "AB" represents package marking code.  
"C" represents date code.

### Package Dimensions Outline SOT-23

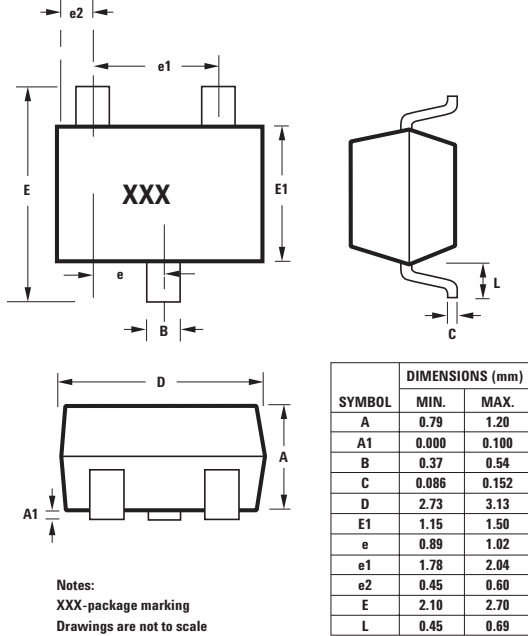

### Recommended PCB Pad Layout for Agilent's SOT-23 Products

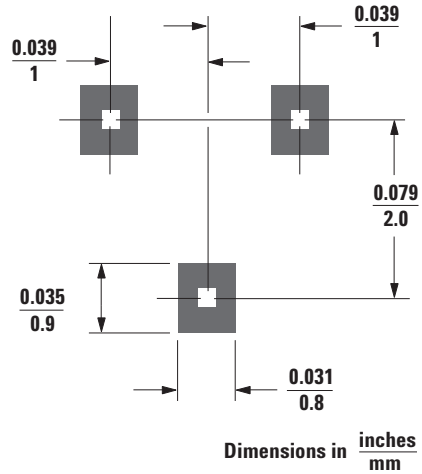

### Tape Dimensions and Product Orientation For Outline SOT-23

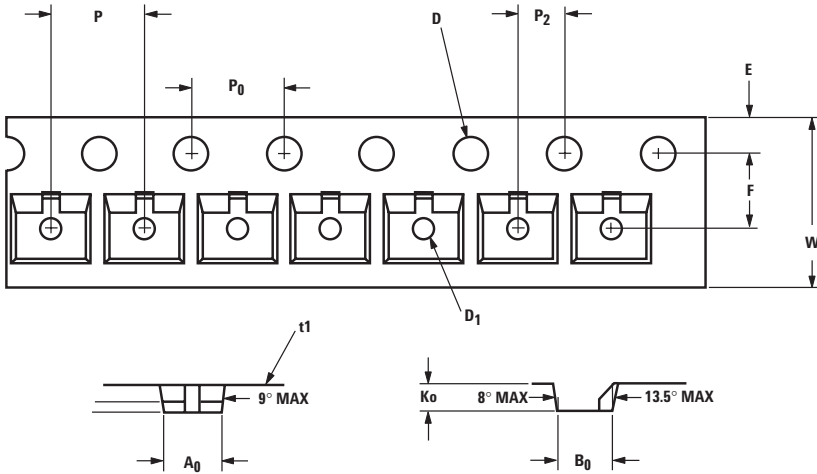

DESCRIPTION		SYMBOL	SIZE (mm)	SIZE (INCHES)
CAVITY	LENGTH	A <sub>0</sub>	3.15 ± 0.10	0.124 ± 0.004
	WIDTH	B <sub>0</sub>	2.77 ± 0.10	0.109 ± 0.004
	DEPTH	K <sub>0</sub>	1.22 ± 0.10	0.048 ± 0.004
	PITCH	P	4.00 ± 0.10	0.157 ± 0.004
	BOTTOM HOLE DIAMETER	D <sub>1</sub>	1.00 + 0.05	0.039 ± 0.002
PERFORATION	DIAMETER	D	1.50 + 0.10	0.059 + 0.004
	PITCH	P <sub>0</sub>	4.00 ± 0.10	0.157 ± 0.004
	POSITION	E	1.75 ± 0.10	0.069 ± 0.004
CARRIER TAPE	WIDTH	W	8.00 + 0.30 - 0.10	0.315 + 0.012 - 0.004
	THICKNESS	t <sub>1</sub>	0.229 ± 0.013	0.009 ± 0.0005
DISTANCE BETWEEN CENTERLINE	CAVITY TO PERFORATION (WIDTH DIRECTION)	F	3.50 ± 0.05	0.138 ± 0.002
	CAVITY TO PERFORATION (LENGTH DIRECTION)	P <sub>2</sub>	2.00 ± 0.05	0.079 ± 0.002

### Package Dimensions Outline SOT-323 (SC-70 3 Lead)

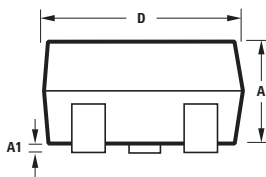
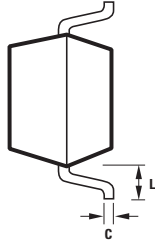
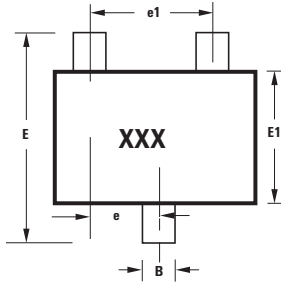

SYMBOL	DIMENSIONS (mm)	
	MIN.	MAX.
A	0.80	1.00
A1	0.00	0.10
B	0.15	0.40
C	0.10	0.20
D	1.80	2.25
E1	1.10	1.40
e	0.65 typical	
e1	1.30 typical	
E	1.80	2.40
L	0.425 typical	

Notes:  
XXX-package marking  
Drawings are not to scale

### Recommended PCB Pad Layout for Agilent's SC70 3L/SOT-323 Products

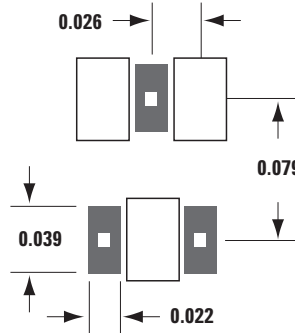

Dimensions in inches

### Tape Dimensions and Product Orientation For Outline SOT-323 (SC-70 3 Lead)

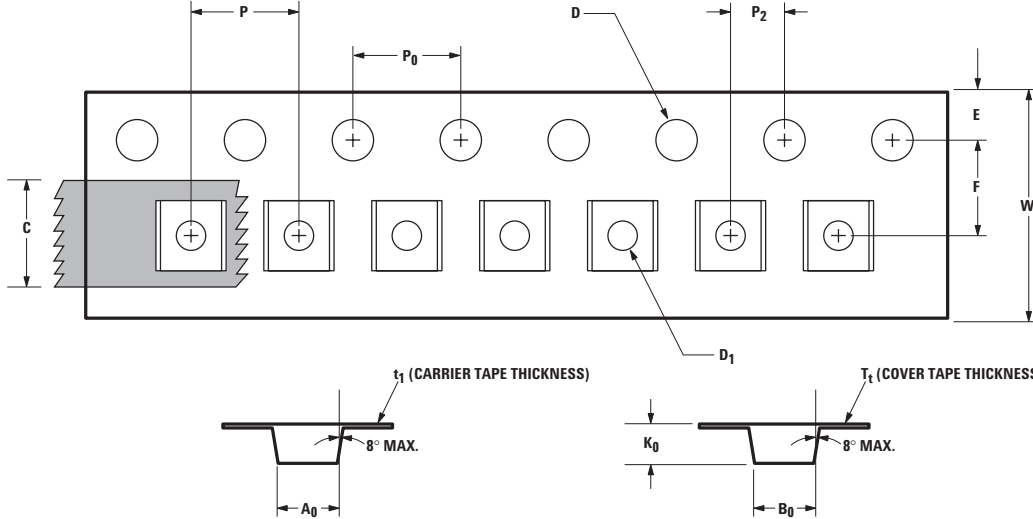

DESCRIPTION		SYMBOL	SIZE (mm)	SIZE (INCHES)
CAVITY	LENGTH	A <sub>0</sub>	2.40 ± 0.10	0.094 ± 0.004
	WIDTH	B <sub>0</sub>	2.40 ± 0.10	0.094 ± 0.004
	DEPTH	K <sub>0</sub>	1.20 ± 0.10	0.047 ± 0.004
	PITCH	P	4.00 ± 0.10	0.157 ± 0.004
	BOTTOM HOLE DIAMETER	D <sub>1</sub>	1.00 + 0.25	0.039 + 0.010
PERFORMANCE	DIAMETER	D	1.55 ± 0.05	0.061 ± 0.002
	PITCH	P <sub>0</sub>	4.00 ± 0.10	0.157 ± 0.004
	POSITION	E	1.75 ± 0.10	0.069 ± 0.004
CARRIER TAPE	WIDTH	W	8.00 ± 0.30	0.315 ± 0.012
	THICKNESS	t <sub>1</sub>	0.254 ± 0.02	0.0100 ± 0.0008
COVER TAPE	WIDTH	C	5.4 ± 0.10	0.205 ± 0.004
	TAPE THICKNESS	T <sub>1</sub>	0.062 ± 0.001	0.0025 ± 0.00004
DISTANCE	CAVITY TO PERFORATION (WIDTH DIRECTION)	F	3.50 ± 0.05	0.138 ± 0.002
	CAVITY TO PERFORATION (LENGTH DIRECTION)	P <sub>2</sub>	2.00 ± 0.05	0.079 ± 0.002

## Applications Information

### Schottky Diode Fundamentals

The HBAT-540x series of clipping/clamping diodes are Schottky devices. A Schottky device is a rectifying, metal-semiconductor contact formed between a metal and an n-doped or a p-doped semiconductor. When a metal-semiconductor junction is formed, free electrons flow across the junction from the semiconductor and fill the free-energy states in the metal. This flow of electrons creates a depletion or potential across the junction. The difference in energy levels between semiconductor and metal is called a Schottky barrier.

P-doped, Schottky-barrier diodes excel at applications requiring ultra low turn-on voltage (such as zero-biased RF detectors). But their very low, breakdown-voltage and high series-resistance make them unsuitable for the clipping and clamping applications involving high forward currents and high reverse voltages. Therefore, this discussion will focus entirely on n-doped Schottky diodes.

Under a forward bias (metal connected to positive in an n-doped Schottky), or forward voltage,  $V_F$ , there are many electrons with enough thermal energy to cross the barrier potential into the metal. Once the applied bias exceeds the built-in potential of the junction, the forward current,  $I_F$ , will increase rapidly as  $V_F$  increases.

When the Schottky diode is reverse biased, the potential barrier for electrons becomes large; hence, there is a small probability that an electron will have sufficient thermal energy to

cross the junction. The reverse leakage current will be in the nanoampere to microampere range, depending upon the diode type, the reverse voltage, and the temperature.

In contrast to a conventional p-n junction, current in the Schottky diode is carried only by majority carriers. Because no minority carrier charge storage effects are present, Schottky diodes have carrier lifetimes of less than 100 ps and are extremely fast switching semiconductors. Schottky diodes are used as rectifiers at frequencies of 50 GHz and higher.

Another significant difference between Schottky and p-n diodes is the forward voltage drop. Schottky diodes have a threshold of typically 0.3 V in comparison to that of 0.6 V in p-n junction diodes. See Figure 6.

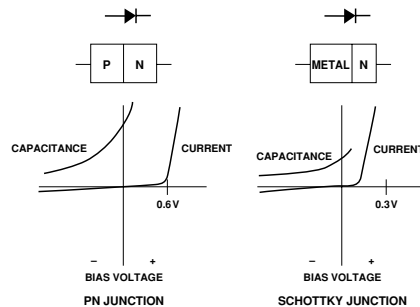

**Figure 6.**

Through the careful manipulation of the diameter of the Schottky contact and the choice of metal deposited on the n-doped silicon, the important characteristics of the diode (junction capacitance,  $C_J$ ; parasitic series resistance,  $R_S$ ; breakdown voltage,  $V_{BR}$ ; and forward voltage,  $V_F$ ) can be optimized for specific applications. The HSMS-270x series and HBAT-540x series of diodes are a case in point.

Both diodes have similar barrier heights; and this is indicated by corresponding values of saturation current,  $I_S$ . Yet, different contact diameters and epitaxial-layer thickness result in very different values of junction capacitance,  $C_J$  and  $R_S$ . This is portrayed by their SPICE parameters in Table 1.

**Table 1. HBAT-540x and HSMS-270x SPICE Parameters.**

Parameter	HBAT-540x	HSMS-270x
BV	40 V	25 V
CJ0	<b>3.0 pF</b>	<b>6.7 pF</b>
EG	0.55 eV	0.55 eV
IBV	10E-4 A	10E-4 A
IS	1.0E-7 A	1.4E-7 A
N	1.0	1.04
RS	<b>2.4 <math>\Omega</math></b>	<b>0.65 <math>\Omega</math></b>
PB	0.6 V	0.6 V
PT	2	2
M	0.5	0.5

At low values of  $I_F \leq 1$  mA, the forward voltages of the two diodes are nearly identical. However, as current rises above 10 mA, the lower series resistance of the HSMS-270x allows for a much lower forward voltage. This gives the HSMS-270x a much higher current handling capability. The trade-off is a higher value of junction capacitance. The forward voltage and current plots illustrate the differences in these two Schottky diodes, as shown in Figure 7.

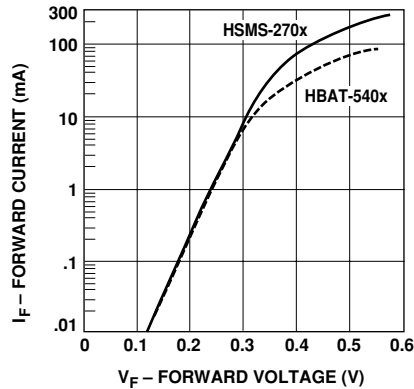

Figure 7. Forward Current vs. Forward Voltage at 25°C.

Because the automatic, pick-and-place equipment used to assemble these products selects dice from adjacent sites on the wafer, the two diodes which go into the HBAT-5402 or HBAT-540C (series pair) are closely matched — without the added expense of testing and binning.

### Current Handling in Clipping/Clamping Circuits

The purpose of a clipping/clamping diode is to handle high currents, protecting delicate circuits downstream of the diode. Current handling capacity is determined by two sets of characteristics, those of the chip or device itself and those of the package into which it is mounted.

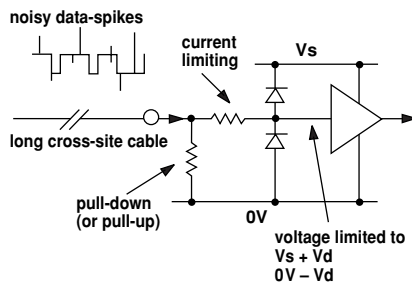

Figure 8. Two Schottky Diodes Are Used for Clipping/Clamping in a Circuit.

Consider the circuit shown in Figure 8, in which two Schottky diodes are used to protect a circuit from noise spikes on a stream of digital data. The ability of the diodes to limit the voltage spikes is related to their ability to sink the associated current spikes. The importance of current handling capacity is shown in Figure 9, where the forward voltage generated by a forward current is compared in two diodes. The first is a conventional Schottky diode of the type generally used in RF circuits, with an  $R_S$  of 7.7  $\Omega$ . The second is a Schottky diode of identical characteristics, save the  $R_S$  of 1.0  $\Omega$ . For the conventional diode, the relatively high value of  $R_S$  causes the voltage across the diode's terminals to rise as current increases. The power dissipated in the diode heats the junction, causing  $R_S$  to climb, giving rise to a runaway thermal condition. In the second diode with low  $R_S$ , such heating does not take place and the voltage across the diode terminals is maintained at a low limit even at high values of current.

Maximum reliability is obtained in a Schottky diode when the steady state junction temperature is maintained at or below 150°C, although brief excursions to higher junction temperatures can be tolerated with no significant impact upon mean-time-to-failure, MTTF. In order to compute the junction temperature, Equations (1) and (3) below must be simultaneously solved.

$$I_F = I_S \left[ e^{\frac{11600 (V_F - I_F R_S)}{n T_J}} - 1 \right] \quad (1)$$

$$I_S = I_0 \left( \frac{T_J}{298} \right)^{\frac{2}{n}} e^{-4060 \left( \frac{1}{T_J} - \frac{1}{298} \right)} \quad (2)$$

$$T_J = V_F I_F \theta_{JC} + T_A \quad (3)$$

where:

$I_F$  = forward current

$I_S$  = saturation current

$V_F$  = forward voltage

$R_S$  = series resistance

$T_J$  = junction temperature

$I_0$  = saturation current at 25°C

$n$  = diode ideality factor

$\theta_{JC}$  = thermal resistance from junction to case (diode lead)

=  $\theta_{\text{package}} + \theta_{\text{chip}}$

$T_A$  = ambient (diode lead) temperature

Equation (1) describes the forward V-I curve of a Schottky diode. Equation (2) provides the value for the diode's saturation current, which value is plugged into (1). Equation (3) gives the value of junction temperature as a function of power dissipated in the diode and ambient (lead) temperature.

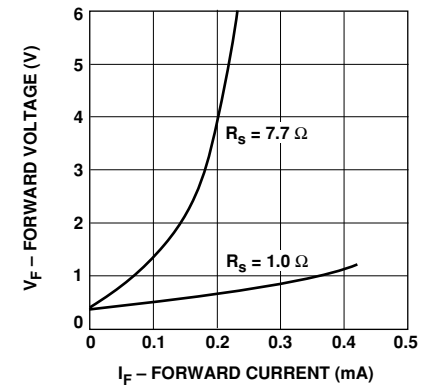

Figure 9. Comparison of Two Diodes.

The key factors in these equations are:  $R_S$ , the series resistance of the diode where heat is generated under high current conditions;  $\theta_{chip}$ , the chip thermal resistance of the Schottky die; and  $\theta_{package}$ , or the package thermal resistance.

$R_S$  for the HBAT-540x family of diodes is typically 2.4  $\Omega$ , other than the HSMS-270x family, this is the lowest of any Schottky diode available. Chip thermal resistance is typically 40°C/W; the thermal resistance of the iron-alloy-leadframe, SOT-23 package is typically 460°C/W; and the thermal resistance of the copper-leadframe, SOT-323 package is typically 110°C/W. The impact of

package thermal resistance on the current handling capability of these diodes can be seen in Figures 3 and 4. Here the computed values of junction temperature vs. forward current are shown for three values of ambient temperature. The SOT-323 products, with their copper leadframes, can safely handle almost twice the current of the larger SOT-23 diodes. Note that the term “ambient temperature” refers to the temperature of the diode’s leads, not the air around the circuit board. It can be seen that the HBAT-540B and HBAT-540C products in the SOT-323 package will safely withstand a steady-state forward

current of 330 mA when the diode’s terminals are maintained at 75°C.

For pulsed currents and transient current spikes of less than one microsecond in duration, the junction does not have time to reach thermal steady state. Moreover, the diode junction may be taken to temperatures higher than 150°C for short time periods without impacting device MTTF. Because of these factors, higher currents can be safely handled. The HBAT-540x family has the second highest current handling capability of any Agilent diode, next to the HSMS-270x series.

**www.agilent.com/semiconductors**

For product information and a complete list of distributors, please go to our web site.

For technical assistance call:

Americas/Canada: +1 (800) 235-0312 or (916) 788-6763

Europe: +49 (0) 6441 92460

China: 10800 650 0017

Hong Kong: (65) 6756 2394

India, Australia, New Zealand: (65) 6755 1939

Japan: (+81 3) 3335-8152(Domestic/International), or 0120-61-1280(Domestic Only)

Korea: (65) 6755 1989

Singapore, Malaysia, Vietnam, Thailand, Philippines, Indonesia: (65) 6755 2044

Taiwan: (65) 6755 1843

Data subject to change.

Copyright © 2005 Agilent Technologies, Inc.

Obsoletes 5989-0472EN

September 28, 2005

5989-2490EN

**Part Number Ordering Information**

Part Number	No. of Devices	Container
HBAT-5400-BLK	100	Antistatic Bag
HBAT-5400-TR1	3,000	7" Reel
HBAT-5400-TR2	10,000	13" Reel
HBAT-5402-BLK	100	Antistatic Bag
HBAT-5402-TR1	3,000	7" Reel
HBAT-5402-TR2	10,000	13" Reel
HBAT-540B-BLK	100	Antistatic Bag
HBAT-540B-TR1	3,000	7" Reel
HBAT-540B-TR2	10,000	13" Reel
HBAT-540C-BLK	100	Antistatic Bag
HBAT-540C-TR1	3,000	7" Reel
HBAT-540C-TR2	10,000	13" Reel
HBAT-540E-BLK	100	Antistatic Bag
HBAT-540E-TR1	3,000	7" Reel
HBAT-540E-TR2	10,000	13" Reel
HBAT-540F-BLK	100	Antistatic Bag
HBAT-540F-TR1	3,000	7" Reel
HBAT-540F-TR2	10,000	13" Reel

**Note:** For lead-free option, the part number will have the character "G" at the end, eg. HBAT-540x-TR2G for a 10,000 lead-free reel.



**Agilent Technologies**