

STANDARD RECOVERY DIODES

Stud Version

Features

- Wide current range
- High voltage ratings up to 2500V
- High surge current capabilities
- Stud cathode and stud anode version

300A

STD REC
DIODE
STUD INFO

Typical Applications

- Converters
- Power supplies
- Machine tool controls
- High power drives
- Medium traction applications

Major Ratings and Characteristics

Parameters	301U(R)		Units
	80 to 200	250	
$I_{F(AV)}$	330	300	A
@ T_C	120	120	°C
$I_{F(RMS)}$	520	470	A
I_{FSM} @ 50Hz	8250	6050	A
@ 60Hz	8640	6335	A
I^2t @ 50Hz	340	183	KA ² s
@ 60Hz	311	167	KA ² s
V_{RRM} range	800 to 2000	2500	V
T_J	- 40 to 180	- 40 to 180	°C

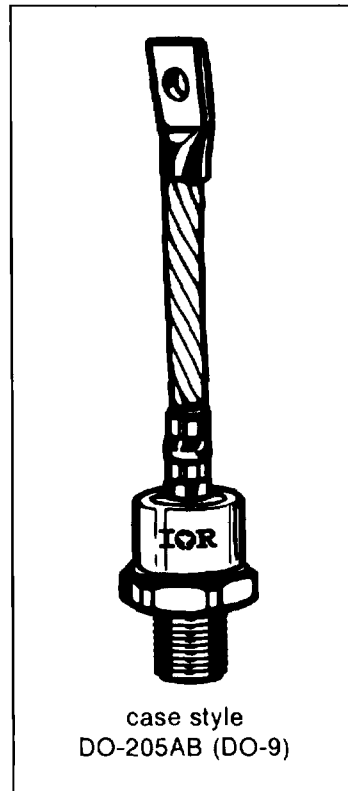

ELECTRICAL SPECIFICATIONS**Voltage Ratings**

Type number	Voltage Code	V_{RRM} , maximum repetitive peak reverse voltage V	V_{RSM} , maximum non-repetitive peak rev. voltage V	I_{RRM} max. @ $T_J = T_J$ max. mA
301U(R)	80	800	900	15
	120	1200	1300	
	160	1600	1700	
	200	2000	2100	
	250	2500	2600	

Forward Conduction

Parameter	301U(R)		Units	Conditions		
	80 to 200	250				
$I_{F(AV)}$ Max. average forward current @ Case temperature	330	300	A	180° conduction, half sine wave		
	120	120	°C			
$I_{F(RMS)}$ Max. RMS forward current	520	470	A	DC @ $T_C = 115^\circ\text{C}$ (08 to 20), $T_C = 102^\circ\text{C}$ (25)		
I_{FSM} Max. peak, one-cycle forward, non-repetitive surge current	8250	6050	A	t = 10ms	No voltage reappplied	Sinusoidal half wave, Initial $T_J = T_J$ max.
	8640	6335		t = 8.3ms	reappplied	
	6940	5090		t = 10ms	100% V_{RRM}	
	7270	5330		t = 8.3ms	reappplied	
I^2t Maximum I^2t for fusing	340	183	KA ² s	t = 10ms	No voltage reappplied	
	311	167		t = 8.3ms	reappplied	
	241	129		t = 10ms	100% V_{RRM}	
	220	118		t = 8.3ms	reappplied	
$I^2\sqrt{t}$ Maximum $I^2\sqrt{t}$ for fusing	3400	1830	KA ² √s	t = 0.1 to 10ms, no voltage reappplied		
$V_{F(TO)1}$ Low level value of threshold voltage	0.77	0.90	V	$(16.7\% \times \pi \times I_{F(AV)} < I < \pi \times I_{F(AV)}), T_J = T_J$ max.		
$V_{F(TO)2}$ High level value of threshold voltage	0.84	0.97		$(I > \pi \times I_{F(AV)}), T_J = T_J$ max.		
$r_{\theta 1}$ Low level value of forward slope resistance	0.49	0.59	mΩ	$(16.7\% \times \pi \times I_{F(AV)} < I < \pi \times I_{F(AV)}), T_J = T_J$ max.		
$r_{\theta 2}$ High level value of forward slope resistance	0.49	0.55		$(I > \pi \times I_{F(AV)}), T_J = T_J$ max.		
V_{FM} Max. forward voltage drop	1.22	1.46	V	$I_{pk} = 942\text{A}, T_J = T_J$ max, $t_p = 10\text{ms}$ sinusoidal wave		

Thermal and Mechanical Specifications

Parameter	301U(R)	Units	Conditions
T_J Max. junction operating temperature range	-40 to 180	°C	
T_{stg} Max. storage temperature range	-40 to 200		
R_{thJC} Max. thermal resistance, junction to case	0.14	K/W	DC operation
R_{thCS} Max. thermal resistance, case to heatsink	0.08		Mounting surface, smooth, flat and greased
T Max. allowed mounting torque +0 -20%	37	Nm	Not lubricated threads
	28		Lubricated threads
wt Weight	301U	250 ± 5	
	303U	152 ± 5	
	305U	177 ± 5	
	307U	197 ± 5	
	309U	160 ± 5	
Case style	DO-205AB (DO-9)		See Outline Table

STD REC
DIODE
STUD MTD

ΔR_{thJC} Conduction

(The following table shows the increment of thermal resistance R_{thJC} when devices operate at different conduction angles than DC)

Conduction angle	Sinusoidal conduction		Rectangular conduction		Units	Conditions
	80 to 200	250	00 to 200	250		
180°	0.015	0.015	0.011	0.011	K/W	$T_J = T_J \text{ max.}$
120°	0.018	0.018	0.019	0.019		
90°	0.023	0.023	0.025	0.025		
60°	0.034	0.034	0.035	0.035		
30°	0.056	0.056	0.057	0.057		

Ordering Information Table

Device Code

30	1	U	A	250	P5
①	②	③	④	⑤	⑥

- 1** - 30 = Essential Part Number
- 2** - 1 = Standard Device
- 3 = Top Threaded version
- 5 = Type for rotating application with Top Threaded version 3/8 16UNC-2A
- 7 = Type for rotating application with flexible lead
- 9 = Type for rotating application with Top Threaded version 3/8 24UNF
- 3** - U = Stud Normal Polarity (Cathode to Stud)
UR = Stud Reverse Polarity (Anode to Stud)
- 4** - A = Max. Leakage selection $I_{RRM} = 2\text{mA } T_J = 25^\circ\text{C}$
None = Std. Leakage selection $I_{RRM} = 10\text{mA } T_J = 25^\circ\text{C}$
- 5** - Voltage code: Code x 10 = V_{RRM} (See Voltage Ratings table)
- 6** - P. = Forward selection
None = Standard Forward selection

RANGE	I_{FM} $T_J = 25^\circ\text{C}$ (A)	V_{FM} min. (V)	V_{FM} max. (V)
P2 *	1000	1.16	1.25
P3 *		1.26	1.30
P4		1.31	1.40
P5		1.41	1.45

* 2500V not available

301U(R) Series

Outline Table

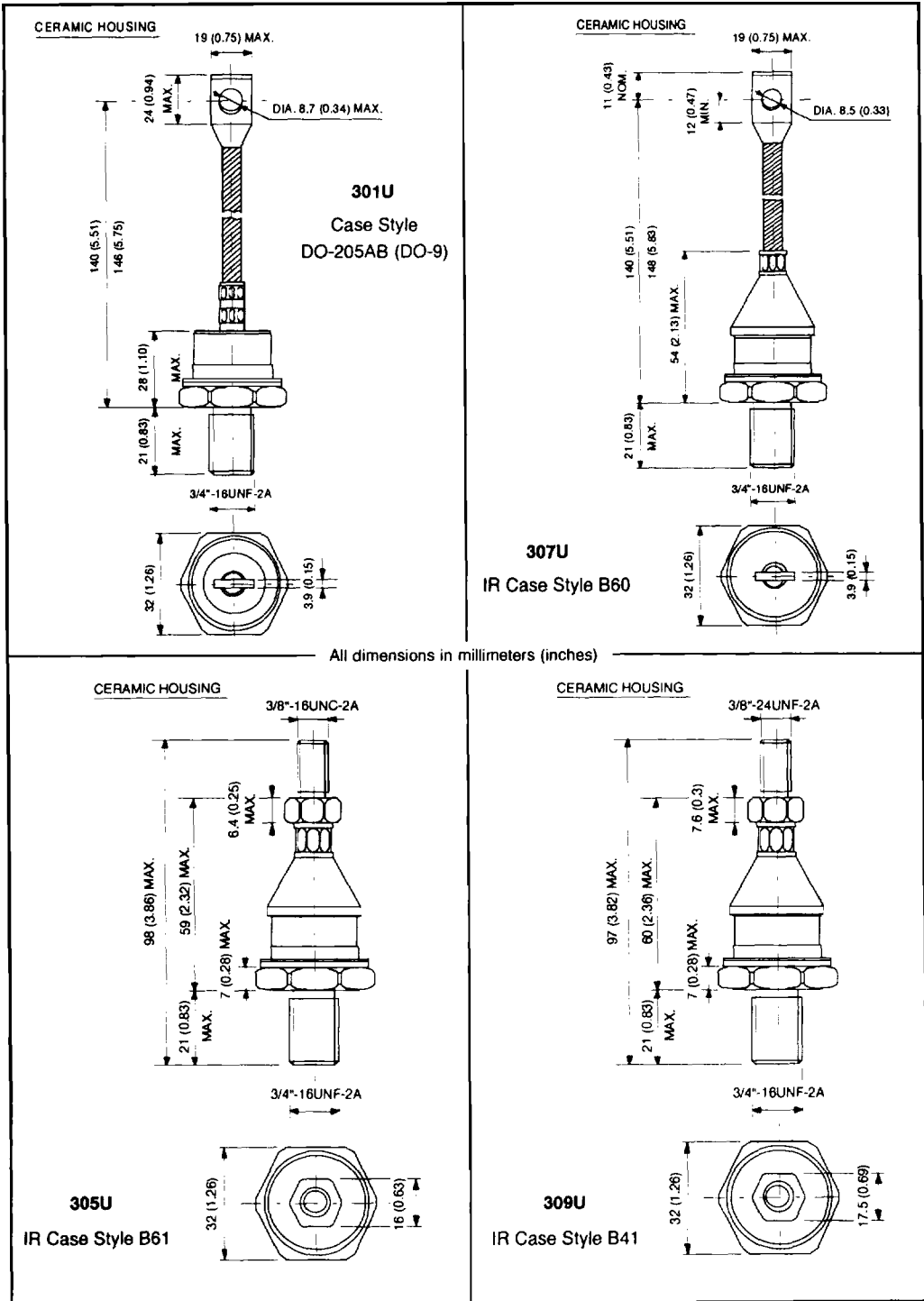

Outline Table

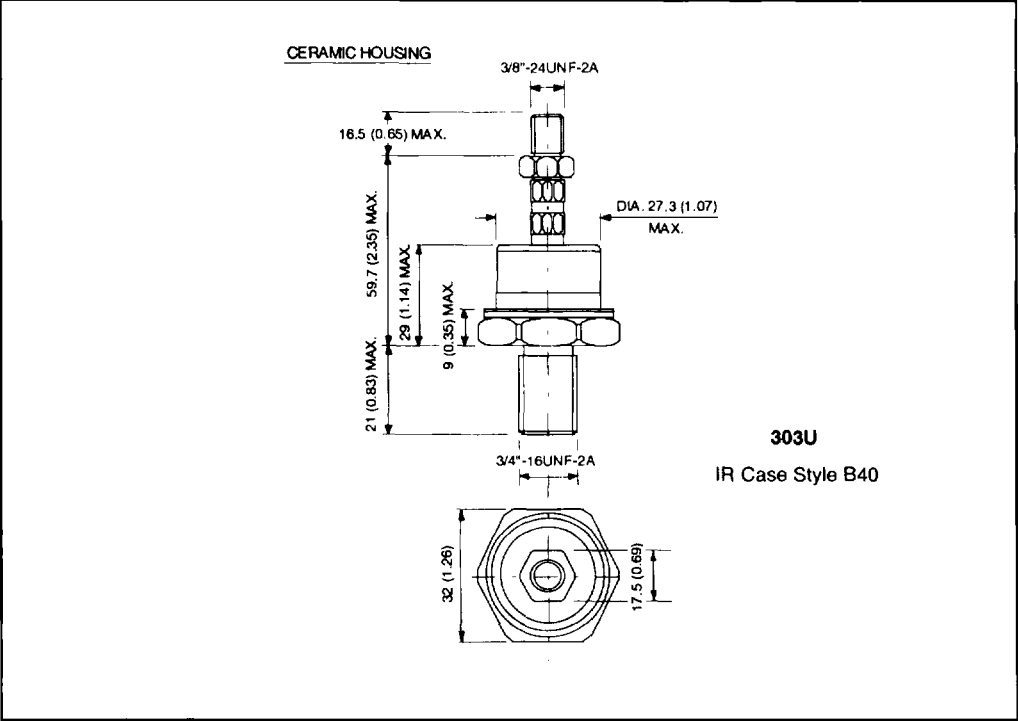

STD REC
DIODE
STUD MTD

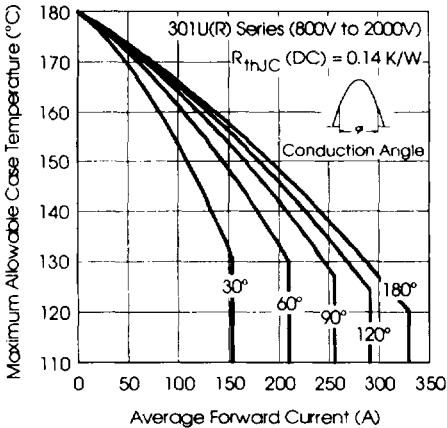

Fig. 1 - Current Ratings Characteristics

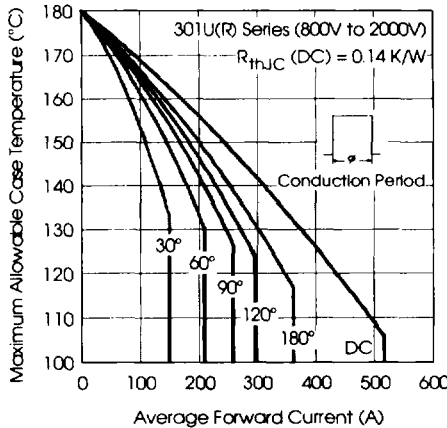

Fig. 2 - Current Ratings Characteristics

301U(R) Series

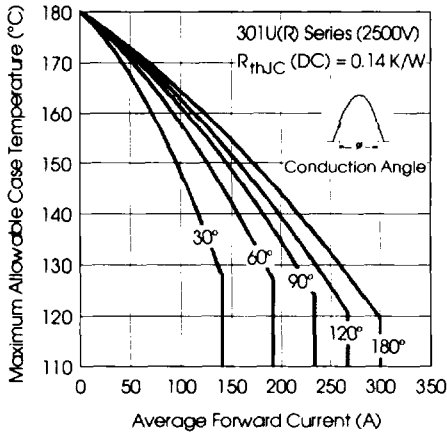

Fig. 3 - Current Ratings Characteristics

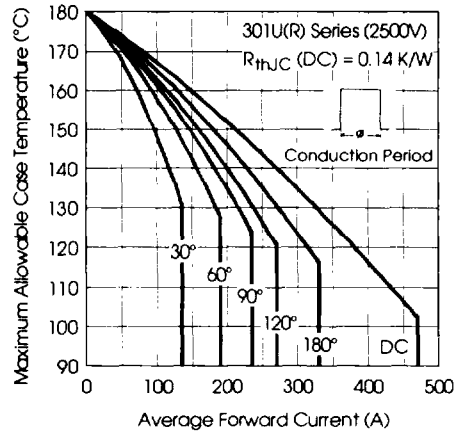

Fig. 4 - Current Ratings Characteristics

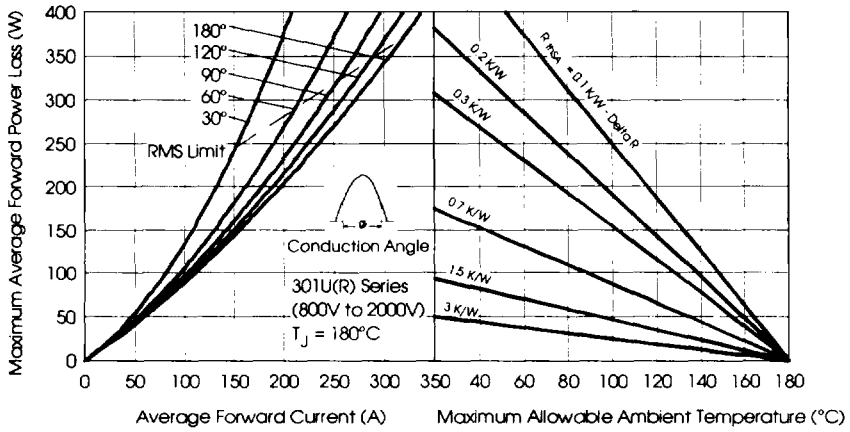

Fig. 5 - Forward Power Loss Characteristics

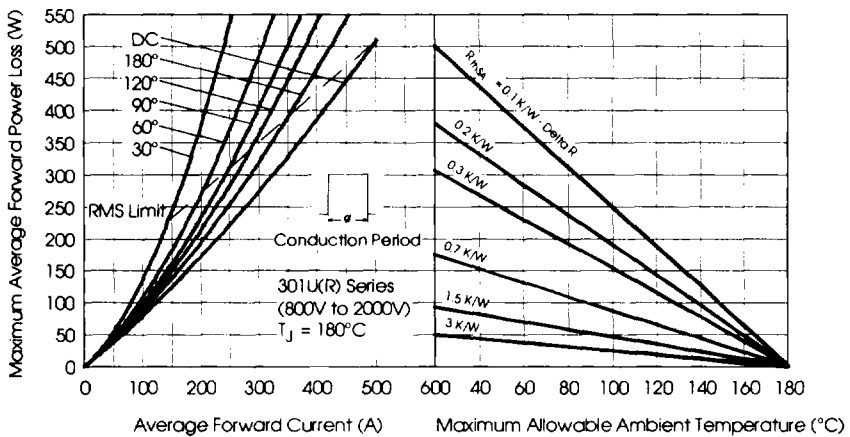

Fig. 6 - Forward Power Loss Characteristics

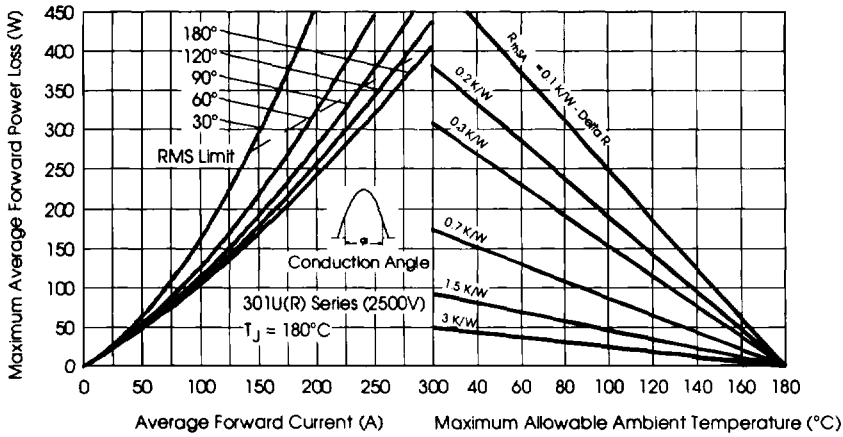

Fig. 7 - Forward Power Loss Characteristics

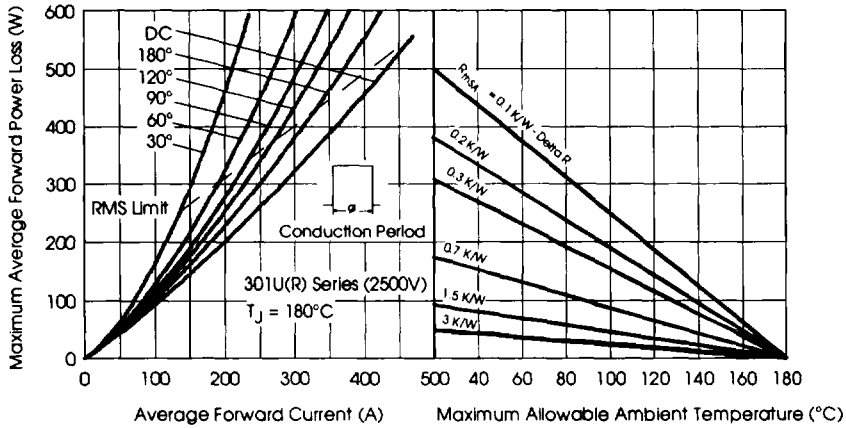

Fig. 8 - Forward Power Loss Characteristics

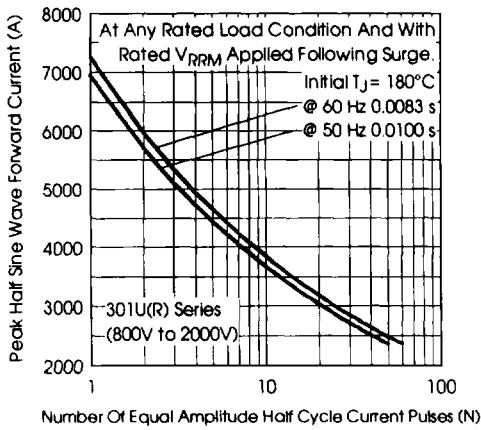

Fig. 9 - Maximum Non-Repetitive Surge Current

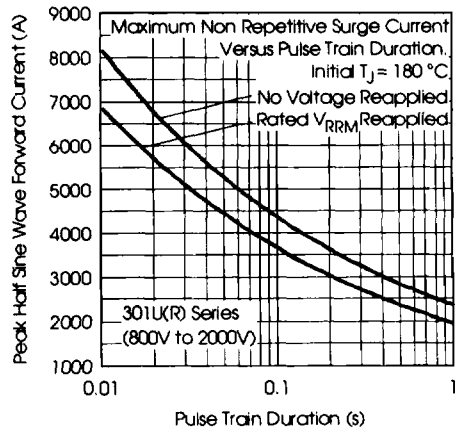

Fig. 10 - Maximum Non-Repetitive Surge Current

STD REC
DIODE
STUD MTD

301U(R) Series

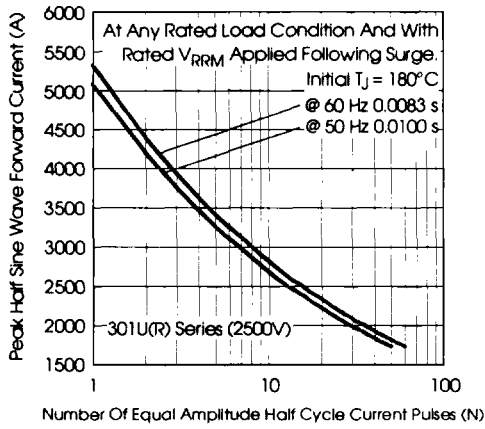

Fig. 11 - Maximum Non-Repetitive Surge Current

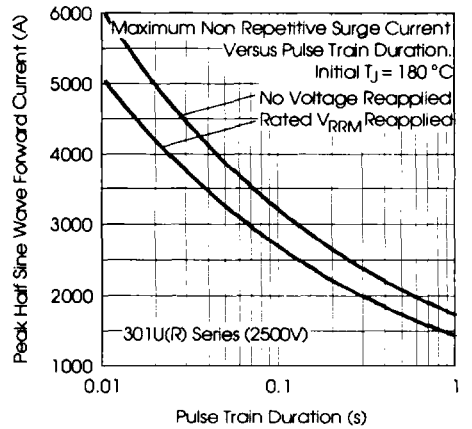

Fig. 12 - Maximum Non-Repetitive Surge Current

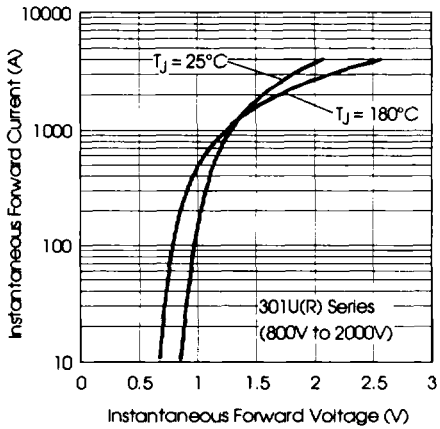

Fig. 13 - Forward Voltage Drop Characteristics

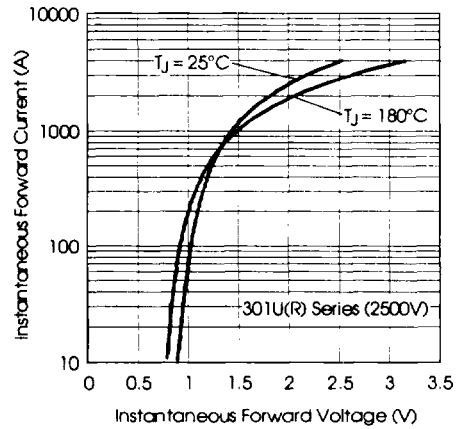

Fig. 14 - Forward Voltage Drop Characteristics

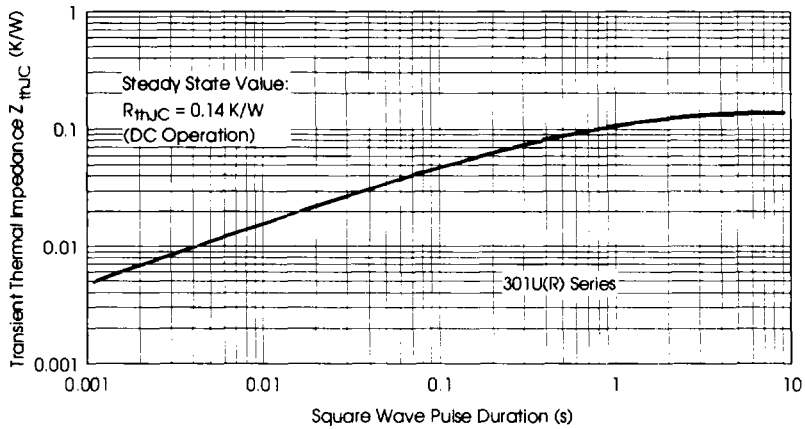

Fig. 15 - Thermal Impedance $Z_{\theta Jc}$ Characteristic