

RoHS  **216 Series, 5 x 20 mm, Fast-Acting Fuse**



Description

5x20mm fast-acting ceramic body cartridge fuse designed to IEC specification.









Features

- Designed to International (IEC) Standards for use globally
- Meets the IEC 60127-2, sheet 1 specification
- for fast-acting fuses
- Available in cartridge and axial lead form
- RoHS compliant and lead-free

Applications

Used as supplementary protection in appliance or utilization equipment to provide individual protection for components or internal circuits.

Agency Approvals

| Agency | Agency File Number | Ampere Range |
|---|---|---|
|  | Cartridge Certificates: 1-5A NBK 080205-E10480A 6.3A-10A NBK 250702-E10480E 12.5A NBK 240108-JP1021C 16A NBK 240108-JP1021E | 1A – 16A |
| | Leaded Certificates: 1-5A NBK 080205-E10480B 6.3A-10A NBK 250702-E10480F 12.5A NBK 240108-JP1021D 16A NBK 240108-JP1021F | |
|  | Certificates: 2003010207079960 | 50mA – 6.3A |
|  | Certificates: SU05001-2013 | 1A – 10A |
|  | Recognised File: E10480 Guide: JDYX2 | 50mA – 10A 12.5A, 16A |
| | File: 029862 Acc. Class: LR1422-30 | |
|  | License: KM41462 | 1A – 6.3A |
|  | File: 1027156 8117 45 0147099 1020822 1027014 | 50mA – 125mA 160mA – 800mA 1A – 6.3A 8A – 10A 16A |
| | File: 1027156 8117 45 0147099 1020822 1027014 | 50mA – 125mA 160mA – 800mA 1A – 6.3A 8A – 10A 16A |
| | File: 1027156 8117 45 0147099 1020822 1027014 | 50mA – 125mA 160mA – 800mA 1A – 6.3A 8A – 10A 16A |
| | File: 1027156 8117 45 0147099 1020822 1027014 | 50mA – 125mA 160mA – 800mA 1A – 6.3A 8A – 10A 16A |
| | File: 1027156 8117 45 0147099 1020822 1027014 | 50mA – 125mA 160mA – 800mA 1A – 6.3A 8A – 10A 16A |
|  | License: 40013834 | 50mA – 6.3A *8A, *10A |
|  | License: 40016442 | *12.5A |
|  | | 50mA – 16A |

*Approval for Cartridge versions only

Electrical Characteristics for Series

| % of Ampere Rating | Ampere Rating | Opening Time |
|--------------------|------------------------|--------------------------------|
| 150% | 50mA – 4A | 60 minutes, Minimum |
| | 5A – 6.3A | 60 minutes, Minimum |
| | 8A – 16A | 30 minutes, Minimum |
| 210% | 50mA – 4A | 30 minutes, Maximum |
| | 5A – 6.3A 8A – 16A | 30 minutes, Maximum |
| 275% | 50mA – 4A 5A – 6.3A | 0.01 sec., Min.; 2 sec. Max. |
| | 8A – 16A | 0.04 sec., Min.; 20 sec. Max. |
| 400% | 50mA – 4A 5A – 6.3A | .003 sec., Min.; 0.3 sec. Max. |
| | 8A – 16A | .01 sec., Min.; 1.0 sec. Max. |
| 1000% | 50mA – 4A | .02 seconds, Maximum |
| | 5A – 6.3A | .02 seconds, Maximum |
| | 8A – 16A | .03 sec.onds, Maximum |

216 Series

Electrical Characteristics Specifications by Item

| Amp Code | Amp Rating (A) | Voltage Rating (V) | Interrupting Rating | Nominal Cold Resistance (Ohms) | Nominal Melting I ² t (A ² sec) | Nominal Voltage Drop at Rated Current (mV) | Nominal Power Dissipation at Rated Current (W) | Agency Approvals | | | | | | | | | |
|----------|----------------|--------------------|---------------------|--------------------------------|---|--|--|------------------|-----|----|----|---|----|----|-----|-----|----|
| | | | | | | | | UL | CCC | RU | SP | S | CE | UL | VDE | VDE | PS |
| .050 | 0.05 | 250 | 1500A@250Vac | 15.9000 | 0.00019 | 10000 | 1.6 | | x | x | x | x | x | | x | | |
| .063 | 0.063 | 250 | | 10.4500 | 0.00054 | 8800 | 1.6 | | x | x | x | x | x | | x | | |
| .080 | 0.08 | 250 | | 7.8850 | 0.00084 | 7600 | 1.6 | | x | x | x | x | x | | x | | |
| .100 | 0.1 | 250 | | 5.7925 | 0.00450 | 7000 | 1.6 | | x | x | x | x | x | | x | | |
| .125 | 0.125 | 250 | | 3.6750 | 0.00546 | 5000 | 1.6 | | x | x | x | x | x | | x | | |
| .160 | 0.16 | 250 | | 5.3490 | 0.00576 | 4300 | 1.6 | | x | x | x | x | x | | x | | |
| .200 | 0.2 | 250 | | 3.3500 | 0.00439 | 3500 | 1.6 | | x | x | x | x | x | | x | | |
| .250 | 0.25 | 250 | | 2.3500 | 0.00891 | 2800 | 2.5 | | x | x | x | x | x | | x | | |
| .315 | 0.315 | 250 | | 1.8500 | 0.01000 | 2500 | 2.5 | | x | x | x | x | x | | x | | |
| .400 | 0.4 | 250 | | 0.9065 | 0.04000 | 2000 | 2.5 | | x | x | x | x | x | | x | | |
| .500 | 0.5 | 250 | | 0.8660 | 0.16500 | 1800 | 2.5 | | x | x | x | x | x | | x | | |
| .630 | 0.63 | 250 | | 0.4650 | 0.17500 | 1500 | 2.5 | | x | x | x | x | x | | x | | |
| .800 | 0.8 | 250 | | 0.2950 | 0.28500 | 1200 | 2.5 | | x | x | x | x | x | | x | | |
| 001. | 1 | 250 | | 0.2370 | 0.18000 | 1000 | 2.5 | x | x | x | x | x | x | x | x | | x |
| 1.25 | 1.25 | 250 | | 0.1530 | 0.48000 | 800 | 4 | x | x | x | x | x | x | x | x | | x |
| 01.6 | 1.6 | 250 | | 0.1112 | 1.00500 | 600 | 4 | x | x | x | x | x | x | x | x | | x |
| 002. | 2 | 250 | | 0.0764 | 1.87000 | 500 | 4 | x | x | x | x | x | x | x | x | | x |
| 02.5 | 2.5 | 250 | | 0.0584 | 2.69500 | 400 | 4 | x | x | x | x | x | x | x | x | | x |
| 3.15 | 3.15 | 250 | | 0.0368 | 6.70000 | 350 | 4 | x | x | x | x | x | x | x | x | | x |
| 004. | 4 | 250 | | 0.0247 | 14.99500 | 300 | 4 | x | x | x | x | x | x | x | x | | x |
| 005. | 5 | 250 | 0.0183 | 27.46000 | 250 | 4 | x | x | x | x | x | x | x | x | | x | |
| 06.3 | 6.3 | 250 | 0.0137 | 56.43000 | 200 | 4 | x | x | x | x | x | x | x | x | | x | |
| 008. | 8 | 250 | 0.0123 | 64.31500 | 200 | 4 | x | | x | x | x | x | | x* | | x | |
| 010. | 10 | 250 | 0.0079 | 154.34000 | 200 | 4 | x | | x | x | x | x | | x* | | x | |
| 12.5 | 12.5 | 250 | 0.0057 | 235.00000 | 200 | 4 | | | x | x | | x | | | x* | x | |
| 016. | 16 | 250 | 0.0040 | 462.50000 | 200 | 4.5 | | | x | x | x | x | | | | x | |

* Approval for cartridge versions only.

Temperature Derating Curve

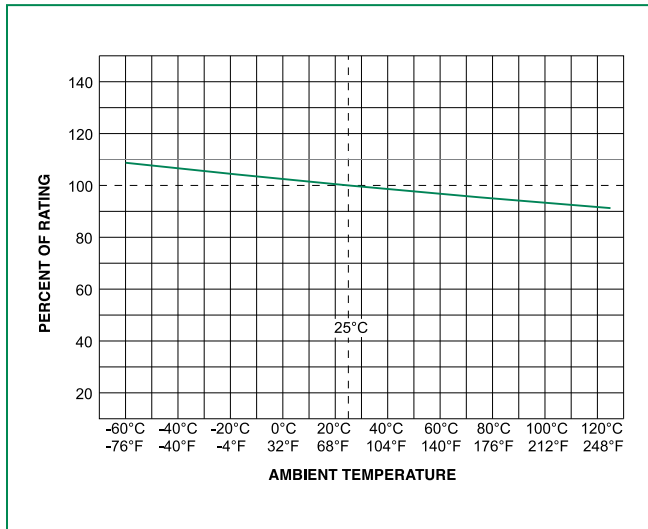

Average Time Current Curves

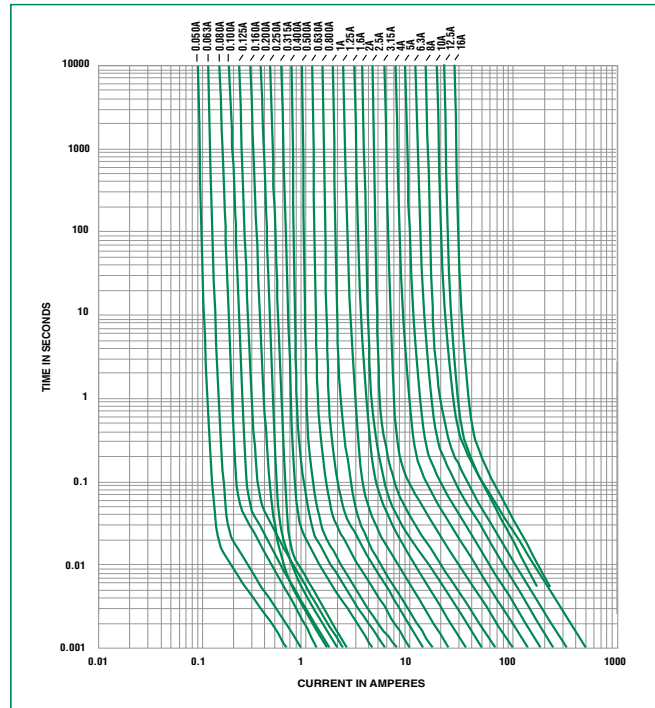

Soldering Parameters - Wave Soldering

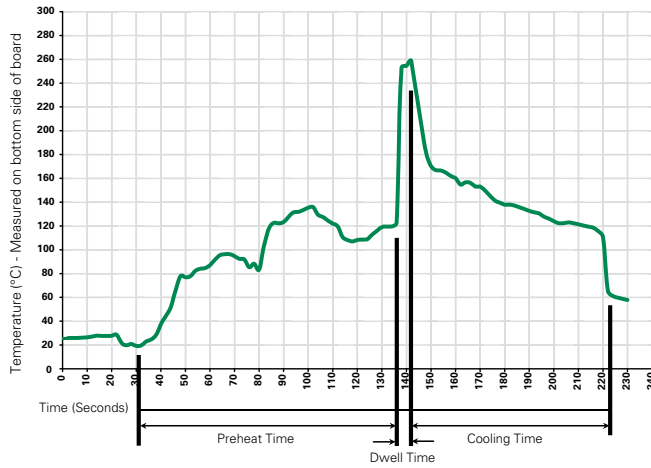

Recommended Process Parameters:

| Wave Parameter | Lead-Free Recommendation |
|---|--------------------------|
| Preheat: (Depends on Flux Activation Temperature) (Typical Industry Recommendation) | |
| Temperature Minimum: | 100° C |
| Temperature Maximum: | 150° C |
| Preheat Time: | 60-180 seconds |
| Solder Pot Temperature: | 260° C Maximum |
| Solder Dwell Time: | 2-5 seconds |

Recommended Hand-Solder Parameters:

Solder Iron Temperature: 350° C +/- 5° C
 Heating Time: 5 seconds max.

Note: These devices are not recommended for IR or Convection Reflow process.

Product Characteristics

| | |
|--------------------------|---|
| Material | Body: Ceramic Cap: Nickel-plated brass Leads: Tin-plated Copper Filler (160mA-16A): Sand |
| Terminal Strength | MIL-STD-202G, Method 211A, Test Condition A |
| Solderability | Reference IEC 60127 Second Edition 2003-01 Annex A |
| Product Marking | Cap 1: Brand logo, current and voltage rating Cap 2: Agency approval markings |
| Packaging | Available in Bulk (M=1000 pcs/pkg) or on Tape/Reel (MRET1=1000 pcs/reel) |

| | |
|------------------------------|---|
| Operating Temperature | -55°C to +125°C |
| Thermal Shock | MIL-STD-202G, Method 107G, Test Condition B: (5 cycles -65°C to +125°C) |
| Vibration | MIL-STD-202G, Method 201A |
| Humidity | MIL-STD-202G, Method 103B, Test Condition A. high RH (95%) and elevated temperature (40°C) for 240 hours. |
| Salt Spray | MIL-STD-202G, Method 101D, Test Condition B |

Dimensions

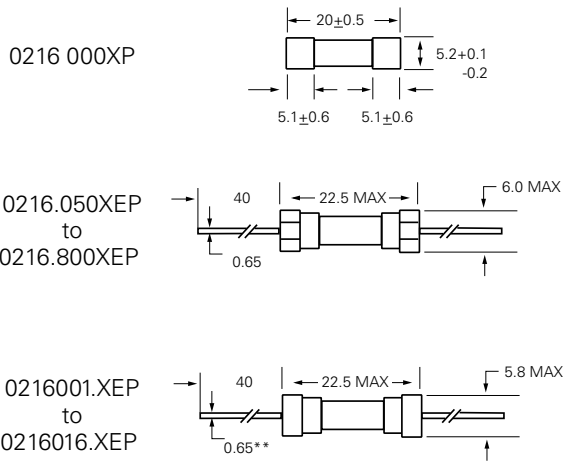

All dimensions in mm
** Ratings above 6.3A have 0.8 mm diameter lead

Part Numbering System

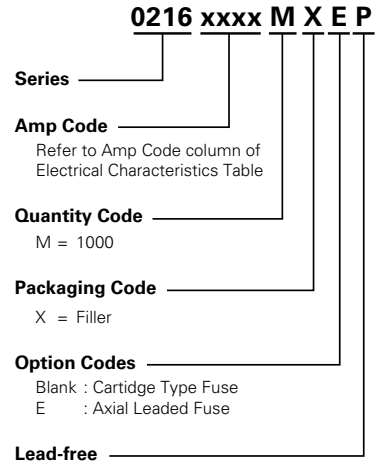

Packaging

| Packaging Option | Packaging Specification | Quantity | Quantity & Packaging Code | Taping Width |
|-------------------|-------------------------|----------|---------------------------|------------------|
| 216 Series | | | | |
| Bulk | N/A | 1000 | MX | N/A |
| Bulk | N/A | 1000 | MXE | N/A |
| Reel and Tape | EIA 296-E | 1000 | MRET1 | T1=52mm (2.062") |
| Bulk | N/A | 1000 | MXG | N/A |
| Bulk | N/A | 1000 | MXB | N/A |
| Bulk | N/A | 100 | HX | N/A |