

General Description

The AO6804A uses advanced trench technology to provide excellent $R_{DS(ON)}$, low gate charge and operation with gate voltages as low as 2.5V. This device is suitable for use as a load switch applications.

Product Summary

$$V_{DS} = 20V$$

$$I_D = 5.0A \quad (V_{GS} = 4.5V)$$

$$R_{DS(ON)} < 28m\Omega \quad (V_{GS} = 4.5V)$$

$$R_{DS(ON)} < 30m\Omega \quad (V_{GS} = 4.0V)$$

$$R_{DS(ON)} < 34m\Omega \quad (V_{GS} = 3.1V)$$

$$R_{DS(ON)} < 39m\Omega \quad (V_{GS} = 2.5V)$$

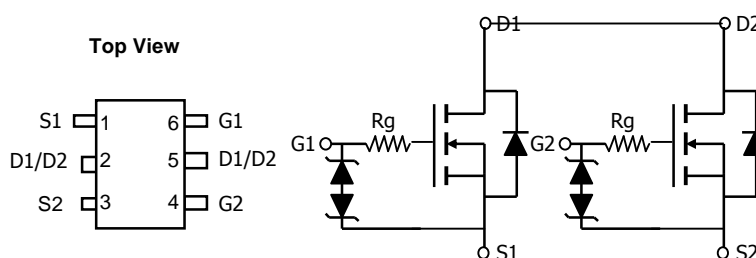

Absolute Maximum Ratings $T_A=25^\circ C$ unless otherwise noted

Parameter	Symbol	Maximum	Units
Drain-Source Voltage	V_{DS}	20	V
Gate-Source Voltage	V_{GS}	± 12	V
Continuous Drain Current ^A	I_D	$T_A=25^\circ C$	5
		$T_A=70^\circ C$	4
Pulsed Drain Current ^B	I_{DM}	25	A
Power Dissipation ^A	P_D	$T_A=25^\circ C$	1.3
		$T_A=70^\circ C$	0.8
Junction and Storage Temperature Range	T_J, T_{STG}	-55 to 150	$^\circ C$

Thermal Characteristics

Parameter	Symbol	Typ	Max	Units
Maximum Junction-to-Ambient ^A	$R_{\theta JA}$	76	95	$^\circ C/W$
Maximum Junction-to-Ambient ^A		Steady State	118	150
Maximum Junction-to-Lead ^C	$R_{\theta JL}$	54	68	$^\circ C/W$

Electrical Characteristics (T_J=25°C unless otherwise noted)

Symbol	Parameter	Conditions	Min	Typ	Max	Units
STATIC PARAMETERS						
BV _{DSS}	Drain-Source Breakdown Voltage	I _D = 250μA, V _{GS} = 0V	20			V
I _{DSS}	Zero Gate Voltage Drain Current	V _{DS} = 20V, V _{GS} = 0V T _J = 55°C			1 5	μA
I _{GSS}	Gate-Body leakage current	V _{DS} = 0V, V _{GS} = ±10V			±10	μA
V _{GS(th)}	Gate Threshold Voltage	V _{DS} = V _{GS} , I _D = 250μA	0.5	0.7	1	V
I _{D(ON)}	On state drain current	V _{GS} = 4.5V, V _{DS} = 5V	25			A
R _{DS(ON)}	Static Drain-Source On-Resistance	V _{GS} = 4.5V, I _D = 5.0A T _J = 125°C	18 26	23 33	28 40	mΩ
		V _{GS} = 4.0V, I _D = 4.5A	19	24	30	
		V _{GS} = 3.1V, I _D = 4.5A	20	27	34	mΩ
		V _{GS} = 2.5V, I _D = 4.0A	21	30	39	mΩ
		g _{FS}	Forward Transconductance	V _{DS} = 5V, I _D = 5.0A		18
V _{SD}	Diode Forward Voltage	I _S = 1A, V _{GS} = 0V		0.65	1	V
I _S	Maximum Body-Diode Continuous Current				1.3	A
DYNAMIC PARAMETERS						
C _{iss}	Input Capacitance	V _{GS} = 0V, V _{DS} = 10V, f = 1MHz		180	225	pF
C _{oss}	Output Capacitance			95		pF
C _{rss}	Reverse Transfer Capacitance			18		pF
R _g	Gate resistance	V _{GS} = 0V, V _{DS} = 0V, f = 1MHz		2.7	4	kΩ
SWITCHING PARAMETERS						
Q _g	Total Gate Charge	V _{GS} = 4.5V, V _{DS} = 10V, I _D = 5A		5.6	7.5	nC
Q _{gs}	Gate Source Charge			0.85		nC
Q _{gd}	Gate Drain Charge			1.7		nC
t _{D(on)}	Turn-On DelayTime	V _{GS} = 10V, V _{DS} = 10V, R _L = 2.0Ω, R _{GEN} = 3Ω		172		ns
t _r	Turn-On Rise Time			368		ns
t _{D(off)}	Turn-Off DelayTime			2.94		μs
t _f	Turn-Off Fall Time			2.5		μs
t _{rr}	Body Diode Reverse Recovery Time		I _F = 5A, di/dt = 100A/μs		32	43
Q _{rr}	Body Diode Reverse Recovery Charge	I _F = 5A, di/dt = 100A/μs		3.2		nC

A: The value of R_{θJA} is measured with the device mounted on 1 in² FR-4 board with 2oz. Copper, in a still air environment with T_A = 25°C. in any given application depends on the user's specific board design. The current rating is based on the t ≤ 10s thermal resistance rating.

B: Repetitive rating, pulse width limited by junction temperature.

C: The R_{θJA} is the sum of the thermal impedance from junction to lead R_{θJL} and lead to ambient.

D: The static characteristics in Figures 1 to 6 are obtained using < 300μs pulses, duty cycle 0.5% max.

E: These tests are performed with the device mounted on 1 in² FR-4 board with 2oz. Copper, in a still air environment with T_A = 25°C. The SOA curve provides a single pulse rating.

Rev2: Nov. 2010

TYPICAL ELECTRICAL AND THERMAL CHARACTERISTICS

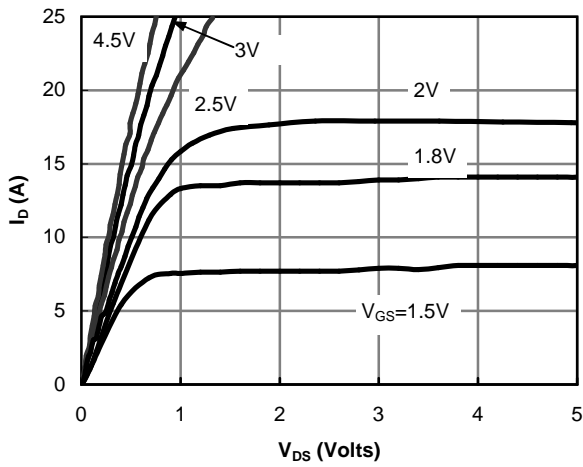

Figure 1: On-Region Characteristics

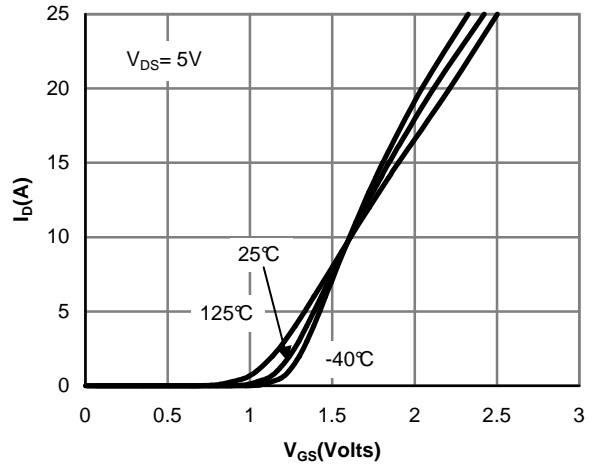

Figure 2: Transfer Characteristics

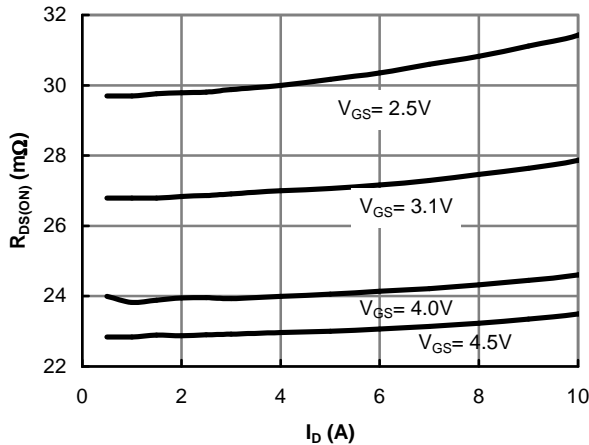

Figure 3: On-Resistance vs. Drain Current and Gate Voltage

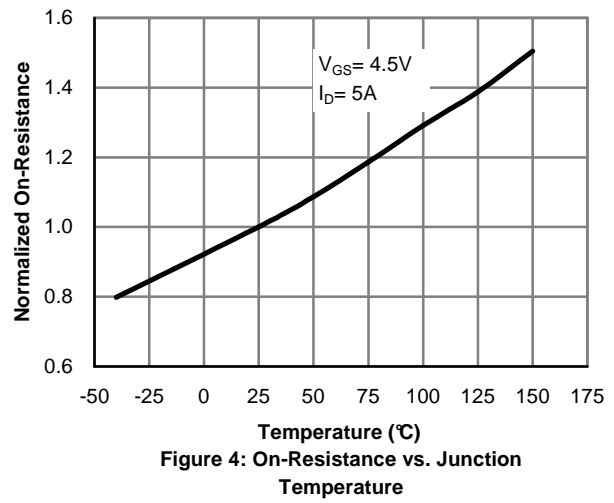

Figure 4: On-Resistance vs. Junction Temperature

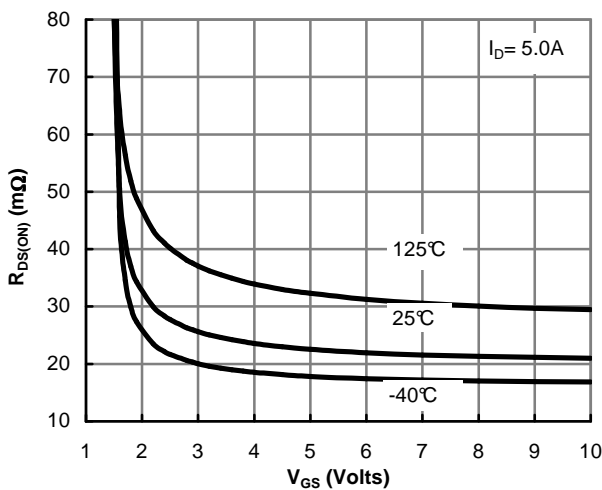

Figure 5: On-Resistance vs. Gate-Source Voltage

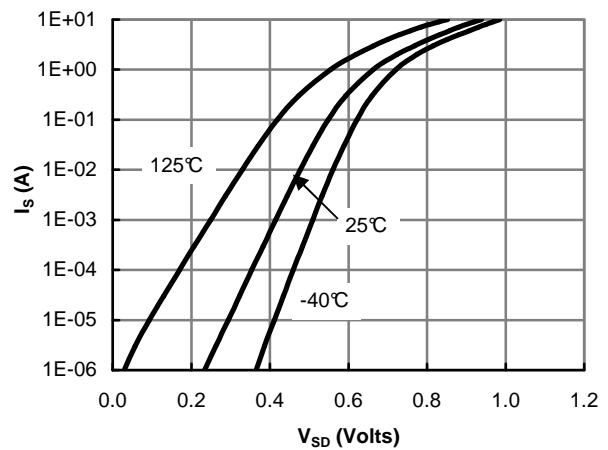

Figure 6: Body-Diode Characteristics

TYPICAL ELECTRICAL AND THERMAL CHARACTERISTICS

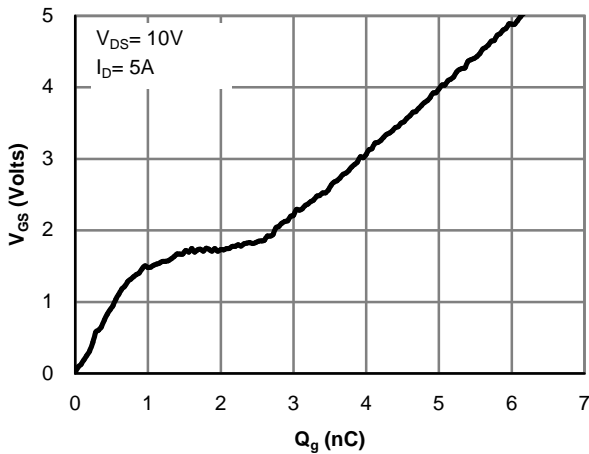

Figure 7: Gate-Charge Characteristics

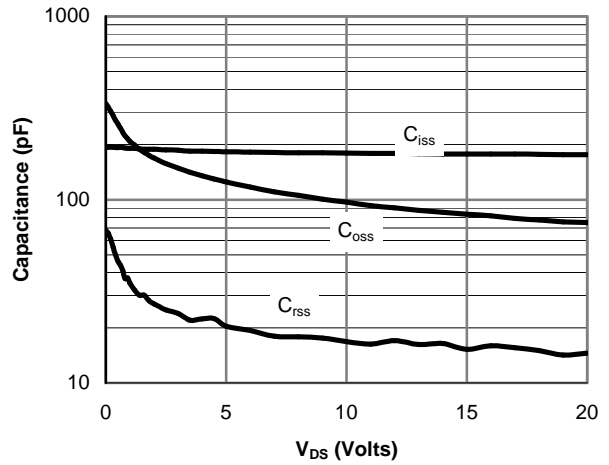

Figure 8: Capacitance Characteristics

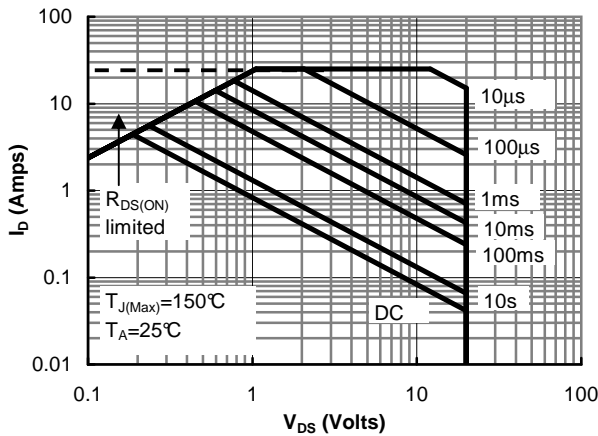

Figure 9: Maximum Forward Biased Safe Operating Area (Note E)

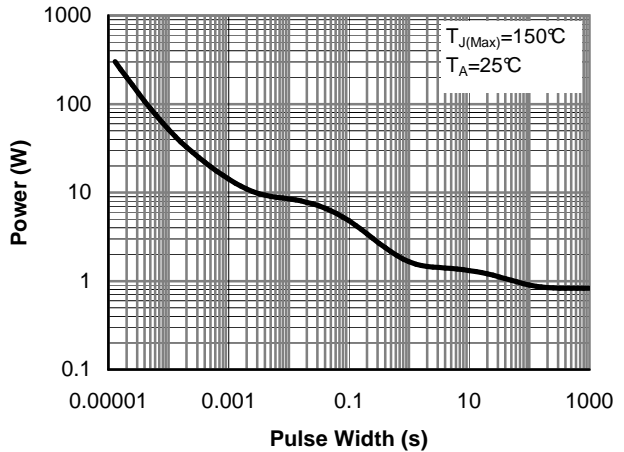

Figure 10: Single Pulse Power Rating Junction-to-Ambient (Note E)

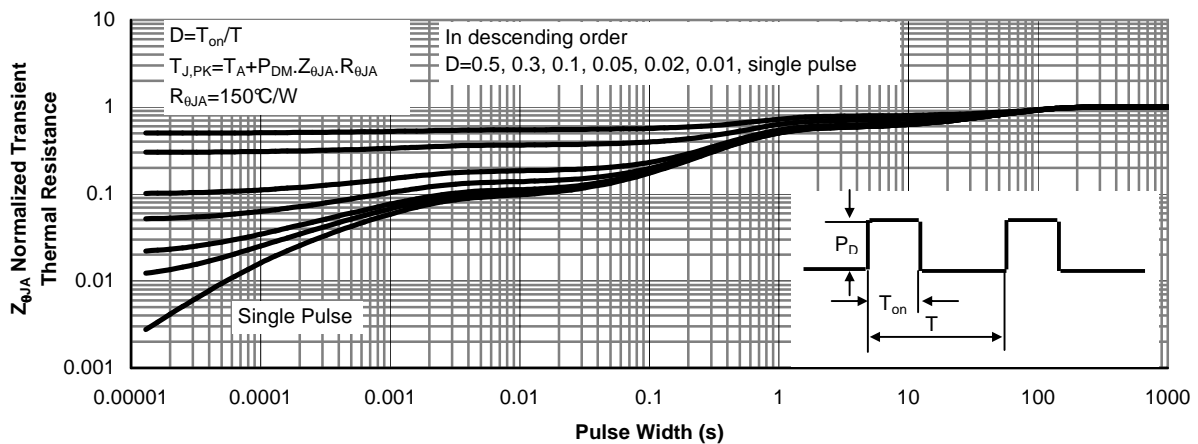
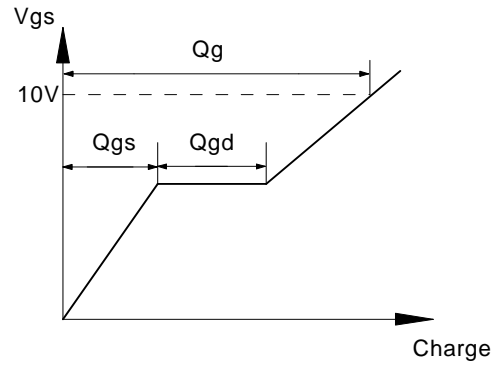
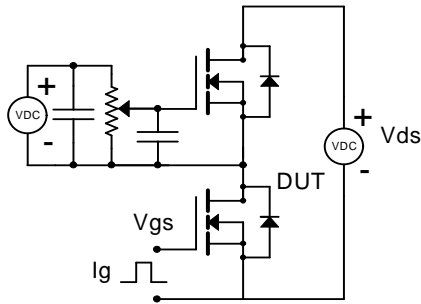
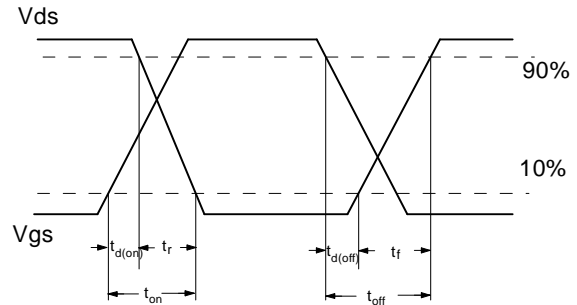
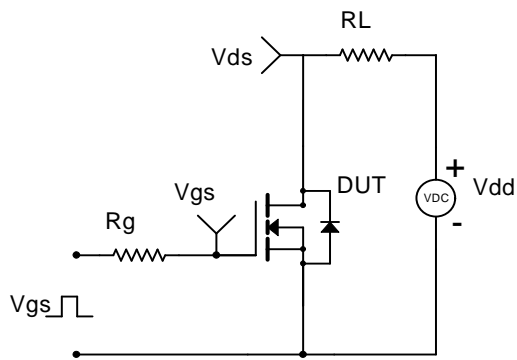

Figure 11: Normalized Maximum Transient Thermal Impedance (Note E)

Gate Charge Test Circuit & Waveform



Resistive Switching Test Circuit & Waveforms



Diode Recovery Test Circuit & Waveforms

