

APPLICATIONS

The DGT409BCA is a symmetrical GTO designed for applications, which specifically require a reverse blocking capability, such as current source inverter (CSI). Reverse recovery ratings and characteristics are included.

FEATURES

- Reverse blocking Capability
- Double Side Cooling
- High Reliability In Service
- High Voltage Capability
- Fault Protection Without Fuses
- Turn-off Capability Allows Reduction in Equipment Size and Weight. Low Noise Emission Reduces Acoustic Cladding Necessary For Environmental Requirements

ORDERING INFORMATION

Order as: **DGT409BCA6565**

KEY PARAMETERS

I_{TCM}	1500A
V_{DRM}/V_{RRM}	6500V
dV_D/dt	1000V/μs
dI_T/dt	300A/μs

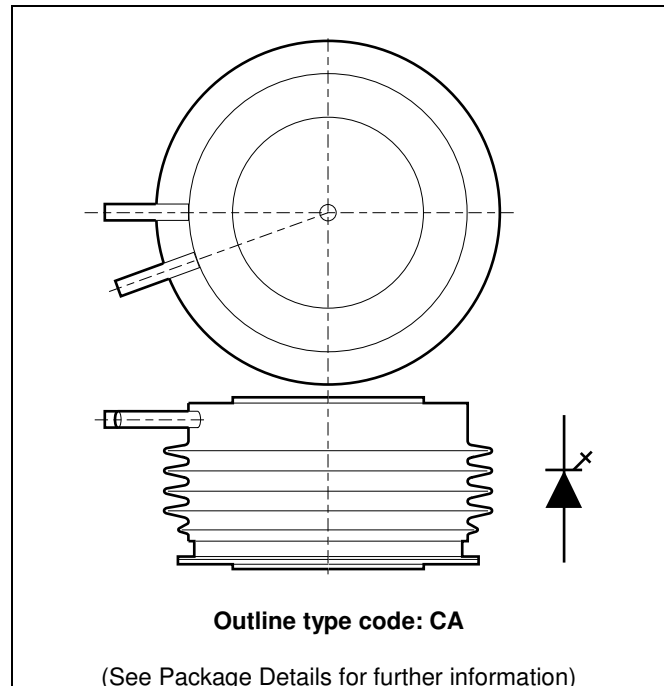

Fig. 1 Package outline

VOLTAGE RATINGS

Type Number	Repetitive Peak Off-state Voltage V_{DRM} (V)	Repetitive Peak Reverse Voltage V_{RRM} (V)	Conditions
DGT409BCA	6500	6500	$T_{vj} = 115^{\circ}\text{C}$, $I_{DM} =$, $I_{RRM} = 100\text{mA}$

CURRENT RATINGS

Symbol	Parameter	Conditions	Max.	Units
I_{TCM}	Repetitive peak controllable on-state current	$V_D = 4300\text{V}$, $T_j = 115^{\circ}\text{C}$, $di_{GQ}/dt = 20\text{A}/\mu\text{s}$, $C_S = 2 \mu\text{F}$	1500	A

SURGE RATINGS

Symbol	Parameter	Test Conditions	Max.	Units
I_{TSM}	Surge (non repetitive) on-state current	10ms half sine. $T_j = 115^{\circ}\text{C}$	3.0	kA
I^2t	I^2t for fusing	10ms half sine. $T_j = 115^{\circ}\text{C}$	45	kA^2s
di_T/dt	Critical rate of rise of on-state current	$V_D = 3000\text{V}$, $I_T = 800\text{A}$, $T_j = 115^{\circ}\text{C}$, $I_{FG} > 20\text{A}$, Rise time (t_r) $> 1.5 \mu\text{s}$	300	$\text{A}/\mu\text{s}$
dV_D/dt	Rate of rise of off-state voltage	$V_D = 3000\text{V}$; $R_{GK} \leq 1.5\Omega$, $T_j = 115^{\circ}\text{C}$	175	$\text{V}/\mu\text{s}$
		$V_D = 3000\text{V}$; $V_{RG} \leq -2\text{V}$, $T_j = 115^{\circ}\text{C}$	1000	$\text{V}/\mu\text{s}$
L_s	Peak stray inductance in snubber circuit	$I_T = 1500\text{A}$, $V_{DM} = 6000\text{V}$, $T_j = 115^{\circ}\text{C}$, $di_{GQ} = 20\text{A}/\mu\text{s}$, $C_S = 2.0\mu\text{F}$	200	nH

GATE RATINGS

Symbol	Parameter	Test Conditions	Min.	Max.	Units
V_{RGM}	Peak reverse gate voltage	This value may exceeded during turn-off	-	25	V
I_{FGM}	Peak forward gate current		20	70	A
$P_{FG(AV)}$	Average forward gate power		-	10	W
P_{RGM}	Peak reverse gate power		-	15	kW
di_{GQ}/dt	Rate of rise of reverse gate current		15	60	$\text{A}/\mu\text{s}$
$t_{ON(\text{min})}$	Minimum permissible on time		50	-	μs
$t_{OFF(\text{min})}$	Minimum permissible off time		150	-	μs
I_{RGM}	Continuous reverse gate-cathode current	$V_{RGM} = 16\text{V}$, No gate cathode resistor	-	50	mA

THERMAL AND MECHANICAL RATINGS

Symbol	Parameter	Test Conditions		Min.	Max.	Units
$R_{th(j-hs)}$	Thermal resistance – junction to heatsink surface	Double side cooled	DC	-	0.046	°C/W
		Single side cooled	Anode DC	-	0.073	°C/W
			Cathode DC	-	0.124	°C/W
$R_{th(c-hs)}$	Contact thermal resistance	Clamping force 32.0kN With mounting compound	Per contact	-	0.009	°C/W
T_{vj}	Virtual junction temperature	On-state (conducting)		-	115	°C
T_{op}/T_{stg}	Operating junction/storage temperature range			-40	115	°C
F_m	Clamping force			11.0	15.0	kN

CHARACTERISTICS
 $T_j = 115^\circ\text{C}$ unless stated otherwise

Symbol	Parameter	Test Conditions	Min.	Max.	Units	
V_{TM}	On-state voltage	At 200A peak, $I_{G(ON)} = 4A$ d.c.	-	4	V	
I_{DM}	Peak off-state current	$V_{DRM} = 6500V$, $V_{RG} = 0V$	-	100	mA	
I_{RRM}	Peak reverse current	$V_{RRM} = 6500V$	-	100	mA	
V_{GT}	Gate trigger voltage	$V_D = 24V$, $I_T = 100A$, $T_j = 25^\circ\text{C}$	-	1	V	
I_{GT}	Gate trigger current	$V_D = 24V$, $I_T = 100A$, $T_j = 25^\circ\text{C}$	-	2	A	
I_{RGM}	Reverse gate cathode current	$V_{RGM} = 16V$, No gate/cathode resistor	-	50	mA	
E_{ON}	Turn-on Energy	$V_D = 3000V$	-	2500	mJ	
t_d	Delay time	$I_T = 400A$, $dI_T/dt = 150A/\mu s$	-	3	μs	
t_r	Rise time	$I_{FG} = 20A$, rise time (t_r) < 1.5 μs	-	7	μs	
E_{OFF}	Turn-off energy	$I_T = 800A$, $V_{DM} = 3000V$ Snubber Cap $C_s = 2\mu C$ $di_{GQ}/dt = 20A/\mu s$	-	2500	mJ	
t_{gs}	Storage time		See Fig.17 and Fig.18			μs
t_{gf}	Fall time					μs
t_{gq}	Gate controlled turn-off time					μs
Q_{GQ}	Turn-off gate charge		-	3600	μC	
Q_{GQT}	Total turn-off gate charge	-	7200	μC		
I_{GQM}	Peak reverse gate current	-	350	A		

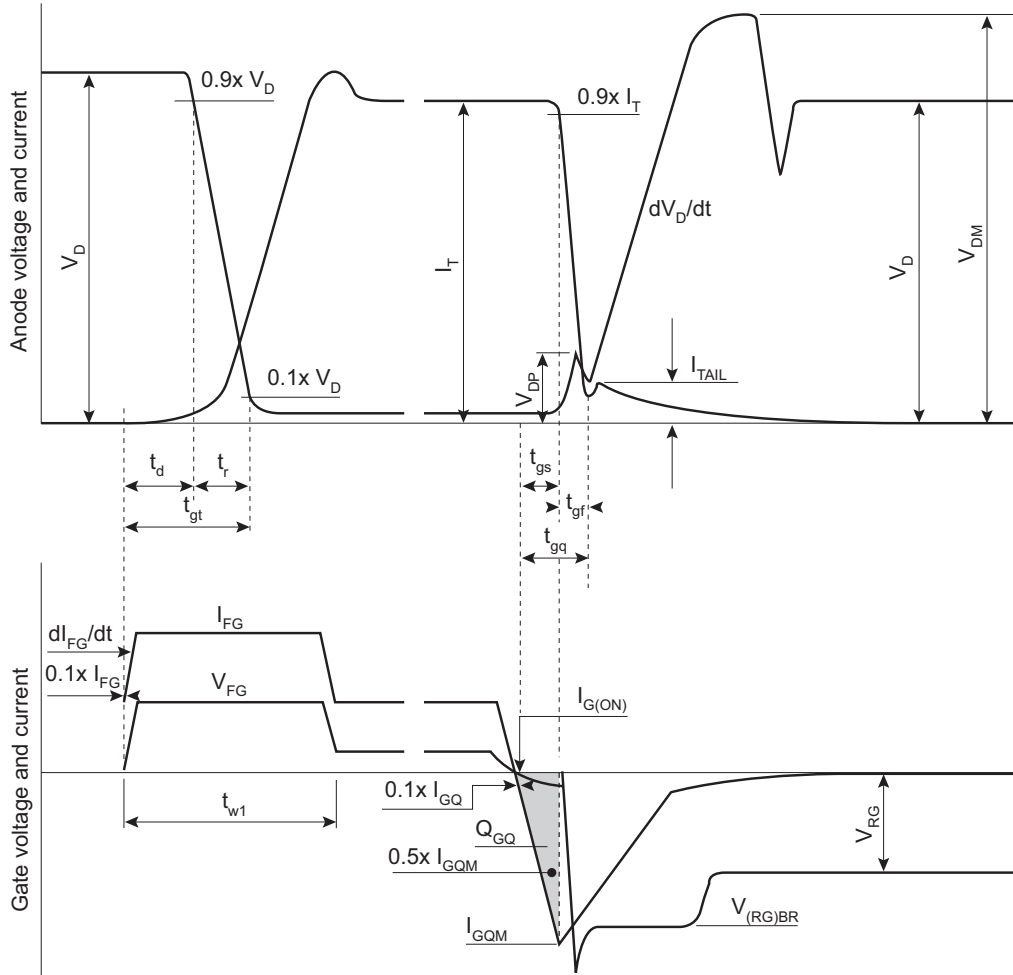

Recommended gate conditions to switch off $I_{TCM} = 800A$:

- $I_{FG} = 30A$
- $I_{G(ON)} = 4A$ d.c.
- $t_{w1(min)} = 20\mu s$
- $I_{GQM} = 270A$ typical
- $di_{GQ}/dt = 30A/\mu s$
- $Q_{GQ} = 2200\mu C$
- $V_{RG(min)} = 2V$
- $V_{RG(max)} = 15V$

These are recommended Dynex Semiconductor conditions. Other conditions are permitted according to users gate drive specifications.

Fig.2 General switching waveforms

CURVES

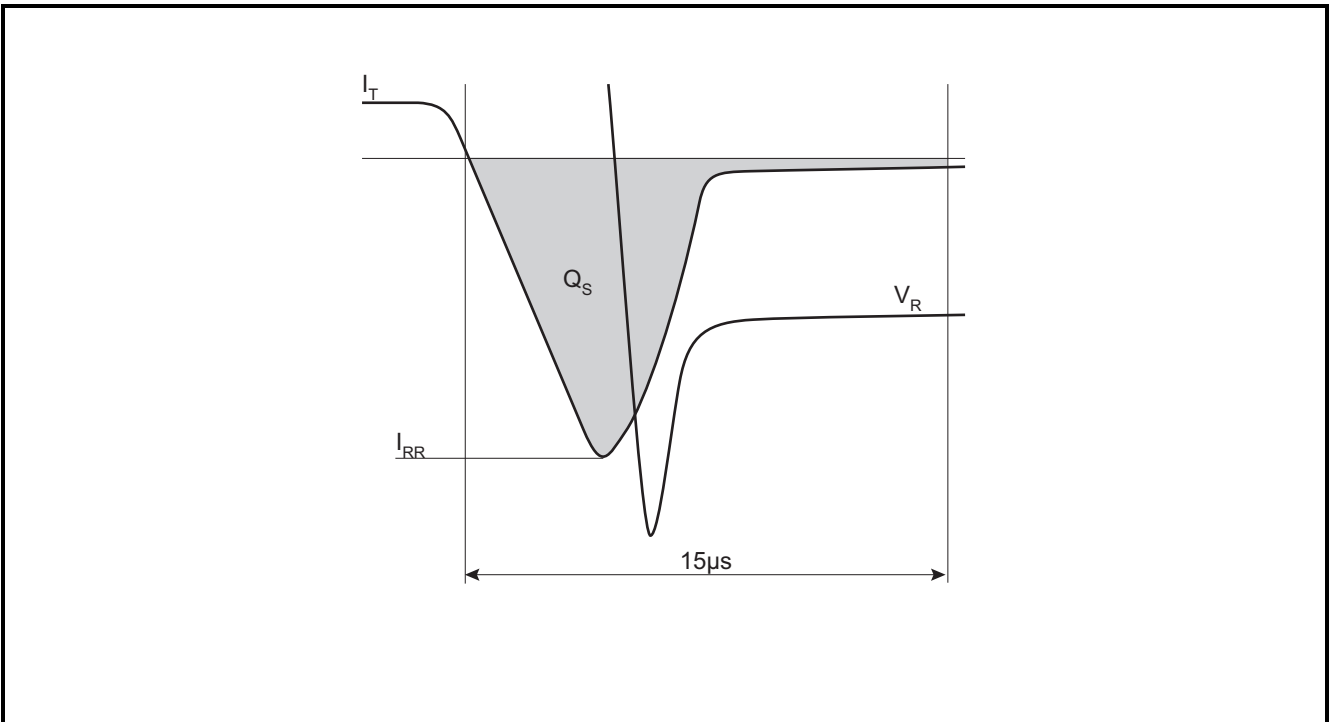

Fig.3 Reverse recovery waveforms

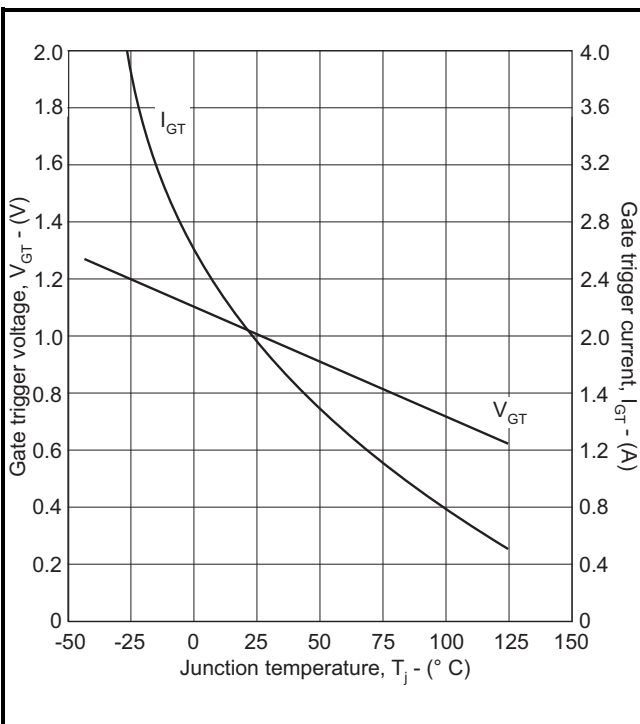

Fig.4 Maximum gate trigger voltage/current vs junction temperature

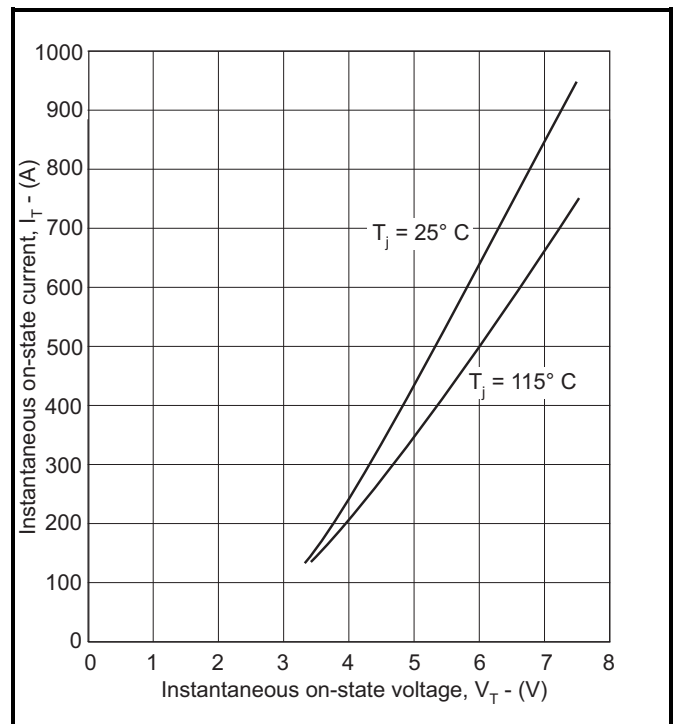

Fig.5 Maximum on-state characteristics

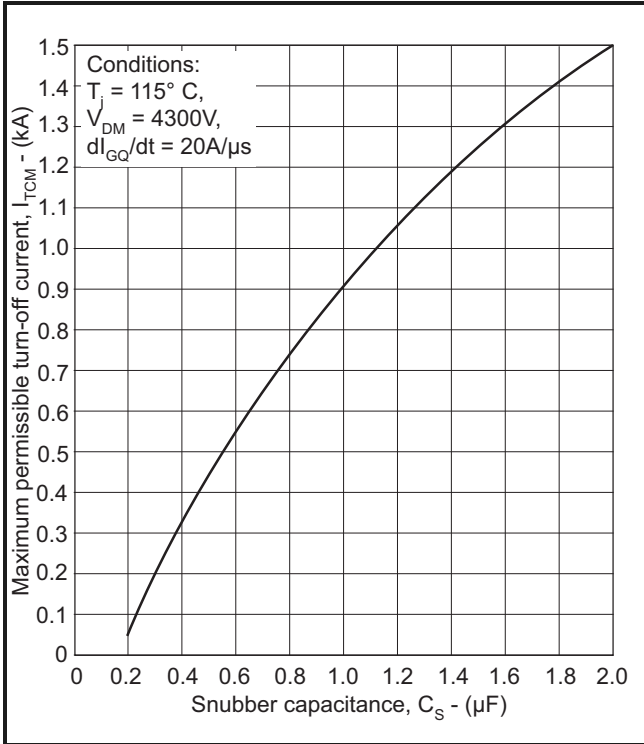

Fig.6 Maximum dependence of I_{TCM} on C_S

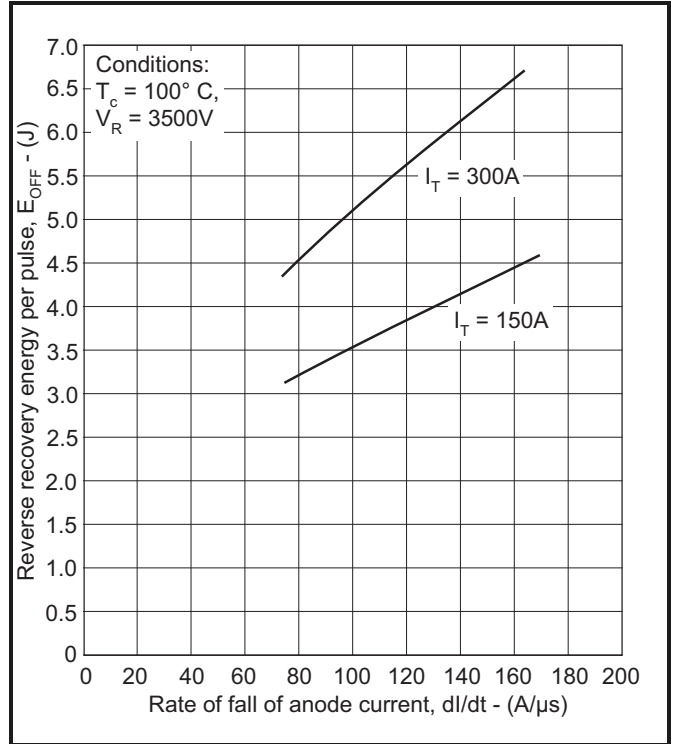

Fig.7 Maximum reverse recovery energy vs rate of fall of anode current

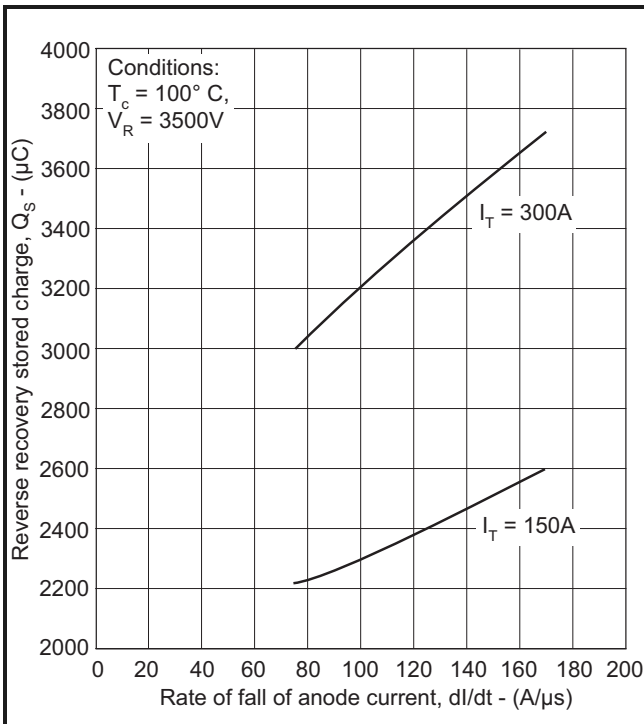

Fig.8 Maximum reverse recovery charge vs rate of fall of anode current

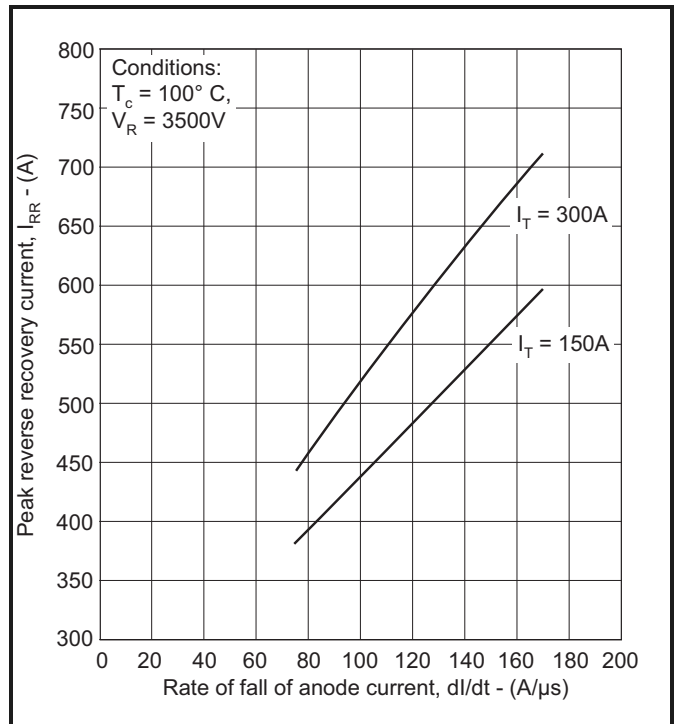

Fig.9 Maximum reverse recovery current vs rate of fall of anode current

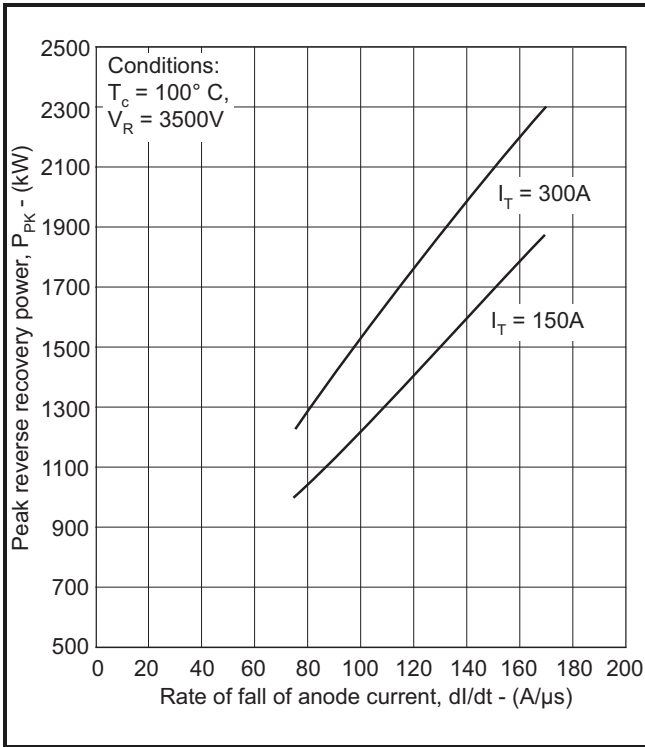

Fig.10 Maximum reverse recovery power vs rate of fall of anode current

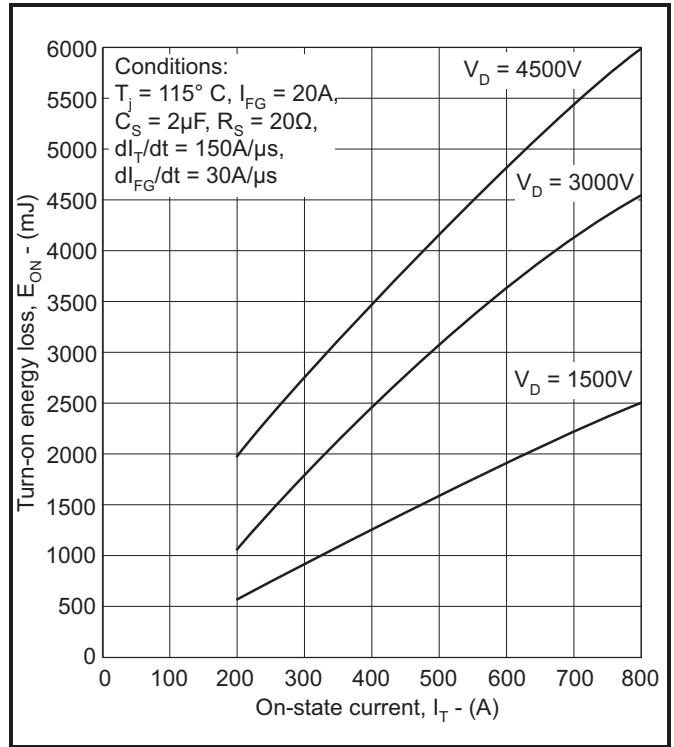

Fig.11 Turn-on energy vs on-state current

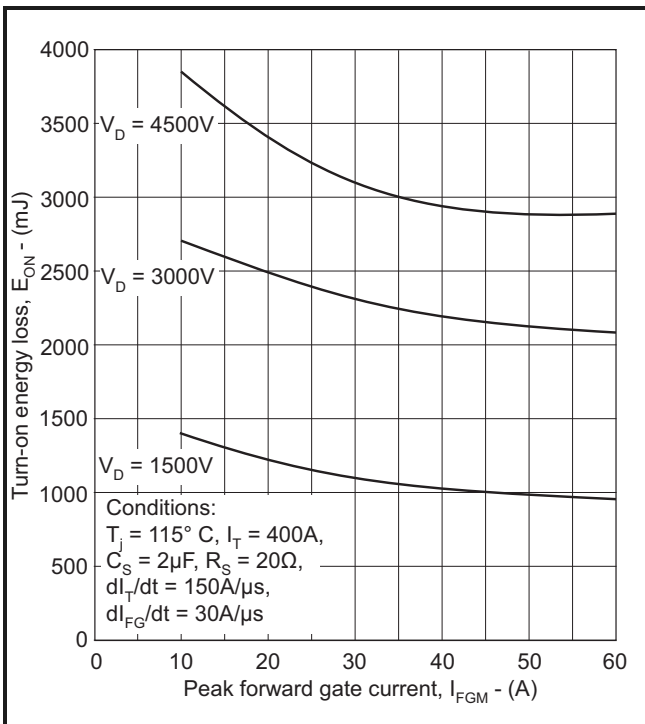

Fig.12 Turn-on energy vs peak forward gate current

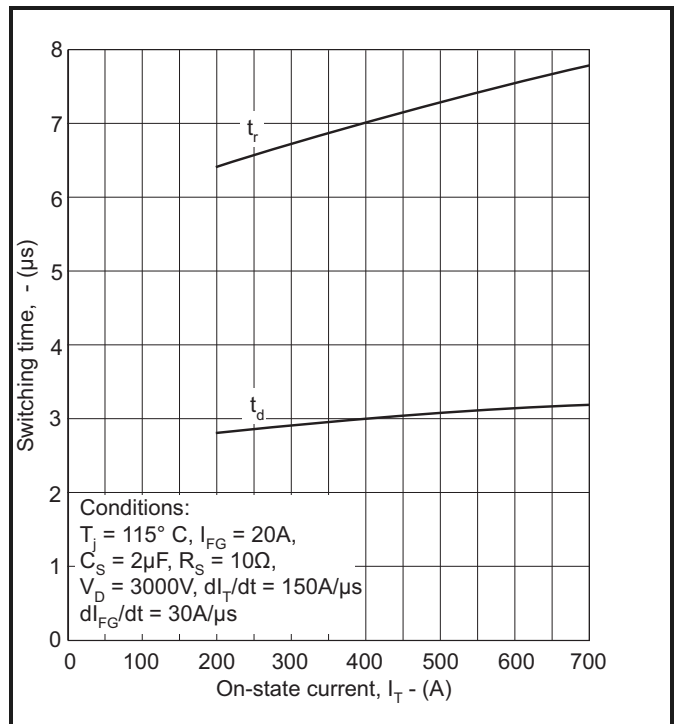

Fig.13 Delay time and rise time vs on-state current

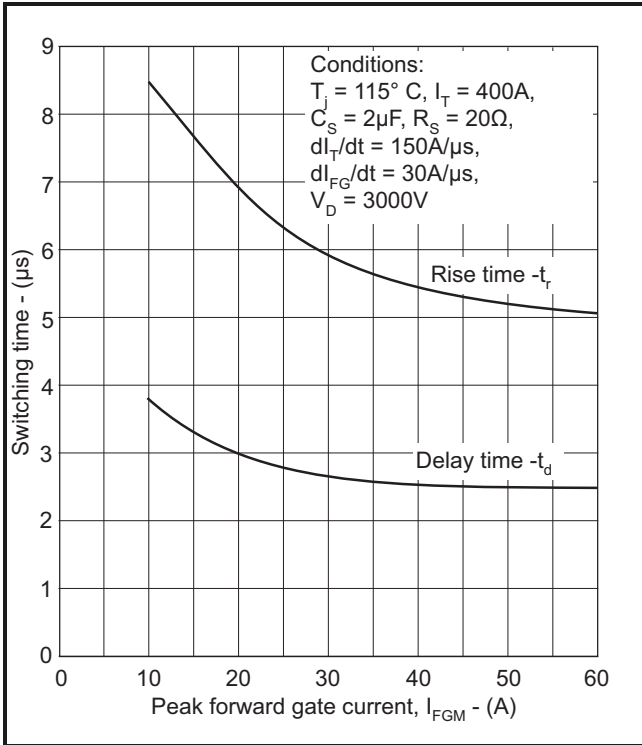

Fig.14 Switching times vs peak forward gate current

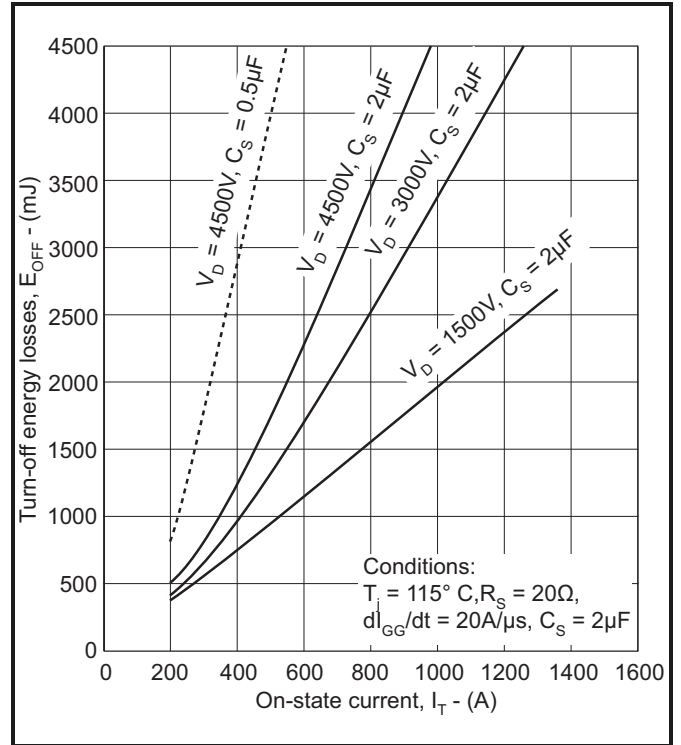

Fig.15 Maximum turn-off energy vs on-state current

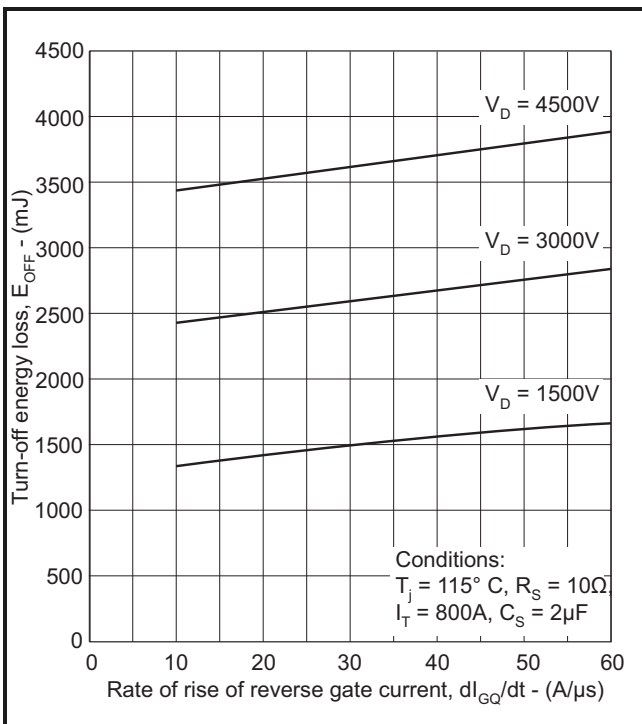

Fig.16 Turn-off energy vs rate of rise of reverse gate current

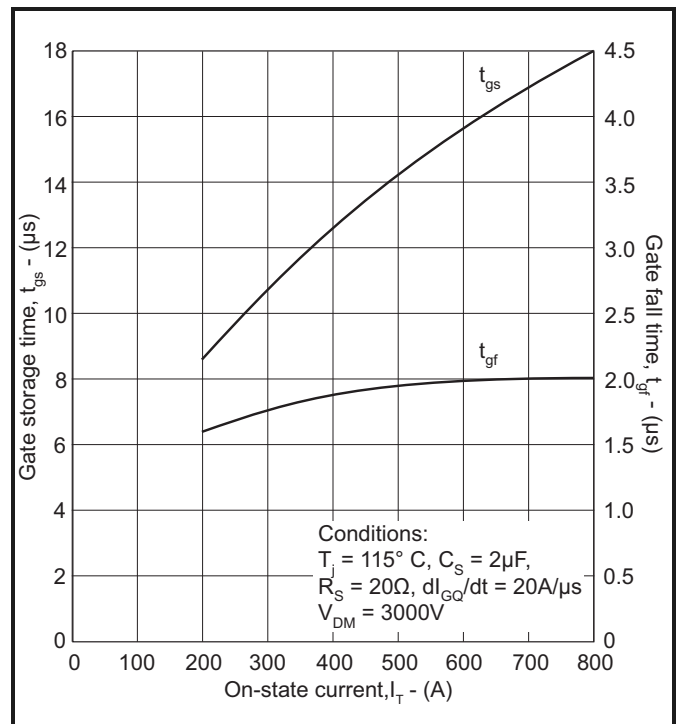

Fig.17 Gate storage time and fall time vs on-state current

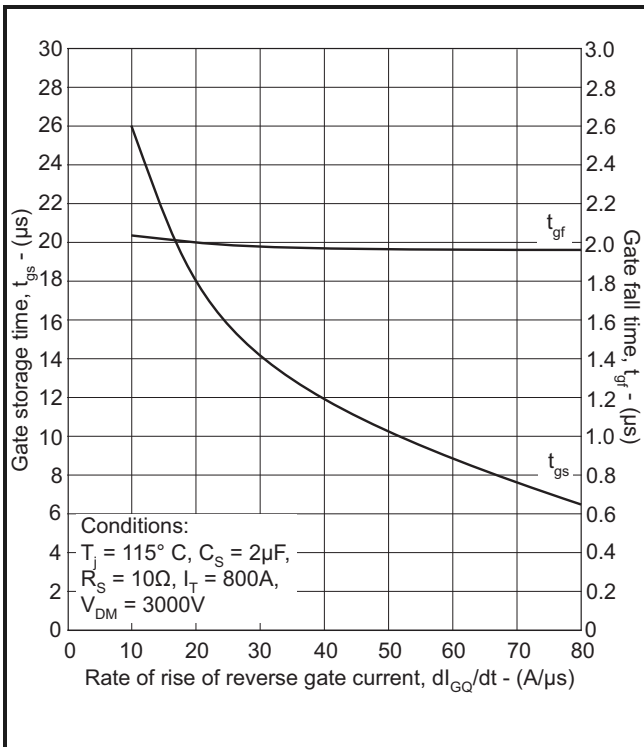

Fig.18 Gate storage time and fall time vs rate of rise of reverse gate current

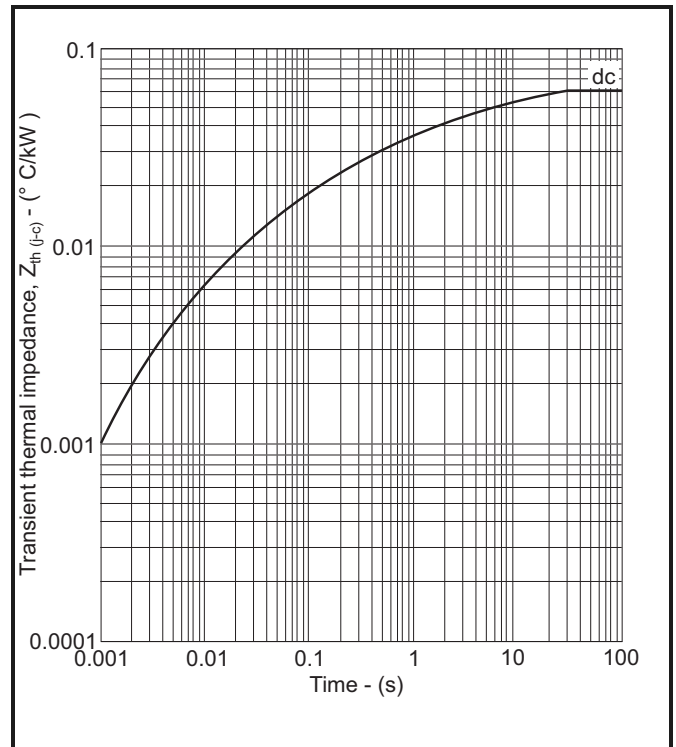

Fig.19 Maximum (limit) transient thermal impedance – double side cooled

PACKAGE DETAILS

For further package information, please contact Customer Services. All dimensions in mm, unless stated otherwise. DO NOT SCALE.

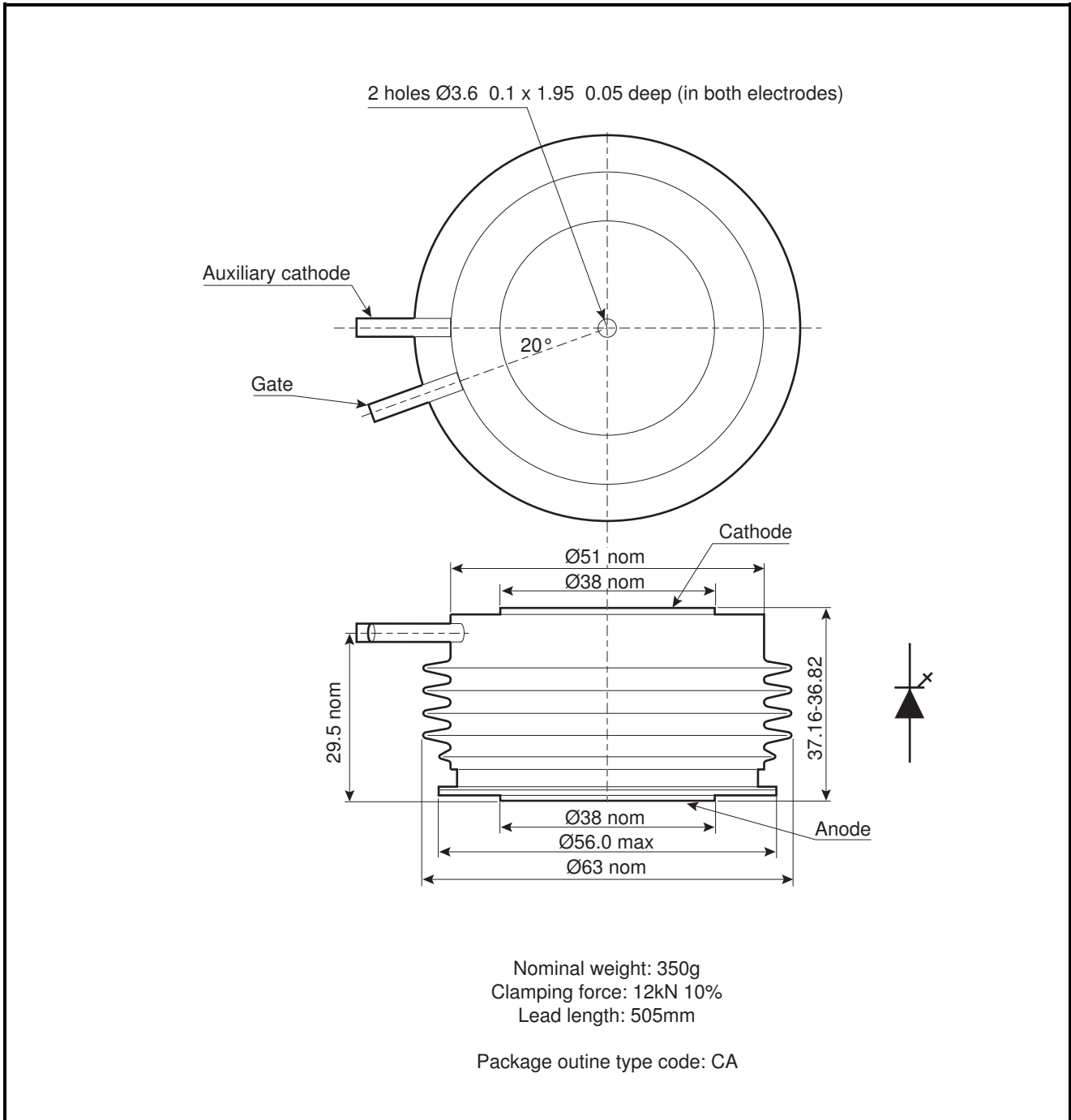

Fig.20 Package outline

POWER ASSEMBLY CAPABILITY

The Power Assembly group was set up to provide a support service for those customers requiring more than the basic semiconductor, and has developed a flexible range of heatsink and clamping systems in line with advances in device voltages and current capability of our semiconductors.

We offer an extensive range of air and liquid cooled assemblies covering the full range of circuit designs in general use today. The Assembly group offers high quality engineering support dedicated to designing new units to satisfy the growing needs of our customers.

Using the latest CAD methods our team of design and applications engineers aim to provide the Power Assembly Complete Solution (PACs).

HEATSINKS

The Power Assembly group has its own proprietary range of extruded aluminium heatsinks which have been designed to optimise the performance of Dynex semiconductors. Data with respect to air natural, forced air and liquid cooling (with flow rates) is available on request.

For further information on device clamps, heatsinks and assemblies, please contact your nearest sales representative or Customer Services.

Stresses above those listed in this data sheet may cause permanent damage to the device. In extreme conditions, as with all semiconductors, this may include potentially hazardous rupture of the package. Appropriate safety precautions should always be followed.



<http://www.dynexsemi.com>

e-mail: power_solutions@dynexsemi.com

**HEADQUARTERS OPERATIONS
DYNEX SEMICONDUCTOR LTD**
Doddington Road, Lincoln
Lincolnshire, LN6 3LF. United Kingdom.
Tel: +44(0)1522 500500
Fax: +44(0)1522 500550

CUSTOMER SERVICE
Tel: +44(0)1522 502753 / 502901. Fax: +44(0)1522 500020

© Dynex Semiconductor 2003 TECHNICAL DOCUMENTATION – NOT FOR
RESALE. PRODUCED IN UNITED KINGDOM.

This publication is issued to provide information only which (unless agreed by the Company in writing) may not be used, applied or reproduced for any purpose nor form part of any order or contract nor to be regarded as a representation relating to the products or services concerned. No warranty or guarantee express or implied is made regarding the capability, performance or suitability of any product or service. The Company reserves the right to alter without prior notice the specification, design or price of any product or service. Information concerning possible methods of use is provided as a guide only and does not constitute any guarantee that such methods of use will be satisfactory in a specific piece of equipment. It is the user's responsibility to fully determine the performance and suitability of any equipment using such information and to ensure that any publication or data used is up to date and has not been superseded. These products are not suitable for use in any medical products whose failure to perform may result in significant injury or death to the user. All products and materials are sold and services provided subject to the Company's conditions of sale, which are available on request.

All brand names and product names used in this publication are trademarks, registered trademarks or trade names of their respective owners.